

MAX mobile router

User Manual

Pepwave MAX Series:

MAX 600 / 700 / HD2

Pepwave MAX Firmware 5.4

July 2013

COPYRIGHT & TRADEMARKS

Specifications are subject to change without notice. Copyright © 2013 Pepwave Ltd. All Rights Reserved. Pepwave and the Pepwave logo are trademarks of Pepwave Ltd. Other brands or products mentioned may be trademarks or registered trademarks of their respective owners.

User Manual

PEPWAVE *MAX* mobile router

Table of Contents

1	INTRODUCTION AND SCOPE	5
2	GLOSSARY	6
3	PRODUCT FEATURES	7
3.1	SUPPORTED NETWORK FEATURES	7
3.2	OTHER SUPPORTED FEATURES	8
4	PEPWAVE MAX MOBILE ROUTER OVERVIEW	9
4.1	MAX 600	9
4.2	MAX 700	11
4.3	MAX HD2.....	13
5	INSTALLATION	15
5.1	PREPARATION	15
5.2	CONSTRUCTING THE NETWORK.....	15
5.3	CONFIGURING THE NETWORK ENVIRONMENT	16
5.4	MOUNTING THE UNIT	16
6	CONNECTING TO WEB ADMIN INTERFACE	18
7	CONFIGURATION OF LAN INTERFACE(S)	20
7.1	BASIC SETTINGS	20
7.2	WI-FI AP.....	24
8	CONFIGURATION OF WAN INTERFACE(S)	26
8.1	ETHERNET WAN	27
8.2	CELLULAR 1 / CELLULAR 2	36
8.3	WI-FI WAN	39
8.4	WAN HEALTH CHECK	44
8.5	BANDWIDTH ALLOWANCE MONITOR	48
9	WI-FI SETTINGS	49
10	BANDWIDTH BONDING SPEEDFUSION™	52
10.1	SPEEDFUSION™	53
10.2	LINK FAILURE DETECTION	57
10.3	PEPWAVE MAX BEHIND NAT ROUTER	58
10.4	SPEEDFUSION™ STATUS.....	59
11	IPSEC VPN	60
11.1	IPSEC VPN SETTINGS	60
11.2	IPSEC STATUS	63
12	MANAGEMENT OF OUTBOUND TRAFFIC TO WAN	63
12.1	OUTBOUND POLICY	63

User Manual

PEPWAVE *MAX* mobile router

12.2	CUSTOM RULES FOR OUTBOUND POLICY	64
13	PORT FORWARDING	74
13.1	PORT FORWARDING SERVICE	74
13.2	UPNP / NAT-PMP SETTINGS.....	76
14	NAT MAPPINGS	77
15	QOS.....	79
15.1	USER GROUPS.....	79
15.2	BANDWIDTH CONTROL	80
15.3	APPLICATION	81
16	FIREWALL.....	83
16.1	OUTBOUND AND INBOUND FIREWALL	83
16.2	INTRUSION DETECTION AND DoS PREVENTION	87
17	MISCELLANEOUS SETTINGS	88
17.1	PPTP SERVER	88
17.2	SERVICE FORWARDING	89
17.3	SERVICE PASSTHROUGH	91
18	SYSTEM SETTINGS.....	92
18.1	ADMIN SECURITY	92
18.2	FIRMWARE UPGRADE.....	96
18.3	TIME.....	96
18.4	EMAIL NOTIFICATION	97
18.5	REMOTE SYSLOG.....	100
18.6	SNMP	101
18.7	INCONTROL	103
18.8	CONFIGURATION.....	104
18.9	REBOOT.....	105
18.10	PING TEST	106
18.11	TRACEROUTE TEST.....	107
18.12	SPEEDFUSION™ TEST.....	107
18.13	CLI (COMMAND LINE INTERFACE SUPPORT).....	108
19	STATUS	109
19.1	DEVICE	109
19.2	ACTIVE SESSIONS	111
19.3	CLIENT LIST	112
19.4	WINS CLIENT	113
19.5	SPEEDFUSION™	113
19.6	UPNP / NAT-PMP	114
19.7	EVENT LOG.....	115
19.8	BANDWIDTH	116
APPENDIX A.	RESTORATION OF FACTORY DEFAULTS.....	119

User Manual

PEPWAVE *MAX* mobile router

APPENDIX B. DECLARATION.....	120
------------------------------	-----

User Manual

PEPWAVE *MAX* mobile router

1 Introduction and Scope

The Pepwave MAX Mobile Router provides link aggregation and load balancing across multiple WAN connections, allowing a combination of technologies like 3G HSDPA, EVDO, 4G LTE, Wi-Fi, external WiMAX dongle, and Satellite to be utilized to connect to the Internet.

This manual presents how to set up the Pepwave MAX Mobile Router and provides an introduction to the features and usage of Pepwave MAX Mobile Router.

Tips

Want to know more about Pepwave MAX? Visit our [YouTube Channel](#) for a [video introduction!](#)

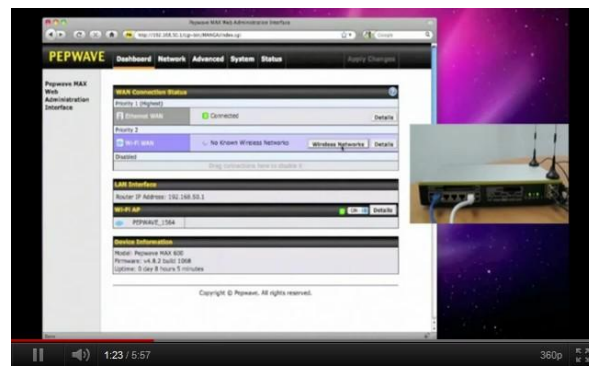

<http://youtu.be/UckVQThLKO4>

User Manual

PEPWAVE *MAX* mobile router

2 Glossary

The following terms, acronyms, and abbreviations are frequently used in this manual:

Term	Definition
3G	3rd Generation standards for wireless communications (e.g. HSDPA)
4G	4th Generation standards for wireless communications (e.g. WiMAX, LTE)
DHCP	Dynamic Host Configuration Protocol
DNS	Domain Name System
EVDO	Evolution-Data Optimized
HSDPA	High-Speed Downlink Packet Access
HTTP	Hyper-Text Transfer Protocol
ICMP	Internet Control Message Protocol
IP	Internet Protocol
LAN	Local Area Network
MAC Address	Media Access Control Address
MTU	Maximum Transmission Unit
MSS	Maximum Segment Size
NAT	Network Address Translation
PPPoE	Point to Point Protocol over Ethernet
QoS	Quality of Service
SNMP	Simple Network Management Protocol
TCP	Transmission Control Protocol
UDP	User Datagram Protocol
VPN	Virtual Private Network
VRRP	Virtual Router Redundancy Protocol
WAN	Wide Area Network
WINS	Windows Internet Name Service
WLAN	Wireless Local Area Network

3 Product Features

Pepwave MAX enables all LAN users to share broadband Internet connections, and provide advanced features to enhance Internet access. The following is the list of supported features on Pepwave MAX Mobile Router:

3.1 Supported Network Features

3.1.1 WAN

- Ethernet WAN Connection in Full/Half Duplex
- Built-in HSPA and EVDO cellular modems (**Available on Pepwave MAX HD2**)
- USB mobile connection(s)
- PC Card WAN connection (**Available on Pepwave MAX 600**)
- ExpressCard WAN connection (**Available on Pepwave MAX 600**)
- Wi-Fi WAN connection
- Network Address Translation (NAT)/ Port Address Translation (PAT)
- Inbound and Outbound NAT mapping
- IPsec NAT-T and PPTP packet passthrough
- MAC address clone and passthrough
- Customizable MTU and MSS values
- WAN connection health check
- Dynamic DNS (Supported service providers: changeip.com, dyndns.org, no-ip.org, tzo.com and DNS-O-Matic)
- Ping, DNS Lookup and HTTP based health check

3.1.2 LAN

- Wi-Fi AP
- Ethernet LAN ports
- DHCP server on LAN
- Static routing rules

3.1.3 VPN

- SpeedFusion™
- VPN load balancing and failover among selected WAN connections
- Bandwidth bonding & failover among selected WAN connections
- IPsec VPN for Network-to-Network connection (Works with Cisco, Juniper only)
- Ability to route Internet traffic to a remote VPN peer
- Optional pre-shared key setting
- SpeedFusion™ Throughput, Ping and Traceroute Test
- PPTP server
- PPTP and IPsec passthrough

3.1.4 Firewall

- Outbound (LAN to WAN) firewall rules
- Inbound (WAN to LAN) firewall rules per WAN connection

User Manual

PEPWAVE *MAX* mobile router

- Intrusion detection and prevention
- Specification of NAT mappings
- Outbound firewall rules can be defined by destination domain name

3.1.5 Outbound Policy

- Link load distribution per TCP/UDP service
- Persistent routing for specified source and/or destination IP addresses per TCP/UDP service
- Traffic Prioritization and DSL optimization
- Prioritize and route traffic to VPN tunnels with Priority and Enforced algorithms

3.1.6 QoS

- Quality of Service for different applications and custom protocols
- User Group classification for different service levels
- Bandwidth usage control and monitoring on group- and user- level
- Application Prioritization for custom protocols and DSL/Cable optimization

3.2 Other Supported Features

- User-friendly web-based administration interface
- HTTP and HTTPS support for Web Admin Interface
- Configurable web administration port and administrator password
- Firmware upgrades, configuration backups, Ping, and Traceroute via Web Admin Interface
- Remote web based configuration (via WAN and LAN interfaces)
- Time server synchronization
- SNMP
- Email notification
- Read-only user for Web Admin
- Authentication and Accounting by RADIUS server for Web Admin
- Built-in WINS Servers
- Syslog
- SIP passthrough
- PPTP packet passthrough
- Event Log
- Active Sessions
- Client List
- WINS Client List
- UPnP / NAT-PMP
- Real-Time, Hourly, Daily and Monthly Bandwidth Usage reports and charts
- IPv6 support (**Available on Pepwave MAX 700 and HD2**)
- Support USB tethering on Android 2.2+ phones

User Manual

PEPWAVE *MAX* mobile router

4 Pepwave MAX Mobile Router Overview

4.1 MAX 600

4.1.1 Front Panel Appearance

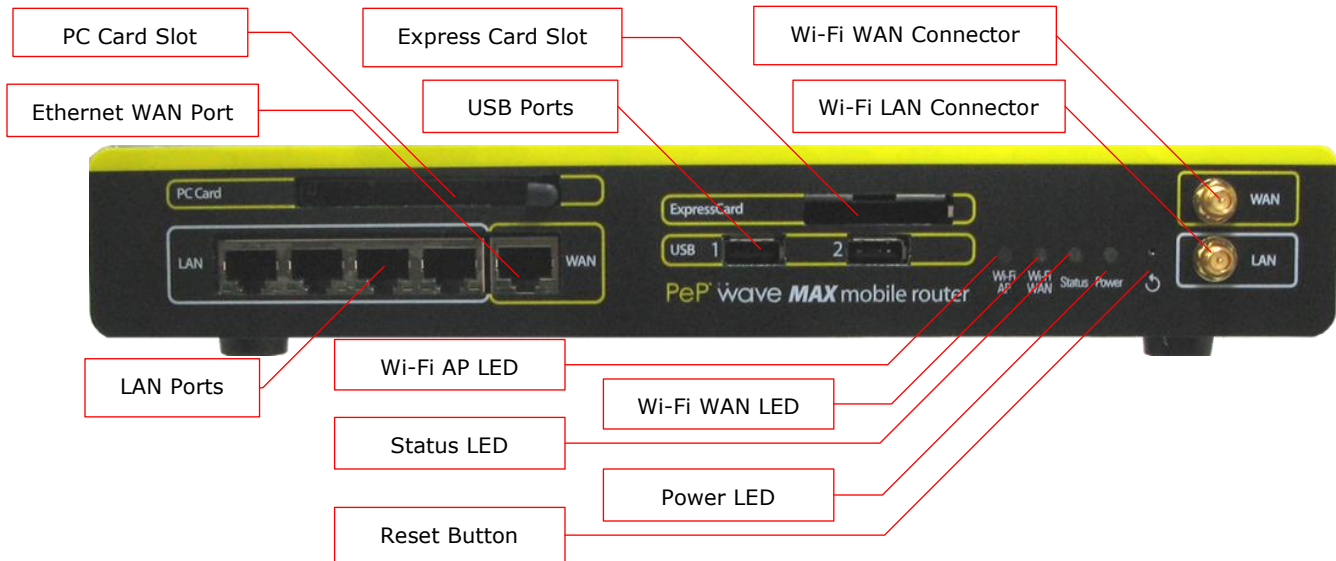

4.1.2 LED Indicators

The statuses indicated by the Front Panel LEDs are as follows:

Power and Status Indicators		
Power	OFF	Power off
	Green	Power on
Status	OFF	System initializing
	Red	Booting up or busy
	Green	Ready state

Wi-Fi AP and Wi-Fi WAN Indicators		
Wi-Fi WAN	OFF	Disabled Intermittent
	Blinking	Trying to connect but not connected to any wireless network
	ON	Connected to wireless network(s) without traffic
	Continuous Blinking	Transferring data
Wi-Fi AP	OFF	Disabled Intermittent
	Blinking	Enabled but no client connected
	ON	Client(s) connected to wireless network
	Continuous Blinking	Transferring data to wireless network

User Manual

PEPWAVE *MAX* mobile router

LAN and Ethernet WAN Ports		
Green LED	ON	100 Mbps
	OFF	10 Mbps
Orange LED	Solid	Port is connected without traffic
	Blinking	Data is transferring
	OFF	Port is not connected
Port Type	Auto MDI/MDI-X ports	

4.1.3 Rear Panel Appearance

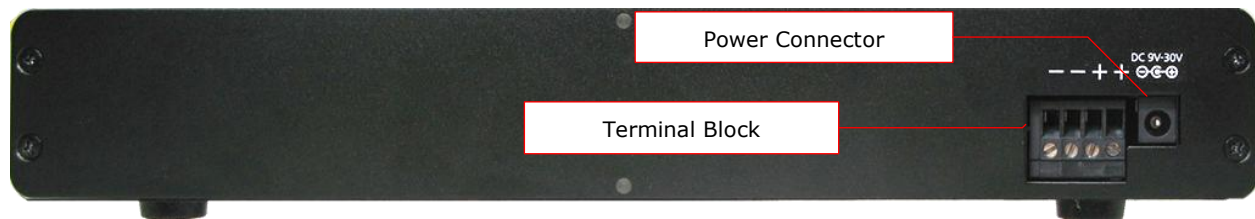

User Manual

PEPWAVE *MAX* mobile router

4.2 MAX 700

4.2.1 Front Panel Appearance

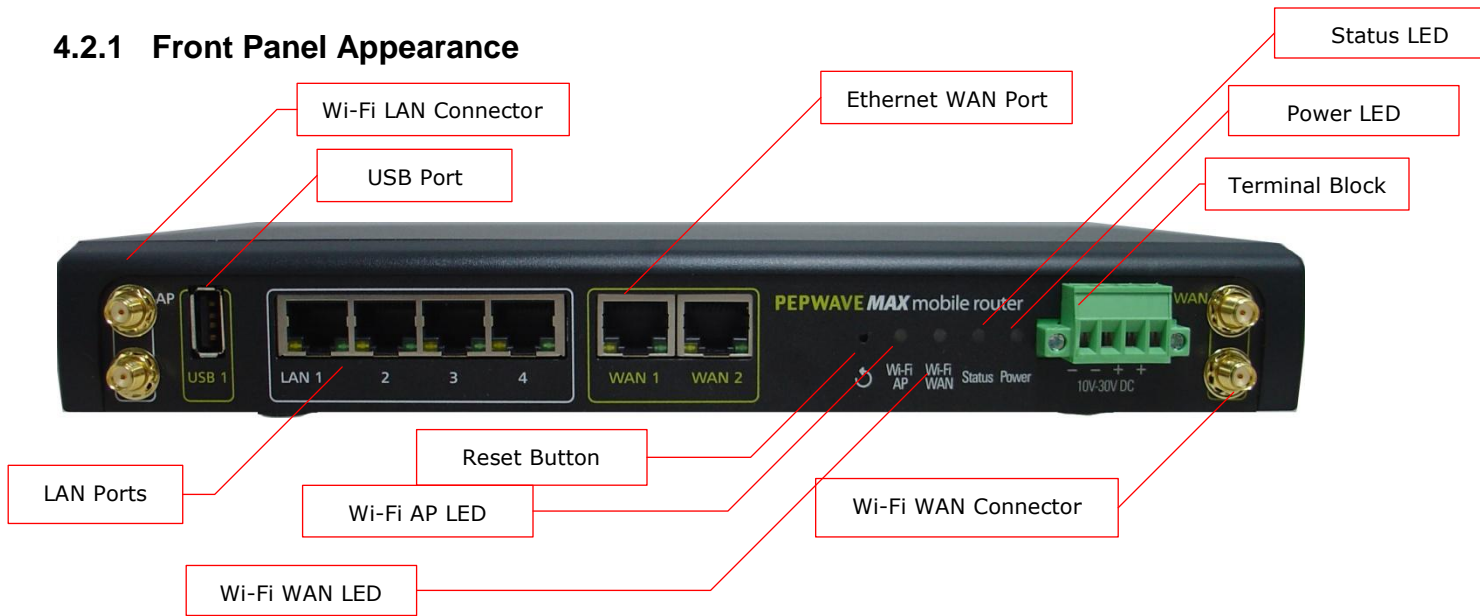

4.2.2 LED Indicators

The statuses indicated by the Front Panel LEDs are as follows:

Status Indicators		
Status	OFF	System initializing
	Red	Booting up or busy
	Blinking red	Boot up error
	Green	Ready

Wi-Fi AP and Wi-Fi WAN Indicators		
Wi-Fi WAN	OFF	Disconnected
	Blinking slowly	Connecting to network
	Blinking	Connected to network with traffic
	ON	Connected to network without traffic
Wi-Fi AP	OFF	Disabled
	Blinking slowly	Enabled but no client connected
	Blinking	Connected to network with traffic
	ON	Client(s) connected to wireless network

User Manual

PEPWAVE *MAX* mobile router

LAN and Ethernet WAN Ports		
Green LED	ON	10 / 100/ 1000 Mbps
Orange LED	Blinking	Data is transferring
	OFF	No data is being transferred or port is not connected
Port Type	Auto MDI/MDI-X ports	

4.2.3 Rear Panel Appearance

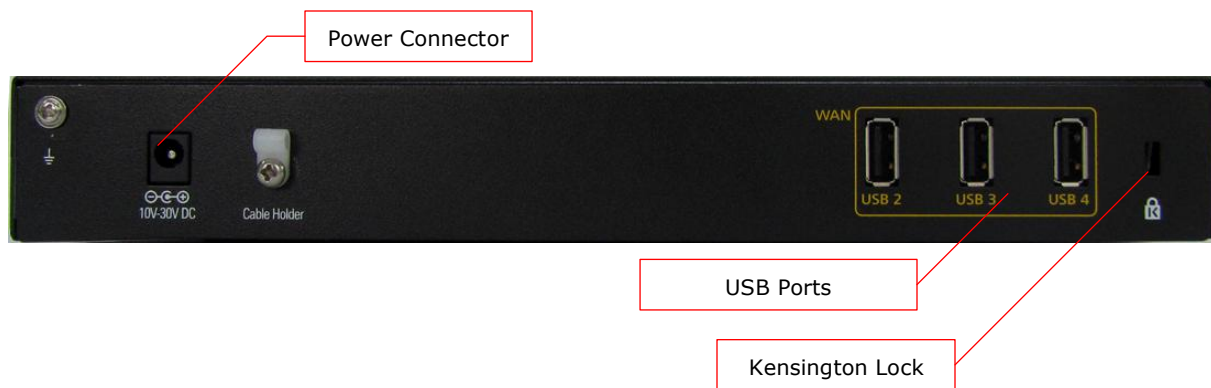

User Manual

PEPWAVE *MAX* mobile router

4.3 MAX HD2

4.3.1 Front Panel Appearance

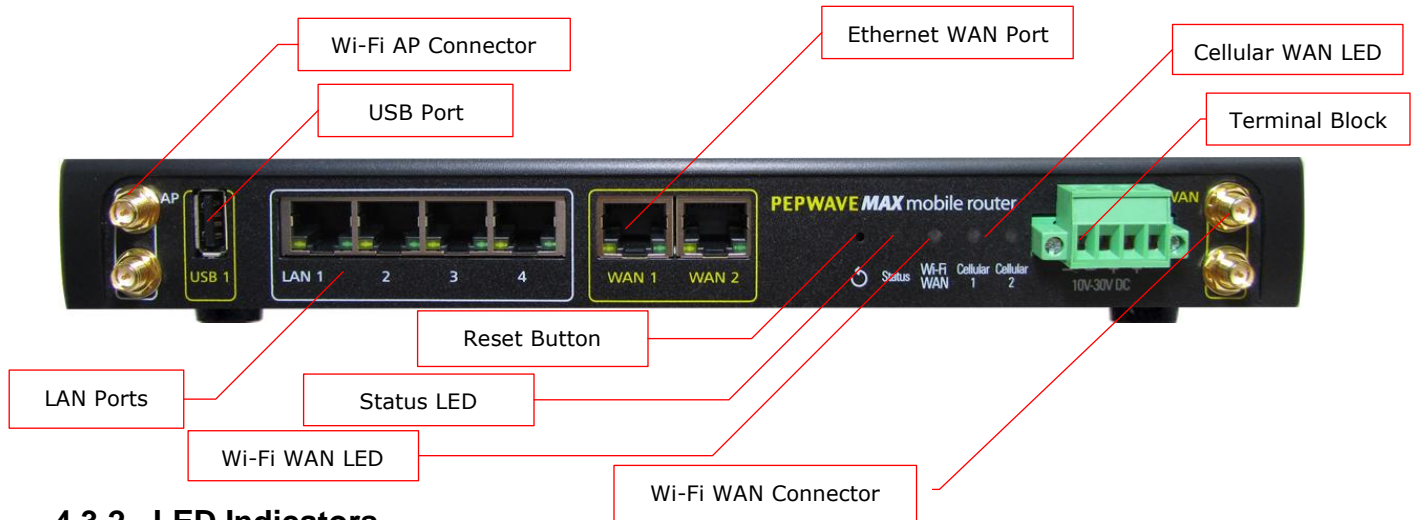

4.3.2 LED Indicators

The statuses indicated by the Front Panel LEDs are as follows:

Status Indicators		
Status	OFF	System initializing
	Red	Booting up or busy
	Blinking red	Boot up error
	Green	Ready

Wi-Fi AP and Wi-Fi WAN Indicators		
Wi-Fi WAN / Cellular 1 / Cellular 2	OFF	Disabled Intermittent
	Blinking slowly	Connecting to wireless network(s)
	Blinking	Connected to wireless network(s) with traffic
	ON	Connected to wireless network(s) without traffic

LAN and Ethernet WAN Ports		
Green LED	ON	10 / 100 / 1000 Mbps
	Blinking	Data is transferring
Orange LED	OFF	No data is being transferred or port is not connected
	Port Type	Auto MDI/MDI-X ports

User Manual

PEPWAVE *MAX* mobile router

4.3.3 Rear Panel Appearance



User Manual

PEPWAVE *MAX* mobile router

5 Installation

Connecting the Network with Pepwave MAX Mobile Router:

5.1 Preparation

Before installing Pepwave MAX Mobile Router, please prepare the following:

- At least one Internet/WAN access account and/or Wi-Fi access information.
- For each network connection,
 - **Ethernet WAN:** A 10/100/1000 BaseT UTP cable with RJ45 connector
 - **USB:** A USB modem
 - **Embedded Modem:** A SIM card for GSM/HSPA service
 - **Wi-Fi WAN:** Wi-Fi antennas
 - **PC Card / Express Card WAN:** A PC Card/Express Card for the corresponding card slot.
- A computer with TCP/IP network protocol and a web browser installed. Supported browsers include Microsoft Internet Explorer 8.0 or above, Mozilla Firefox 10.0 or above, Apple Safari 5.1 or above, and Google Chrome 18 or above.

5.2 Constructing the Network

At the high level, construct the network according to the following steps:

1. With an Ethernet cable, connect a computer to one of the LAN ports on the Pepwave MAX. Repeat with different cables for up to 4 computers to be connected.
2. With another Ethernet cable or a USB modem / Wi-Fi antenna / PC Card / Express Card, connect it to one of the WAN ports on the Pepwave MAX. Repeat the same procedure for other WAN ports.
3. Connect the power adapter to the power connector on the rear panel of Pepwave MAX, and then plug it into a power outlet.

The following figure schematically illustrates the configuration that results:

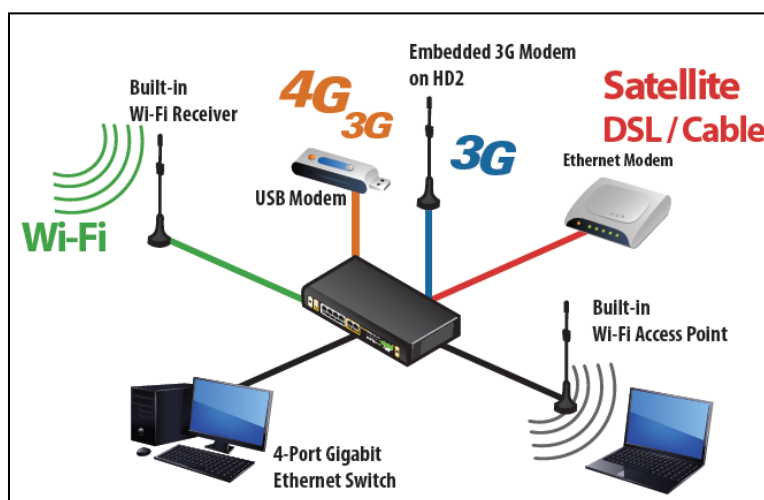

User Manual

PEPWAVE *MAX* mobile router

5.3 Configuring the Network Environment

To ensure that Pepwave MAX works properly in the LAN environment and can access the Internet via the WAN connections, please refer to the following setup procedures:

- LAN Configuration
For basic configuration, refer to Section 6, Connecting to Web Admin Interface.
For advanced configuration, go to Section 7, Configuration of LAN Interface(s).
- WAN Configuration
For basic configuration, refer to Section 6, Connecting to Web Admin Interface.
For advanced configuration, go to Section 8, Configuration of WAN Interface(s).

5.4 Mounting the Unit

5.4.1 Wall Mount

Pepwave MAX can be mounted on the wall by screwing. After adding the screw on the wall, slide the MAX in the screw whole socket as indicated below.

Recommended Screw Specification: M3.5 x 20mm, Head Diameter 6mm, Head Thickness 2.4mm

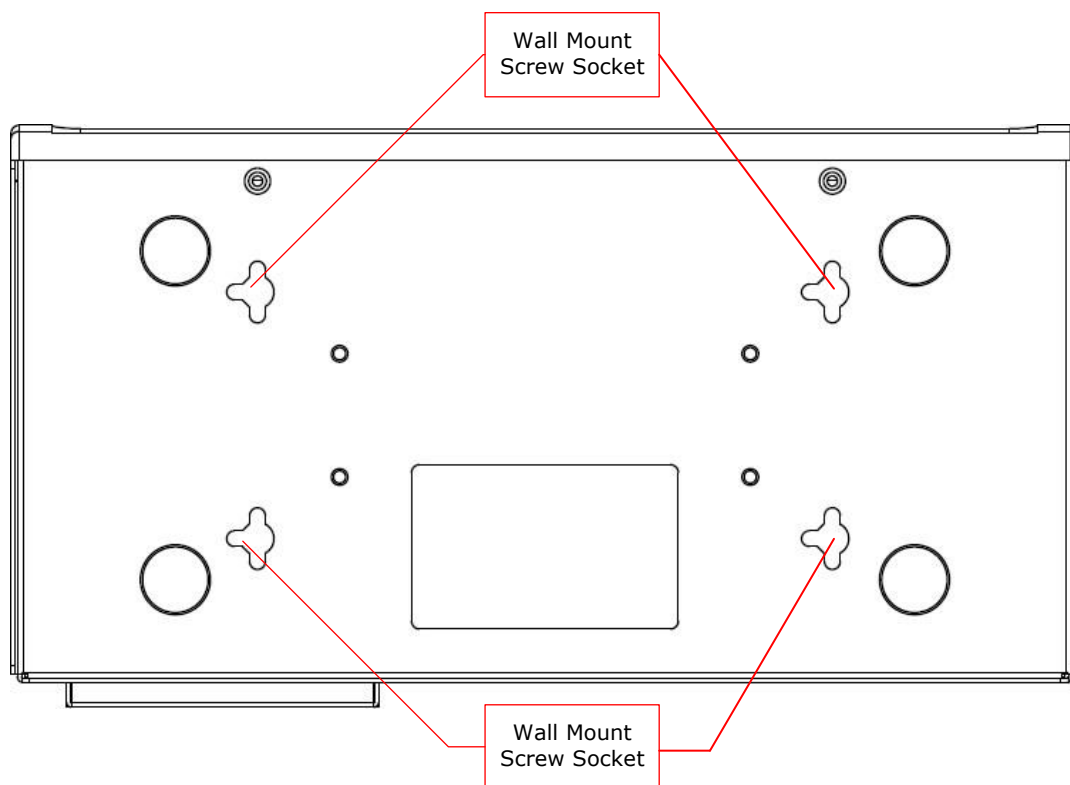

User Manual

PEPWAVE *MAX* mobile router

5.4.2 Car Mount

Pepwave MAX can be mounted on a flat surface using a car mounting plate (not included). Place the car mount according to the label's direction, and screw it onto the device.

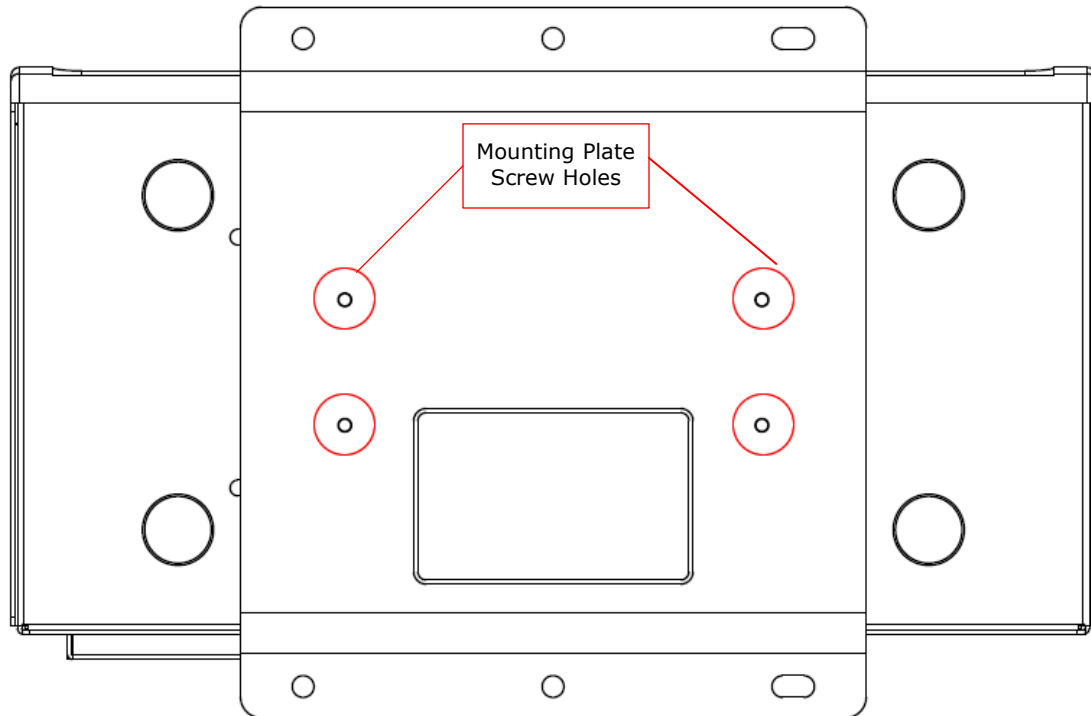

After mounting the plate on the back of the device, add screw on the plate on the flat surface.

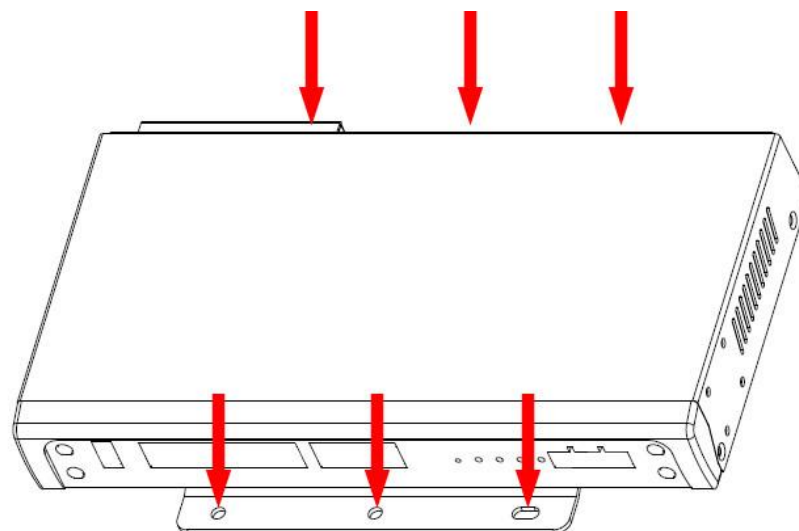

6 Connecting to Web Admin Interface

1. Start a web browser on a computer that is connected with Pepwave MAX through LAN.
2. To connect to Web Admin Interface of Pepwave MAX, enter the following LAN IP address in the address field of the web browser:

http://192.168.50.1

(This is the default LAN IP address of Pepwave MAX.)

3. Enter the following to access the Web Admin Interface.

Username: admin

Password: admin

(This is the default Username and Password of Pepwave MAX. The Admin and Read-only User Password can be changed at **System > Admin Security** of the Web Admin Interface.)

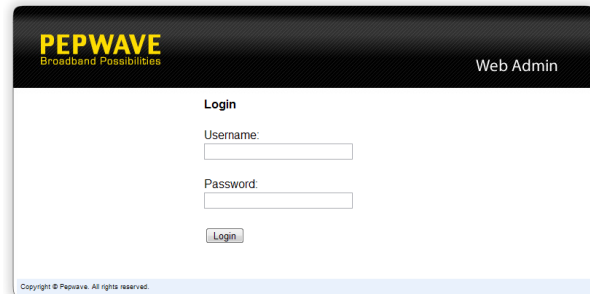

User Manual

PEPWAVE *MAX* mobile router

4. After successful login, the **Dashboard** of Web Admin Interface will be displayed. It looks similar to the following:

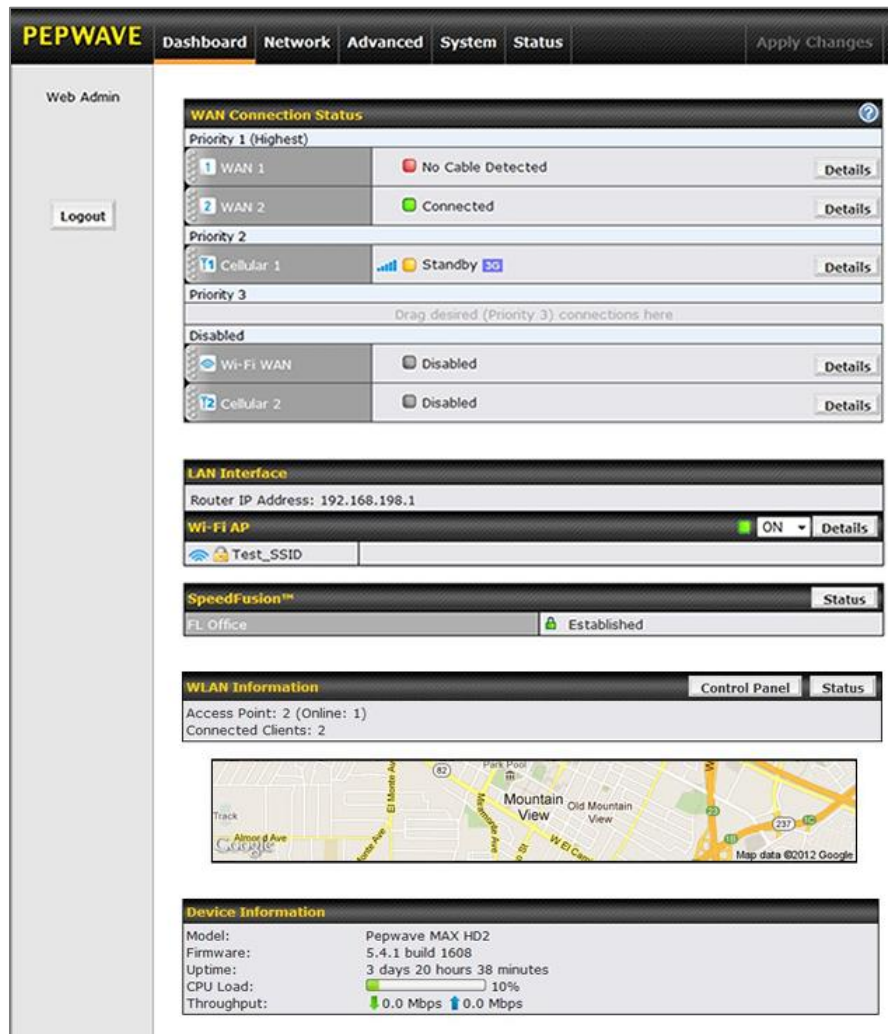

Dashboard shows the current WAN, LAN, Wi-Fi AP settings and statuses. You can simply change priority of WAN connections and switch on / off Wi-Fi AP in here. For further information about how-to set up these connections, please refer to Section 7.2 and 8.

A map with real-time GPS data is shown on the **Dashboard** when GPS signal is received. (HD2 only)

Device Information shows the details about the device, including Model name, Firmware version and Uptime. For further information please refer to Section 19.

Important Note

Configuration changes (e.g. WAN, LAN, Admin settings, etc.) will only take effect after clicking the **Save** button at the bottom of each page. The **Apply Changes** button causes the changes to be saved and applied.

User Manual

PEPWAVE *MAX* mobile router

7 Configuration of LAN Interface(s)

7.1 Basic Settings

The LAN Interface settings are located in **Network > LAN > Basic Settings**

IP Settings									
IP Address *	<input type="text" value="192.168.50.1"/>								
Subnet Mask *	<input type="text" value="255.255.255.0 (/24)"/>								
Speed	<input type="text" value="Auto"/>								
Drop-In Mode Settings									
Enable	<input type="checkbox"/>								
DHCP Server Settings									
DHCP Server	<input type="checkbox"/> Enable								
IP Range	<input type="text" value="192.168.50.10"/> - <input type="text" value="192.168.50.200"/>								
Subnet Mask	<input type="text" value="255.255.255.0 (/24)"/>								
Lease Time	<input type="text" value="1"/> Days <input type="text" value="0"/> Hours <input type="text" value="0"/> Mins <input type="text" value="0"/> Seconds								
DNS Servers	<input checked="" type="checkbox"/> Assign DNS server automatically								
WINS Servers	<input type="checkbox"/> Assign WINS server								
Extended DHCP Option	<table border="1"> <thead> <tr> <th>Option</th> <th>Value</th> </tr> </thead> <tbody> <tr> <td colspan="2" style="text-align: center;">No Extended DHCP Option</td> </tr> <tr> <td colspan="2" style="text-align: center;"><input type="button" value="Add"/></td> </tr> </tbody> </table>			Option	Value	No Extended DHCP Option		<input type="button" value="Add"/>	
Option	Value								
No Extended DHCP Option									
<input type="button" value="Add"/>									
DHCP Reservation	<table border="1"> <thead> <tr> <th>Name</th> <th>MAC Address</th> <th>Static IP</th> </tr> </thead> <tbody> <tr> <td> </td> <td> </td> <td> </td> </tr> </tbody> </table>			Name	MAC Address	Static IP			
Name	MAC Address	Static IP							
Static Route Settings									
Static Route	<table border="1"> <thead> <tr> <th>Destination Network</th> <th>Subnet Mask</th> <th>Gateway</th> </tr> </thead> <tbody> <tr> <td> </td> <td> </td> <td> </td> </tr> </tbody> </table>			Destination Network	Subnet Mask	Gateway			
Destination Network	Subnet Mask	Gateway							
WINS Server Settings									
Enable	<input type="checkbox"/>								
DNS Proxy Settings									
Enable	<input checked="" type="checkbox"/>								
DNS Caching	<input type="checkbox"/>								
Use Google DNS Server as Backup	<input type="checkbox"/>								
Local DNS Records	<table border="1"> <thead> <tr> <th>Host Name</th> <th>IP Address</th> </tr> </thead> <tbody> <tr> <td> </td> <td> </td> </tr> </tbody> </table>			Host Name	IP Address				
Host Name	IP Address								
* Required									
<input type="button" value="Save"/>									



User Manual

PEPWAVE *MAX* mobile router

IP Settings

IP Address & Subnet Mask	The IP address of Pepwave MAX on LAN.
Speed	<p>This setting specifies the speed of the LAN Ethernet Port.</p> <p>By default, Auto is selected and the appropriate data speed is automatically detected by Pepwave MAX.</p> <p>In the event of negotiation issues, the port speed can be manually specified to circumvent the issues. You can also choose whether or not to advertise the speed to the peer by selecting the Advertise Speed checkbox.</p>

DHCP Server Settings

DHCP Server	<p>When this setting is enabled, the DHCP server of Pepwave MAX automatically assigns an IP address to each computer that is connected via LAN and is configured to obtain an IP address via DHCP.</p> <p>Pepwave MAX's DHCP server can prevent IP address collision on LAN.</p>
IP Range & Subnet Mask	This setting allocates a range of IP address that will be assigned to LAN computers by the DHCP server of Pepwave MAX.
Lease Time	This setting specifies the length of time throughout which an IP address of a DHCP client remains valid. Upon expiration of the Lease Time, the assigned IP address will no longer be valid and the renewal of the IP address assignment will be required.
DNS Servers	This option allows you to input the DNS server addresses to be offered to the DHCP clients. If Assign DNS server automatically is selected, the Pepwave MAX's built-in DNS server address (i.e. LAN IP address) will be offered.
WINS Server	<p>This option allows you to specify the Windows Internet Name Service (WINS) server. You may choose to use the built-in WINS server or external WINS servers.</p> <p>When this unit is SpeedFusion™ connected, other VPN peers can share this unit's built-in WINS server by entering this unit's LAN IP address in their DHCP WINS Servers setting. Therefore, all PC clients in the VPN can resolve the NetBIOS names of other clients in remote peers.</p> <p>If you have enabled this option, a list of WINS clients will be displayed at Status > WINS Clients.</p>
Extended DHCP Option	<p>In addition to standard DHCP options (e.g. DNS server address, gateway address, subnet mask), you can specify the value of additional Extended DHCP Options defined in RFC 2132. In this case, you can pass additional configuration information to LAN hosts.</p> <p>To define an Extended DHCP Option, click the Add button, choose the option that you want to define and enter its value. For values that are in IP address list format, you can enter one IP address per line in the provided text area input control. Each option is allowed to be defined once only.</p>
DHCP Reservation	<p>This setting reserves the assignment of fixed IP addresses for a list of computers on the LAN. The computers to be assigned fixed IP addresses on the LAN are identified by their MAC addresses.</p> <p>The fixed IP address assignment is displayed as a cross-reference list between the computers' Name, MAC addresses and fixed IP addresses.</p> <p>The field Name (an optional field) is for you to define a name to represent the device. MAC addresses should be in the format of 00:AA:BB:CC:DD:EE</p> <p>Press  to create a new record. Press  to remove a record</p>

User Manual

PEPWAVE *MAX* mobile router



Reserved clients information can be imported from the Client List, located at **Status > Client List**. For more details, please refer to section 19.3.

Static Route Settings

Static Route

This table is for defining static routing rules for the LAN segment. A static route consists of the network address, subnet mask, and gateway address. The address and subnet mask values are in the format of w.x.y.z

The local LAN subnet and subnets behind the LAN will be advertised to the VPN. Remote routes sent over the VPN will also be accepted. Any VPN member will be able to route to the local subnets.

Press  to create a new route. Press  to remove a route.

WINS Server Settings

Enable

Check the box to enable the WINS Server. A list of WINS clients will be displayed at **Status > WINS Clients**.

DNS Proxy Settings

Enable

A check box to enable to DNS Proxy feature.

Network > LAN > DNS Proxy Settings table

A DNS proxy server can be enabled to serve DNS requests originating from LAN/PPTP/SpeedFusion™ peers. Requests are forwarded to the **DNS servers/resolvers** defined in each WAN connection

DNS Caching

This field is to enable DNS caching on the built-in DNS proxy server. When the option is enabled, queried DNS replies will be cached until the records' TTL has been reached. This feature can help improve the DNS lookup time. However, it cannot return the most updated result for those frequently updated DNS records.

By default, it is **disabled**.

Include Google Public DNS Servers

When this option is **enabled**, the DNS proxy server will also forward DNS requests to [Google's Public DNS Servers](#) in addition to the DNS servers defined in each WAN. This could increase the DNS service's availability.

Default: **disabled**

Local DNS Records

This table is for defining custom local DNS records.

A static local DNS record consists of a Host Name and an IP Address. When looking up the Host Name from the LAN to LAN IP of Pepwave MAX, the corresponding IP Address will be returned.

Press  to create a new record. Press  to remove a record.

LAN DNS Resolver Settings

Enable

Check the box to enable the WINS Server. A list of WINS clients will be displayed at **Network > LAN > DNS Proxy Settings > DNS Resolvers**.

This field specifies which DNS resolvers will receive forwarded DNS requests. If no WAN/VPN/LAN DNS resolver is selected, all of the WAN's DNS resolvers will be selected.

User Manual

PEPWAVE *MAX* mobile router

If a SpeedFusion™ peer is selected, you may enter the VPN peer's DNS resolver IP address(es).

Queries will be forwarded to the selected connections' resolvers. If all of the selected connections are down, queries will be forwarded to all resolvers on healthy WAN connections.

User Manual

PEPWAVE *MAX* mobile router

7.2 Wi-Fi AP

The Wi-Fi LAN settings can be configured in **Network > LAN > Wi-Fi AP**:

Wi-Fi AP can also be switched on / off on the Dashboard.



Click **Add** button to create a new SSID.

Wireless Network Settings	
Network Name (SSID)	<input type="text"/>
Enable	<input checked="" type="radio"/> Yes <input type="radio"/> No
Broadcast SSID	<input checked="" type="checkbox"/> Enable
Multicast Filter	<input type="checkbox"/> Enable
Multicast Rate	MCS0
Multicast Enhancement	<input checked="" type="checkbox"/>
Wireless Security Settings	
Security Policy	Open (No Encryption)
Access Control Settings	
Restriction Mode	None
<input type="button" value="Save"/>	

Wireless Network Settings	
Network Name (SSID)	This setting allows you to specify a name to represent the virtual AP to be scanned by Wi-Fi clients.
Enable	When Yes is selected, this virtual AP is enabled. Select No to disable it. By default, it is enabled. You can also choose to enable or disable this virtual AP on the Dashboard - Connection Status of Wi-Fi AP, please refer to section 6 for information.
Broadcast SSID	When the box Enable is checked, this SSID can be scanned by Wi-Fi clients. By default, it is enabled .
Multicast Filter	When the box Enable is checked, multicast network traffic to the wireless SSID will be filtered. By default, it is disabled .
Multicast Rate	This field allows you to specify the transmit rate to be used for sending multicast network traffic. By default, Multicast Rate is set to 1M .

User Manual

PEPWAVE *MAX* mobile router

Wireless Security Settings

This setting specifies which security policy will be used for this wireless network.
Available options:

- Open (No Encryption)

Wireless Security Settings	
Security Policy	Open (No Encryption) ▼

- WPA/WPA2 – Personal

Wireless Security Settings	
Security Policy	WPA/WPA2 - Personal ▼
Encryption	TKIP/AES:CCMP
Shared Key	<input type="text"/> <input checked="" type="checkbox"/> Hide Characters

- WPA/WPA2 – Enterprise

Wireless Security Settings	
Security Policy	WPA/WPA2 - Enterprise ▼
Encryption	TKIP/AES:CCMP

RADIUS Server Settings	Primary Server	Secondary Server
Host	<input type="text"/>	<input type="text"/>
Secret	<input type="text"/>	<input type="text"/>
Authentication Port	1812 <input type="button" value="Default"/>	1812 <input type="button" value="Default"/>
Accounting Port	1813 <input type="button" value="Default"/>	1813 <input type="button" value="Default"/>

- 802.1X

Wireless Security Settings	
Security Policy	802.1X ▼
WEP Key Size	40 bits (64-bit WEP) ▼
Re-keying Period	0 <input type="text"/> seconds (0: Disable)

RADIUS Server Settings	Primary Server	Secondary Server
Host	<input type="text"/>	<input type="text"/>
Secret	<input type="text"/>	<input type="text"/>
Authentication Port	1812 <input type="button" value="Default"/>	1812 <input type="button" value="Default"/>
Accounting Port	1813 <input type="button" value="Default"/>	1813 <input type="button" value="Default"/>

- Static WEP

Wireless Security Settings	
Security Policy	Static WEP ▼
Key Size	40 bits (64-bit WEP) ▼
Key Format	ASCII ▼
Encryption Key	<input type="text"/>
Shared Key Authentication	<input type="checkbox"/> Enable

Security Policy

Access Control Settings

Restriction Mode

Access Control Settings	
Restriction Mode	Accept all except listed ▼
MAC Address List	<input type="text"/> <input type="text"/> <input type="text"/>

This option allows you to perform access control through MAC address filtering.
Available options are **None**, **Deny all except listed**, and **Accept all except listed**.

8 Configuration of WAN Interface(s)

The WAN Interface settings are located at: **Network > WAN**

To reorder different WANs' priority, just drag on the appropriate WAN by holding the left mouse button, move it to the desired priority (the first one would be the highest priority, the second one would be lower priority and so on) and drop it by releasing the mouse button.

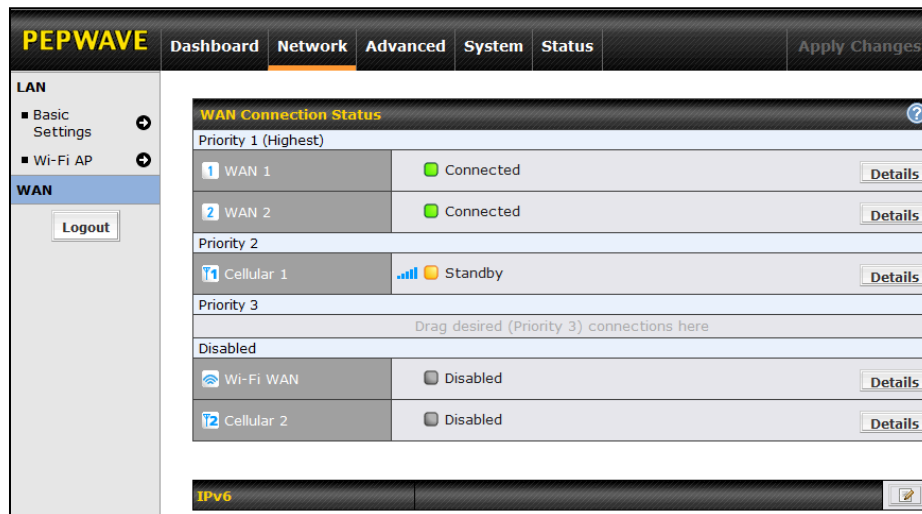

To disable a particular WAN connection, just drag on the appropriate WAN by holding the left mouse button, move it to the **Disabled** row and drop it by releasing the mouse button.

You can also do the above priority setting on the **Dashboard**, please refer to Section 6 for information.

Click the **Details** button in the corresponding row of connection to modify the connection setting.

Important Note

Connection Details will be changed and become effective right after clicking the **Save and Apply** button.

User Manual

PEPWAVE *MAX* mobile router

8.1 Ethernet WAN

Network > WAN > Click on WAN Details

Details

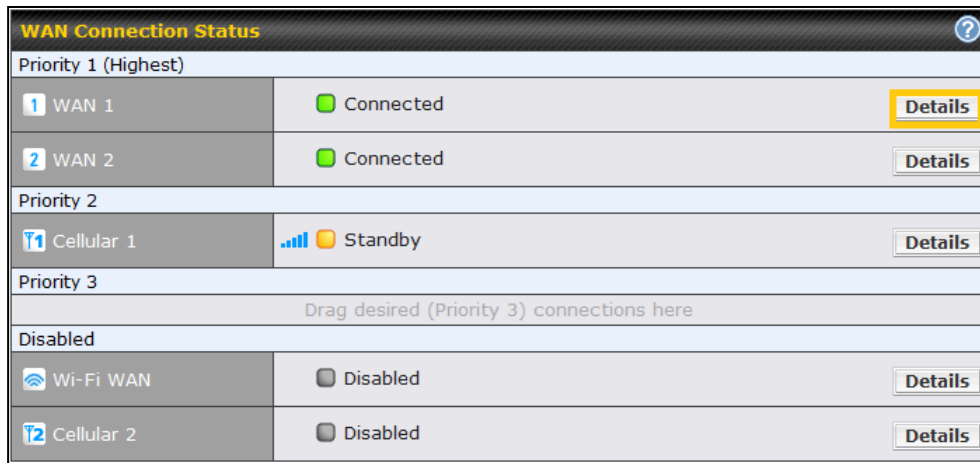

The screenshot shows the 'WAN Connection Status' interface. It is organized into sections based on priority. Priority 1 (Highest) contains two entries: 'WAN 1' and 'WAN 2', both with a green 'Connected' status and a 'Details' button. Priority 2 contains 'Cellular 1' with a 'Standby' status and a 'Details' button. Priority 3 is currently empty, with a prompt to 'Drag desired (Priority 3) connections here'. A 'Disabled' section contains 'Wi-Fi WAN' and 'Cellular 2', both with a grey 'Disabled' status and a 'Details' button.

WAN Connection Status		
Priority 1 (Highest)		
1 WAN 1	Connected	Details
2 WAN 2	Connected	Details
Priority 2		
1 Cellular 1	Standby	Details
Priority 3		
Drag desired (Priority 3) connections here		
Disabled		
Wi-Fi WAN	Disabled	Details
2 Cellular 2	Disabled	Details

This will open a screen similar to shown below

User Manual

PEPWAVE *MAX* mobile router

Connection Details ✕

WAN Port	
WAN Connection Name	WAN 1 Default
Connection Method ?	Static IP ▼
Routing Mode ?	<input checked="" type="radio"/> NAT
IP Address	172.11.22.10
Subnet Mask	255.255.255.0 (/24) ▼
Default Gateway	172.11.22.2
DNS Servers	<input checked="" type="checkbox"/> Use the following DNS server address(es) DNS Server 1: <input type="text"/> DNS Server 2: <input type="text"/>
Standby State ?	<input checked="" type="radio"/> Remain connected <input type="radio"/> Disconnect
Upstream Bandwidth ?	1000 Mbps ▼
Downstream Bandwidth ?	1000 Mbps ▼
Health Check Method ?	Disabled ▼ Health Check disabled. Network problem cannot be detected.
Dynamic DNS ?	Disabled ▼
Bandwidth Allowance Monitor ?	<input type="checkbox"/> Enable
Port Speed ?	Auto ▼
MTU ?	<input type="radio"/> Auto <input checked="" type="radio"/> Custom Value: 1440 Default
MSS ?	<input checked="" type="radio"/> Auto <input type="radio"/> Custom Value: <input type="text"/>
MAC Address Clone ?	00 : 1A : DD : BD : 1E : 41 Default
VLAN	<input type="checkbox"/>
Reply to ICMP PING ?	<input checked="" type="radio"/> Yes <input type="radio"/> No
Additional Public IP Address	<div style="border: 1px solid #ccc; padding: 5px; margin-bottom: 5px;"><div style="display: flex; justify-content: space-between;">IP Address<input type="text"/></div><div style="display: flex; justify-content: space-between;">Subnet Mask<input type="text" value="255.255.255.0 (/24)"/></div></div> <div style="text-align: center; margin: 5px 0;"><input type="button" value="↓"/></div> <div style="border: 1px solid #ccc; height: 40px; width: 100%;"></div> <div style="text-align: right; margin-top: 5px;"><input type="button" value="Delete"/></div>

User Manual

PEPWAVE *MAX* mobile router

Ethernet WAN Settings

WAN Connection Name	This field is for defining a name to represent this WAN connection.
Connection Method	<p>There are three possible connection methods for Ethernet WAN:</p> <ul style="list-style-type: none">• DHCP• Static IP• PPPoE <p>The connection method and details are determined by, and can be obtained from, the ISP. See the Sections 8.1.1, 8.1.2, and 8.1.3 for details of each connection method.</p>
Standby State	<p>This setting specifies the state of the WAN connection. The available options are Remain connected and Disconnect.</p> <p>The default state is Remain Connected.</p>
Upstream Bandwidth	This setting specifies the data bandwidth in the outbound direction from the LAN through the WAN interface.
Downstream Bandwidth	<p>This setting specifies the data bandwidth in the inbound direction from the WAN interface to the LAN.</p> <p>This value is referenced as the default weight value when using the algorithm Least Used, or the algorithm Persistence (Auto) in Outbound Policy with Managed by Custom Rules chosen (see Section 12.2).</p>
Health Check Method	<p>This setting specifies the health check method for the WAN connection. The value of method can be configured as Disabled, Ping or DNS Lookup.</p> <p>The default method is Disabled.</p> <p>See Section 8.4 for configuration details.</p>
Dynamic DNS	<p>This setting specifies the dynamic DNS service provider to be used for the WAN based on supported dynamic DNS service providers:</p> <ul style="list-style-type: none">• changeip.com• dyndns.org• no-ip.org• tzo.com• DNS-O-Matic <p>Select Disabled to disable this feature.</p> <p>See Section 8.1.4 for configuration details.</p>
Bandwidth Allowance Monitor	<p>This option allows you to enable bandwidth usage monitoring on this WAN connection for each billing cycle. When this is not enabled, bandwidth usage of each month is still being tracked but no action will be taken.</p> <p>See Section 8.5 for configuration details.</p>
Port Speed	<p>This setting specifies port speed and duplex configurations of the WAN Port.</p> <p>By default, Auto is selected and the appropriate data speed is automatically detected by</p>

User Manual

PEPWAVE *MAX* mobile router

	<p>Pepwave MAX.</p> <p>In the event of negotiation issues, the port speed can be manually specified to circumvent the issues. You can also choose whether or not to advertise the speed to the peer by selecting the Advertise Speed checkbox.</p>
MTU	<p>This setting specifies the Maximum Transmission Unit.</p> <p>By default, MTU is set to Custom 1440.</p> <p>You may adjust the MTU value by editing the text field. Click Default to restore the default MTU value. Select Auto and the appropriate MTU value will be automatically detected. The auto-detection will run each time when the WAN connection establishes.</p>
MSS	<p>This setting should be configured based on the maximum payload size that the local system can handle. The MSS (Maximum Segment Size) is computed from the MTU minus 40 bytes for TCP over IPv4.</p> <p>If MTU is set to Auto, the MSS will also be set automatically.</p> <p>By default, MSS is set to Auto.</p>
MAC Address Clone	<p>This setting allows you to configure the MAC address.</p> <p>Some service providers (e.g. cable providers) identify the client's MAC address and require the client to always use the same MAC address to connect to the network. In such cases, change the WAN interface's MAC address to the original client PC's one via this field.</p> <p>The default MAC Address is a unique value assigned at the factory. In most cases, the default value is sufficient. Clicking the Default button restores the MAC Address to the default value.</p>
Reply to ICMP PING	<p>If this field is disabled, the WAN connection will not respond to ICMP PING requests.</p> <p>By default, this is enabled.</p>
Additional Public IP Address	<p>The IP Address List represents the list of fixed Internet IP addresses assigned by the ISP, in the event that more than one Internet IP addresses are assigned to this WAN connection.</p> <p>Enter the fixed Internet IP addresses and the corresponding subnet mask, and then click the Down Arrow button to populate IP address entries to the IP Address List.</p>
IPv6	
IPv6	<p>IPv6 support can be enabled on one of the available Ethernet WAN ports. On this screen, you can choose which WAN will support IPv6.</p> <div data-bbox="406 1444 1404 1528" style="border: 1px solid black; padding: 5px;"><p>IPv6</p><p>Disabled </p></div> <p>To enable IPv6 support on a WAN, the WAN router must respond to Stateless Address Auto configuration advertisements and DHCPv6 requests. IPv6 clients on the LAN will acquire their IPv6, gateway, and DNS server addresses from it. The device will also acquire an IPv6 address for performing ping/traceroute checks and accepting web admin accesses.</p> <p>Note: This feature is only available on Pepwave MAX 700 and HD2.</p>

User Manual



PEPWAVE *MAX* mobile router

8.1.1 DHCP Connection

The DHCP connection method is suitable if the ISP provides an IP address automatically by DHCP (e.g. Satellite Modem, WiMAX Modem, Cable, Metro Ethernet, etc.).

There are three possible connection methods:

1. DHCP
2. Static IP
3. PPPoE

Connection Method	 DHCP
Routing Mode	 <input checked="" type="radio"/> NAT
IP Address	10.10.10.123
Subnet Mask	255.255.255.0
Default Gateway	10.10.10.1
DNS Servers	<input checked="" type="checkbox"/> Obtain DNS server address automatically <input type="checkbox"/> Use the following DNS server address(es) DNS Server 1: <input type="text"/> DNS Server 2: <input type="text"/>
Hostname (Optional)	<input type="text"/> <input type="checkbox"/> Use custom hostname



DHCP Settings	
Routing Mode	This is to substitute the real address in a packet with a mapped address that is routable on the destination network
IP Address/ Subnet Mask/ Default Gateway	This information is obtained from the ISP automatically.
DNS Servers	<p>Each ISP may provide a set of DNS servers for DNS lookups. This setting specifies the DNS (Domain Name System) Servers to be used when a DNS lookup is routed through this connection.</p> <p>Selecting Obtain DNS server address automatically results in the DNS Servers to be assigned by the WAN DHCP Server to be used for outbound DNS lookups over the connection. (The DNS Servers are obtained along with the WAN IP address assigned from the DHCP server.)</p> <p>When Use the following DNS server address(es) is selected, you may enter custom DNS server addresses for this WAN connection into the DNS Server 1 and DNS Server 2 fields.</p>
Hostname (Optional)	If your service provider's DHCP server requires you to supply a hostname value upon acquiring an IP address, you may enter the value here. If your service provider does not provide you with the value, you can safely bypass this option.

User Manual

PEPWAVE *MAX* mobile router

8.1.2 Static IP Connection

This Static IP connection method is suitable if ISP provides a static IP address to connect directly.

Connection Method	 Static IP ▾
Routing Mode	 <input checked="" type="radio"/> NAT
IP Address	<input type="text"/>
Subnet Mask	255.255.255.0 (/24) ▾
Default Gateway	<input type="text"/>
DNS Servers	<input checked="" type="checkbox"/> Use the following DNS server address(es) DNS Server 1: <input type="text"/> DNS Server 2: <input type="text"/>



Static IP Settings	
Routing Mode	This is to substitute the real address in a packet with a mapped address that is routable on the destination network
IP Address / Subnet Mask / Default Gateway	<p>These settings allow you to specify the information required in order to communicate on the Internet via a fixed Internet IP address.</p> <p>The information is typically determined by and can be obtained from the ISP.</p>
DNS Servers	<p>Each ISP may provide a set of DNS servers for DNS lookups. This field specifies the DNS (Domain Name System) Servers to be used when a DNS lookup is routed through this connection.</p> <p>You can input the ISP provided DNS server addresses into the DNS Server 1 and DNS Server 2 fields. If no address is entered here, this link will not be used for DNS lookups.</p>

User Manual

PEPWAVE *MAX* mobile router

8.1.3 PPPoE Connection

This connection method is suitable if ISP provides login ID/ password to connect via PPPoE.

Connection Method	 PPPoE ▾
Routing Mode	 <input checked="" type="radio"/> NAT
IP Address	10.10.10.123
Subnet Mask	255.255.255.0
Default Gateway	10.10.10.1
PPPoE User Name	<input type="text"/>
PPPoE Password	<input type="password"/>
Confirm PPPoE Password	<input type="password"/>
Service Name (Optional)	<input type="text"/> Leave it blank unless it's provided by ISP
DNS Servers	<input type="checkbox"/> Obtain DNS server address automatically <input type="checkbox"/> Use the following DNS server address(es) DNS Server 1: <input type="text"/> DNS Server 2: <input type="text"/>

PPPoE Settings	
Routing Mode	This is to substitute the real address in a packet with a mapped address that is routable on the destination network
IP Address / Subnet Mask / Default Gateway	This information is obtained from the ISP automatically.
PPPoE User Name / Password	Enter the required information in these fields in order to connect via PPPoE to the ISP. The parameter values are determined by and can be obtained from the ISP.
Confirm PPPoE Password	Verify your password by entering it again in this field.
Service Name	Service Name is provided by the ISP. Note: Leave this field blank unless it is provided by your ISP.
DNS Servers	<p>Each ISP may provide a set of DNS servers for DNS lookups. This setting specifies the DNS (Domain Name System) Servers to be used when a DNS lookup is routed through this connection.</p> <p>Selecting Obtain DNS server address automatically results in the DNS Servers assigned by the PPPoE server to be used for outbound DNS lookups over the WAN connection. (The DNS Servers are obtained along with the WAN IP address assigned from the PPPoE server.)</p> <p>When Use the following DNS server address(es) is selected, you can put custom DNS server addresses for this WAN connection into the DNS Server 1 and DNS Server 2 fields.</p>

User Manual

PEPWAVE *MAX* mobile router

8.1.4 Dynamic DNS Settings

Pepwave MAX provides the functionality to register the domain name relationships to dynamic DNS service providers. Through registration with dynamic DNS service provider(s), the default public Internet IP address of each WAN connection can be associated with a host name. With Dynamic DNS service enabled for a WAN connection, you can connect to your WAN's IP address from the external even if its IP address is dynamic. You have to register for an account from the listed dynamic DNS service providers before enabling this option.

If the WAN connection's IP address is a reserved private IP address (i.e. behind a NAT router), the Public IP of each WAN will be automatically reported to the DNS service provider.

Either upon a change in IP addresses or every 23 days without link reconnection, Pepwave MAX will connect to the dynamic DNS service provider to perform an IP address update within the provider's records.

The settings for dynamic DNS service provider(s) and the association of host name(s) are configured via **Network > WAN > Click on WAN Detail**

Either upon a change in IP address or every 23 days without link reconnection, Pepwave MAX will connect to the dynamic DNS service provider to perform an IP address update within the provider's records.

Dynamic DNS	?	Disabled	
Bandwidth Allowance Monitor	?	Disabled	
Port Speed	?	changeip.com	
MTU	?	dyndns.org	
MSS	?	no-ip.org	
MAC Address Clone	?	tzo.com	
VLAN		DNS-O-Matic	Form Value: 1440 <input type="button" value="Default"/>
Reply to ICMP PING	?	<input checked="" type="radio"/> Auto <input type="radio"/> Custom Value: <input type="text"/>	
		00 : 1A : DD : BD : 1E : 41	<input type="button" value="Default"/>
		<input type="checkbox"/>	
		<input checked="" type="radio"/> Yes <input type="radio"/> No	

Dynamic DNS Settings

Dynamic DNS

This setting specifies the dynamic DNS service provider to be used for the WAN based on supported dynamic DNS service providers:

- changeip.com
- dyndns.org
- no-ip.org
- tzo.com
- DNS-O-Matic

Select **Disabled** to disable this feature.

Account Name / Email Address

This setting specifies the registered user name for the dynamic DNS service.

Password / TZO Key

This setting specifies the password for the dynamic DNS service.

Hosts / Domain

This field allows you to specify a list of host names or domains to be associated with the public Internet IP address of the WAN connection.

If you need to enter more than one host, you can use a carriage return to separate them.

User Manual

PEPWAVE *MAX* mobile router

Important Note

In order to use dynamic DNS services, appropriate host name registration(s) as well as a valid account with a supported dynamic DNS service provider are required.

A dynamic DNS update is performed whenever a WAN's IP address changes. E.g. IP is changed after a DHCP IP refresh, reconnection, etc.

Due to dynamic DNS service providers' policy; a dynamic DNS host will automatically expire if the host record has not been updated for a long time. Therefore Pepwave MAX performs an update every 23 days even if a WAN's IP address has not changed.

User Manual

PEPWAVE *MAX* mobile router

8.2 Cellular 1 / Cellular 2

Network > WAN > Click on Detail [Details](#)



The screenshot shows the 'WAN Connection Status' interface. It is organized into several sections: Priority 1 (Highest), Priority 2, Priority 3, and Disabled. Each section contains a list of connection types with their current status and a 'Details' button. The 'Cellular 1' and 'Cellular 2' entries are highlighted with a yellow box.

WAN Connection Status		
Priority 1 (Highest)		
1 WAN 1	<input checked="" type="checkbox"/> Connected	Details
2 WAN 2	<input checked="" type="checkbox"/> Connected	Details
Priority 2		
1 Cellular 1	<input type="checkbox"/> Standby	Details
Priority 3		
Drag desired (Priority 3) connections here		
Disabled		
Wi-Fi WAN	<input type="checkbox"/> Disabled	Details
2 Cellular 2	<input type="checkbox"/> Disabled	Details

(Available on Pepwave MAX HD2 only)

User Manual

PEPWAVE *MAX* mobile router

Connection Details ✕

Cellular 1 Status	
SIM Card IMSI	#54000048026562
MEID HEX	A100001F70C109
MEID DEC	270113180708241417
ESN	80C2C083
IMEI	356144040033959
Carrier	CSL
Country/Region	China, Hong Kong
Signal Strength	-73 dBm
IP Address	10.35.215.243
DNS Server	10.11.110.101 10.11.105.102

Network Mode HSPA Sprint,EV-DO Verizon Wireless,EV-DO

Cellular 1 Settings	
WAN Connection Name	Cellular 1 Default
Standby State	<input checked="" type="radio"/> Remain Connected <input type="radio"/> Disconnected
Idle Disconnect	<input type="checkbox"/>
Operator Settings	<input checked="" type="radio"/> Auto <input type="radio"/> Custom
APN	cmwap
Login	-
Password	-
SIM PIN (Optional)	<input type="text"/>
Health Check Settings	
Method	DNS Lookup ▾
Health Check DNS Servers	Host 1: <input type="text"/> Host 2: <input type="text"/> <input checked="" type="checkbox"/> Use first two DNS servers as Health Check DNS Servers <input type="checkbox"/> Include public DNS servers
Timeout	5 ▾ second(s)
Health Check Interval	5 ▾ second(s)
Health Check Retries	3 ▾
Recovery Retries	3 ▾
Dynamic DNS	Disabled ▾
Bandwidth Allowance Monitor	<input type="checkbox"/>
MTU	1440 Default

Save and Apply
Cancel

User Manual

PEPWAVE *MAX* mobile router

Cellular 1 / Cellular 2	
SIM Card IMSI	This is the International Mobile Subscriber Identity which uniquely identifies the SIM card. This is applicable to 3G modems only.
MEID HEX	The Pepwave MAX supports both HSPA and EV-DO. For Sprint or Verizon Wireless EV-DO users, a unique MEID identifier code (in hexadecimal format) is used by the carrier to associate the EV-DO device with the user.
MEID DEC	This is the equivalent of the MEID HEX but in decimal format.
ESN	This serves the same purpose as MEID HEX but uses an older format.
IMEI	This is the unique ID for identifying the modem in GSM/HSPA mode.
Network Mode	Users have to specify the Network they are on accordingly.
WAN Connection Name	This field is for defining a name to represent this WAN connection.
Standby State	This option allows you to choose whether to remain the connection connected or disconnected when this WAN connection is no longer in the highest priority and has entered the standby state. When Remain connected is chosen, upon bringing up this WAN connection to active, it will be immediately available for use.
Idle Disconnect	When Internet traffic is not detected within the user specified timeframe, the modem will automatically disconnect. Once the traffic is resumed by the LAN host, the connection will be re-activated,
Operator Settings	This setting applies to 3G / EDGE / GPRS modem only. It does not apply to EVDO / EVDO Rev. A modem. This allows you to configure the APN settings of your connection. If Auto is selected, the mobile operator should be detected automatically. The connected device will be configured and connection will be made automatically afterwards. If there is any difficulty in making connection, you may select Custom to enter your carrier's APN, Login, Password, and Dial Number settings manually. The correct values can be obtained from your carrier. The default and recommended Operator Settings is Auto .
APN / Login / Password / SIM PIN	When Auto is selected, the information in these fields will be filled automatically. Select the option Custom and you may customize these parameters. The parameters values are determined by and can be obtained from the ISP.
Health Checking Settings	This setting allows you to specify the health check method for the Cellular connection. The as available options are Disabled and DNS Lookup . The default method is DNS Lookup . See Section 8.4 for configuration details.
Bandwidth Allowance Monitor	This option allows you to enable bandwidth usage monitoring on this WAN connection for each billing cycle. When this is not enabled, bandwidth usage of each month is still being tracked but no action will be taken. See Section 8.5 for configuration details.

User Manual

PEPWAVE *MAX* mobile router

8.3 Wi-Fi WAN

Network > WAN > Click on *Wi-Fi WAN* [Details](#)

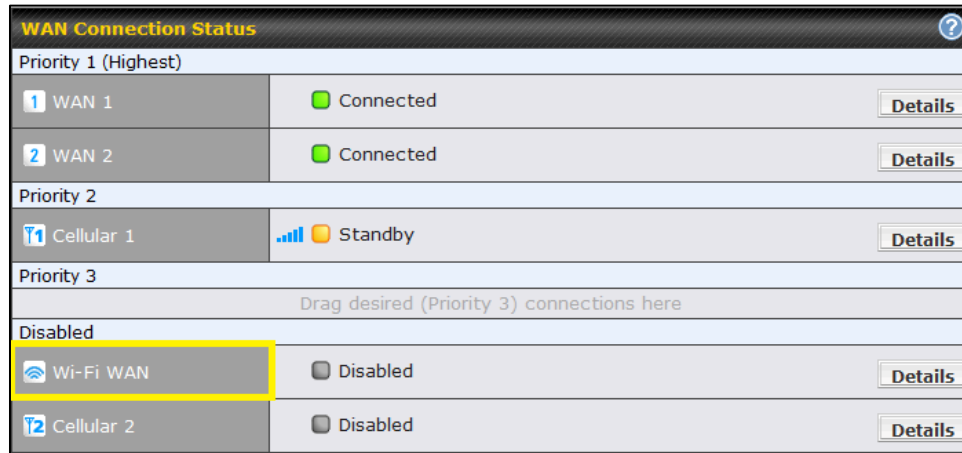

User Manual

PEPWAVE *MAX* mobile router

Connection Details ✕

Wi-Fi WAN	
WAN Connection Name	Wi-Fi WAN Default
Standby State ?	<input checked="" type="radio"/> Remain connected <input type="radio"/> Disconnect
Health Check Method ?	DNS Lookup ▾
Health Check DNS Servers ?	Server 1: <input style="width: 150px;" type="text"/> Server 2: <input style="width: 150px;" type="text"/> <input checked="" type="checkbox"/> Use first two DNS servers as Health Check DNS Servers <input type="checkbox"/> Include public DNS servers <input type="checkbox"/>
Timeout ?	5 ▾ second(s)
Health Check Interval ?	5 ▾ second(s)
Health Check Retries ?	3 ▾
Recovery Retries	3 ▾
Dynamic DNS	Disabled ▾
Bandwidth Allowance Monitor ?	<input type="checkbox"/> Enable
MTU	<input type="radio"/> Auto <input checked="" type="radio"/> Manual Value: 1500 Default
Connect to Any Open Mode AP ?	<input type="radio"/> Yes <input checked="" type="radio"/> No
Reply to ICMP PING ?	<input checked="" type="radio"/> Yes <input type="radio"/> No

Wi-Fi Connection Profiles (In signal strength mode, the following profile order is not used) ?

Network Name (SSID)	Security	
Wi-Fi Hotspot2	Open	✕
Wi-Fi Hotspot1	🔒 WPA/WPA2-Personal	✕

[Create Profile...](#)

Save and Apply
Cancel

Wi-Fi WAN Settings	
WAN Connection Name	This field is for defining a name to represent this WAN connection.
Standby State	This setting specifies the state of the WAN connection while in standby. The available options are Remain Connected (hot standby) and Disconnect (cold standby).
Health Check Method	This setting allows you to specify the health check method for the WAN connection. The available options are Disabled , Ping , and DNS Lookup . The default method is Disabled .

User Manual

PEPWAVE *MAX* mobile router

8.3.1 Create Wi-Fi Connection Profile

You can manually create a profile to connect to a Wi-Fi connection. It is useful for creating a profile for connecting to hidden-SSID access points. Click on the link **Create Profile...** and the following window will be displayed.

Network > WAN > Click on Detail Details

The screenshot shows the 'Connection Details' window for a Wi-Fi WAN connection. The window title is 'Connection Details' with a close button (X) in the top right corner. The main content area is titled 'Wi-Fi WAN' and contains the following configuration options:

WAN Connection Name	Wi-Fi WAN Default
Standby State	<input checked="" type="radio"/> Remain connected <input type="radio"/> Disconnect
Health Check Method	DNS Lookup
Health Check DNS Servers	Server 1: <input type="text"/> Server 2: <input type="text"/> <input checked="" type="checkbox"/> Use first two DNS servers as Health Check DNS Servers <input type="checkbox"/> Include public DNS servers
Timeout	5 second(s)
Health Check Interval	5 second(s)
Health Check Retries	3
Recovery Retries	3
Dynamic DNS	Disabled
Bandwidth Allowance Monitor	<input type="checkbox"/> Enable
Connect to Any Open Mode AP	<input type="radio"/> Yes <input checked="" type="radio"/> No
Reply to ICMP PING	<input checked="" type="radio"/> Yes <input type="radio"/> No

Below the configuration table is a section titled 'Wi-Fi Connection Profiles (In signal strength mode, the following profile order is not used)'. It contains a table with two columns: 'Network Name (SSID)' and 'Security'. The table is currently empty, with the text 'No Wi-Fi connection profiles found.' below it. A blue link 'Create Profile...' is located below the table. At the bottom of the window are two buttons: 'Save and Apply' and 'Cancel'.

Click on **Create Profile....**

The screenshot shows the 'Wi-Fi Connection Profiles' window. The window title is 'Wi-Fi Connection Profiles (In signal strength mode, the following profile order is not used)'. It contains a table with two columns: 'Network Name (SSID)' and 'Security'. The table is currently empty, with the text 'No Wi-Fi connection profiles found.' below it. A blue link 'Create Profile...' is highlighted with a yellow box below the table. At the bottom of the window are two buttons: 'Save and Apply' and 'Cancel'.

This will open a window similar to the shown below

User Manual

PEPWAVE *MAX* mobile router

Wi-Fi Connection	
Network Name (SSID)	Wi-Fi Hotspot
Security	Open
IP Address	<input checked="" type="radio"/> Obtain an IP address automatically <input type="radio"/> Static

Create Wi-Fi Connection Profile Settings

Network Name (SSID)	This field is for defining a name to represent this Wi-Fi connection.																						
Security	<p>This option allows you to select which security policy is used for this wireless network. Available options:</p> <ul style="list-style-type: none"> Open <table border="1"> <tr> <td>Security</td> <td>Open</td> </tr> </table> WEP <table border="1"> <tr> <td>Security</td> <td>WEP</td> </tr> <tr> <td>Encryption Key</td> <td><input type="text"/></td> </tr> <tr> <td></td> <td><input checked="" type="checkbox"/> Hide Characters</td> </tr> </table> WPA/WPA2 – Personal <table border="1"> <tr> <td>Security</td> <td>WPA/WPA2-Personal</td> </tr> <tr> <td>Shared Key</td> <td><input type="text"/></td> </tr> <tr> <td></td> <td><input checked="" type="checkbox"/> Hide Characters</td> </tr> </table> WPA/WPA2 – Enterprise <table border="1"> <tr> <td>Security</td> <td>WPA/WPA2-Enterprise</td> </tr> <tr> <td>Login ID</td> <td><input type="text"/></td> </tr> <tr> <td>Password</td> <td><input type="text"/></td> </tr> <tr> <td>Password Again</td> <td><input type="text"/></td> </tr> </table> <p>The settings to be displayed under this row will vary depending on the selected security policy.</p>	Security	Open	Security	WEP	Encryption Key	<input type="text"/>		<input checked="" type="checkbox"/> Hide Characters	Security	WPA/WPA2-Personal	Shared Key	<input type="text"/>		<input checked="" type="checkbox"/> Hide Characters	Security	WPA/WPA2-Enterprise	Login ID	<input type="text"/>	Password	<input type="text"/>	Password Again	<input type="text"/>
Security	Open																						
Security	WEP																						
Encryption Key	<input type="text"/>																						
	<input checked="" type="checkbox"/> Hide Characters																						
Security	WPA/WPA2-Personal																						
Shared Key	<input type="text"/>																						
	<input checked="" type="checkbox"/> Hide Characters																						
Security	WPA/WPA2-Enterprise																						
Login ID	<input type="text"/>																						
Password	<input type="text"/>																						
Password Again	<input type="text"/>																						

User Manual

PEPWAVE *MAX* mobile router

8.4 WAN Health Check

To ensure traffic is routed to healthy WAN connections only, Pepwave MAX provides the functionality to periodically check the health of each WAN connection.

The Health Check settings for each WAN connection can be independently configured via **Network > WAN > Details**:

WAN Port	
WAN Connection Name	WAN 1 Default
Connection Method	Static IP
IP Address	172.11.22.10
Subnet Mask	255.255.255.0 (/24)
Default Gateway	172.11.22.2
DNS Servers	<input checked="" type="checkbox"/> Use the following DNS server address(es) DNS Server 1: <input type="text"/> DNS Server 2: <input type="text"/>
Standby State	<input checked="" type="radio"/> Remain connected <input type="radio"/> Disconnect
Upstream Bandwidth	1000 Mbps
Downstream Bandwidth	1000 Mbps
Health Check Method	Disabled Disabled. Network problem cannot be detected.
Dynamic DNS	PING
Bandwidth Allowance Monitor	DNS Lookup
Port Speed	Auto
MTU	<input type="radio"/> Auto <input checked="" type="radio"/> Custom Value: 1440 Default
MSS	<input checked="" type="radio"/> Auto <input type="radio"/> Custom Value: <input type="text"/>

Enable the Health Check Settings by drop down to PING, DNS Lookup and HTTP

User Manual

PEPWAVE *MAX* mobile router

Health Check Settings

Method

This setting specifies the health check method for the WAN connection. The value of Method can be configured as **Disabled**, **Ping** or **DNS Lookup**. The default method is **DNS Lookup**.

For Mobile Internet connection, the value of Method can be configured as **Disabled** or **SmartCheck**.

Health Check Disabled

Health Check Method	<input type="text" value="Disabled"/>	Health Check disabled. Network problem cannot be detected.
---------------------	---------------------------------------	--

When **Disabled** is chosen in the Method field, the WAN connection will always be considered as up. The connection will not be treated as down in the event of IP routing errors.

Health Check Method: PING

Health Check Method	<input type="text" value="PING"/>
PING Hosts	Host 1: <input type="text"/> Host 2: <input type="text"/> <input checked="" type="checkbox"/> Use first two DNS servers as PING Hosts

The ICMP PING packets will be issued to test the connectivity with a configurable target IP address or host name. A WAN connection is considered as up if PING responses are received from either one or both of the PING Hosts.

PING Hosts

This setting specifies IP addresses or host names with which connectivity is to be tested via ICMP Ping.

If **Use first two DNS servers as Ping Hosts** is checked, the target PING Host will be the first DNS server for the corresponding WAN connection.

Reliable PING hosts with a high uptime should be considered.

By default, the first two DNS servers of the WAN connection are used as the PING Hosts.

Health Check Method: DNS Lookup

Health Check Method	<input type="text" value="DNS Lookup"/>
Health Check DNS Servers	Host 1: <input type="text"/> Host 2: <input type="text"/> <input checked="" type="checkbox"/> Use first two DNS servers as Health Check DNS Servers <input type="checkbox"/> Include public DNS servers

DNS lookups will be issued to test the connectivity with target DNS servers. The connection will be treated as up if DNS responses are received from either one or both of the servers, regardless of whether the result was positive or negative.

Health Check DNS Servers

This field allows you to specify two DNS hosts' IP address with which connectivity is to be tested via DNS Lookup.

If **Use first two DNS servers as Health Check DNS Servers** is checked, the first two DNS servers will be the DNS lookup targets for checking a connection's health. If the box is not checked, field Host 1 must be filled and field Host 2 is optional.

If the box **Include public DNS servers** is selected and no response is received from all specified DNS servers, DNS lookups will also be issued to some public DNS servers. A

User Manual

PEPWAVE *MAX* mobile router

WAN connection will be treated as down only if there is also no response received from the public DNS servers.

Connections will be considered up if DNS responses are received from any one of the health check DNS servers, regardless of a positive or negative result.

By default, the first two DNS servers of the WAN connection are used as the Health Check DNS Servers.

Health Check Method: HTTP

Health Check Method		HTTP
---------------------	---	------







HTTP connections will be issued to test the connectivity with configurable URLs and strings to match.

URL 1

WAN Settings > WAN Edit > Health Check Settings > URL 1

The URL will be retrieved when performing an HTTP health check. When *String to Match* is left blank, a health check will pass if the HTTP return code is between 200 and 299 (Note: HTTP redirection codes 301 or 302 are treated as failures). When *String to Match* is filled, a health check will pass if the HTTP return code is between 200 and 299 and if the HTTP response content contains the string

URL 2

Health Check Method		HTTP
URL 1		http:// <input type="text"/>
		Matching String: <input type="checkbox"/>
URL 2		http:// <input type="text"/>
		Matching String: <input type="checkbox"/>
Timeout		10 seconds(s)
Health Check Interval		5 seconds(s)
Health Check Retries		3
Recovery Retries		3





WAN Settings > WAN Edit > Health Check Settings > URL 2

If URL 2 is also provided, a health check will pass if either one of the tests passed.

User Manual

PEPWAVE *MAX* mobile router

Other Health Check Settings

Timeout		5	second(s)
Health Check Interval		5	second(s)
Health Retries		3	
Recovery Retries		3	

Timeout This setting specifies the timeout, in seconds, for ping/DNS lookup requests. Default Timeout is set to **5** second.

Health Check Interval This setting specifies the time interval, in seconds, between ping or DNS lookup requests. Default Health Check Interval is **5** seconds.

Health Check Retries This setting specifies the number of consecutive ping/DNS lookup timeouts after which Pepwave MAX is to treat the corresponding WAN connection as down. Default Health Retries is set to **3**.
For example, with the default Health Retries setting of 3, after consecutive 3 timeouts, the corresponding WAN connection will be treated as down.

Recovery Retries This setting specifies the number of consecutive successful ping/DNS lookup responses that must be received before Pepwave MAX treats a previously down WAN connection to be up again.
By default, Recover Times is set to **3**. For example, a WAN connection that is treated as down will be considered to be up again upon receiving 3 consecutive successful ping/DNS lookup responses.

Automatic Public DNS Server Check on DNS Test Failure

In case the health check method is set to DNS Lookup and checks failed, the MAX will automatically perform DNS lookups on some public DNS servers. If the tests are success, it means the WAN may not be down but rather the target DNS server became malfunctioned. You will see the following warning message on the Main page.

 **Failed to receive DNS response from the health-check DNS servers for WAN connection 3. But public DNS server lookup test via the WAN passed. So please check the DNS server settings.**

User Manual



PEPWAVE *MAX* mobile router

8.5 Bandwidth Allowance Monitor

Bandwidth Allowance Monitor helps keep track of your network usage.

Bandwidth Allowance Monitor 	<input type="checkbox"/> Enable
---	---------------------------------

Enable Bandwidth Allowance Monitor

Bandwidth Allowance Monitor 	<input checked="" type="checkbox"/> Enable
Action 	Email notification is currently disabled. You can get notified when usage hits 75%/95% of monthly allowance by enabling Email Notification . <input checked="" type="checkbox"/> Disconnect when usage hits 100% of monthly allowance
Start Day	On 1st of each month at 00:00 midnight
Monthly Allowance	<input type="text"/> GB

Bandwidth Allowance Monitor	
Action	If the feature Email Notification is enabled, you will be notified through email when usage hits 75% and 95% of the monthly allowance. If the box Disconnect when usage hits 100% of monthly allowance is checked, this WAN connection will be disconnected automatically when the usage hits the monthly allowance. It will not resume connection unless this option has been turned off or the usage has been reset when a new billing cycle starts.
Start Day	This option allows you to define which day in the month each billing cycle begins.
Monthly Allowance	This field is for defining the maximum bandwidth usage allowed for the WAN connection each month.

User Manual

PEPWAVE *MAX* mobile router

9 Wi-Fi Settings

Wi-Fi settings can be configured at **Advanced > Wi-Fi Settings**

Wi-Fi AP Radio Settings	
Protocol	802.11n/g
Operating Country	United States
Channel	1 (2.412 GHz)
Channel Width	Auto (20/40 MHz)
Bit Rate	Auto
Output Power	Max <input type="checkbox"/> Boost

Wi-Fi WAN Radio Settings	
Channel Width	20/40 MHz
Bit Rate	Auto
Output Power	Max <input type="checkbox"/> Boost

Wi-Fi AP Advanced Settings	
STP	<input type="checkbox"/> Enable
Layer 2 Isolation	<input type="checkbox"/> Enable
802.1X Version	<input type="radio"/> V1 <input checked="" type="radio"/> V2
Beacon Rate	1Mbps
Beacon Interval	100ms
DTIM	1
Slot Time	9 μ s
ACK Timeout	48 μ s
Frame Aggregation	<input checked="" type="checkbox"/> Enable
Guard Interval	<input type="radio"/> Short <input checked="" type="radio"/> Long

Wi-Fi AP Radio Settings	
Protocol	This option allows you to specify whether 802.11b and/or 802.11g client association requests will be accepted. Available options are 802.11b/g , 802.11b Only , and 802.11g Only . By default, 802.11b/g is selected.
Operating Country	This option set the country whose regulations the Pepwave MAX follows.
Channel	This option allows you to select which 802.11 RF channel will be utilized. Channel 1 (2.412 GHz) is selected by default.
Channel Width	Options Auto (20/40 MHz) and 20 MHz are available. Default is Auto (20/40 MHz) , which allows both widths to be used simultaneously.
Bit Rate	This option allows you to select a specific bit rate for data transfer over the device's Wi-Fi network. By default, Auto is selected.
Output Power	This option is for specifying the transmission output power for the Wi-Fi AP. There are 4 relative power levels available – Max, High, Mid and Low. The actual

User Manual

PEPWAVE *MAX* mobile router

output power will be bound by the regulatory limits of the selected country. By default, **23 dBm (200 mW)** or **20 dBm (100 mW)** (depending on which operating country you have chosen in the previous section) is selected.

Wi-Fi WAN Radio Settings

Channel Width	Options Auto (20/40 MHz) and 20 MHz are available. Default is Auto (20/40 MHz) , which allows both widths to be used simultaneously.
Bit Rate	This option allows you to select a specific bit rate for data transfer over the device's Wi-Fi network. By default, Auto is selected.
Output Power	This option is for specifying the transmission output power for the Wi-Fi AP. There are 4 relative power levels available – Max, High, Mid and Low. The actual output power will be bound by the regulatory limits of the selected country. By default, 23 dBm (200 mW) or 20 dBm (100 mW) (depending on which operating country you have chosen in the previous section) is selected.



Wi-Fi AP Advanced Settings

STP	This option allows you to enable the Spanning Tree Protocol to prevent path redundancy. By default, it is disabled. See Section Error! Reference source not found. for details.
Layer 2 Communication	This option allows you to choose whether clients on the network should be able to communicate with each other directly. If the checkbox Enable is selected, clients are allowed to communicate with each other directly, and traffic will not be passed to any uplink equipment. If this option is disabled, clients are not allowed to communicate directly. Traffic will be passed to uplink equipment/uplink routers before communication can be established among clients. By default, it is enabled .
802.1X Version	This option allows you to select between V1 or V2 of the 802.1X EAPOL. When V1 is selected, both V1 and V2 clients are allowed to associate with this Wi-Fi AP. When V2 is selected, only V2 clients can associate with this Wi-Fi AP. Most wireless clients support V2. Select the option V1 in case if there are stations that do not support V2. By default, V2 is selected.
Beacon Rate	This option is for setting the transmit bit rate for sending a beacon. By default, 1Mbps is selected.
Beacon Interval	This option is for setting the time interval between each beacon. By default, 100ms is selected.
DTIM	This field allows you to set the frequency for the beacon to include Delivery Traffic Indication Message. The interval is measured in millisecond. The default value is set to 1 ms .
Slot Time	This field is for specifying the unit wait time before it transmits a packet. By default, this field is set to 9 µs .

User Manual

PEPWAVE *MAX* mobile router

ACK Timeout	This field is for setting the wait time to receive an acknowledgement packet before performing a retransmission. By default, this field is set to 48 µs .
Channel Bonding	There are 3 selections available in this setting. The first is 20 where the channel bonding is off and the channel width is 20 MHz. If 20/40 is selected, the AP will automatically choose the channel widths between 20 and 40 MHz. If 40 is chosen, channel bonding will be enforced and, the channel width will just be 40 MHz.
Frame Aggregation	This option allows you to enable frame aggregation to increase transmission throughput.
Guard Interval	This is where you opt for a short or long guard period interval for your transmissions.

Wi-Fi AP Advanced Settings		
STP		<input checked="" type="checkbox"/> Enable
Bridge Priority		32768
Ethernet Path Cost		100

STP Settings

Bridge Priority	This parameter is set to give the likeliness for root switch election. By default, it is set to 32768 .
Ethernet Path Cost	This parameter specifies the preference to provide the best path from the switch to the root switch. By default, it is set to 100 .

User Manual

PEPWAVE *MAX* mobile router

10 Bandwidth Bonding SpeedFusion™



Pepwave Bandwidth Bonding SpeedFusion™ functionality securely connects your MAX indifferent branch to another Pepwave MAX or Peplink device (only Peplink Balance 210/310/380/580/710/1350 are available for this function). The data, voice, or video communications between these locations are kept confidential across the public Internet.

The Bandwidth Bonding SpeedFusion™ of the Pepwave MAX is specifically designed for multi-WAN environment. The Pepwave MAX can aggregate all WAN connections' bandwidth for routing SpeedFusion™ traffic. Unless all the WAN connections of one site are down, the Pepwave MAX can still maintain VPN up and running.

VPN Bandwidth Bonding is supported in firmware 5.1 or above. All available bandwidth will be utilized to establish the VPN tunnel, and all traffic will be load balanced at packet level across all links. VPN Bandwidth Bonding is enabled by default.

User Manual

PEPWAVE *MAX* mobile router

10.1 SpeedFusion™

The screenshot shows the PEPWAVE web interface for configuring SpeedFusion™ VPN Bonding. The navigation menu on the left includes: Advanced (Wi-Fi Settings, SpeedFusion™, IPsec VPN, Outbound Policy, Port Forwarding), NAT Mappings, QoS (User Groups, Bandwidth Control, Application), Firewall, and Misc. Settings (PPTP Server, Service Forwarding, Service Passthrough). The main content area is titled "SpeedFusion™ VPN Bonding" and includes a "256bit AES" security icon. A table lists existing profiles:

Profile	Remote ID	Remote Address(es)
FL Office	1824-5F7E-FF03	10.80.11.1

Below the table is a "New Profile" button. Further down, the "SpeedFusion™" section shows "Local ID" set to "MAX_HD2_DE1F". The "Link Failure Detection" section has "Link Failure Detection Time" set to "Recommended (Approx. 15 secs)" with other options: "Fast (Approx. 6 secs)", "Faster (Approx. 2 secs)", and "Extreme (Under 1 sec)". A note states: "Shorter detection time incurs more health checks and higher bandwidth overhead." A "Save" button is at the bottom of this section.

Pepwave MAX supports making two SpeedFusion™ connections with a remote Pepwave MAX unit or a Peplink Balance 210/310/380/580/710/1350.

The local LAN subnet and subnets behind the LAN (defined under **Static Route** in the LAN settings page) will be advertised to the VPN. All VPN members (branch offices and headquarters) will be able to route to the local subnets.

Note that all LAN subnet and subnets behind it have to be unique. Otherwise, VPN members will not be able to access each other.

All data can be routed over the VPN with 256-bit AES encryption standard.

To configure, navigate to **Advanced > SpeedFusion™**, click the **New Profile** button

 to create a new VPN profile.

Once you click on New Profile button this will open a window

Click on OK 

User Manual

PEPWAVE *MAX* mobile router

SpeedFusion™ Profile	
Name	<input type="text"/>
Active	<input checked="" type="checkbox"/>
Encryption	<input checked="" type="radio"/> 256-bit AES <input type="radio"/> Off
Remote ID	<input type="text"/>
Pre-shared Key (Optional)	<input type="text"/> <input checked="" type="checkbox"/> Hide Characters
Remote IP Addresses / Host Names (Optional)	<input type="text"/> <small>If this field is empty, this field on the remote unit must be filled</small>
Data Port	<input checked="" type="radio"/> Default <input type="radio"/> Custom <input type="text"/>

WAN Connection Priority	
1. WAN 1	Priority: 1 (Highest) ▼
2. WAN 2	Priority: 1 (Highest) ▼
3. Wi-Fi WAN	Priority: 1 (Highest) ▼
4. Cellular 1	Priority: 1 (Highest) ▼
5. Cellular 2	Priority: 1 (Highest) ▼
6. USB	Priority: 1 (Highest) ▼

A list of defined **VPN Connection** profiles and **Link Failure Detection Time** option will be shown.

Click the **New Profile** button to create a new VPN connection profile for making VPN connection to a remote Peplink Balance/Peppwave MAX via the available WAN connections. Each profile is for making VPN connection with one remote Peplink Balance/Peppwave MAX.

You can check the status of the connection from:

Status > SpeedFusion™

User Manual

PEPWAVE *MAX* mobile router

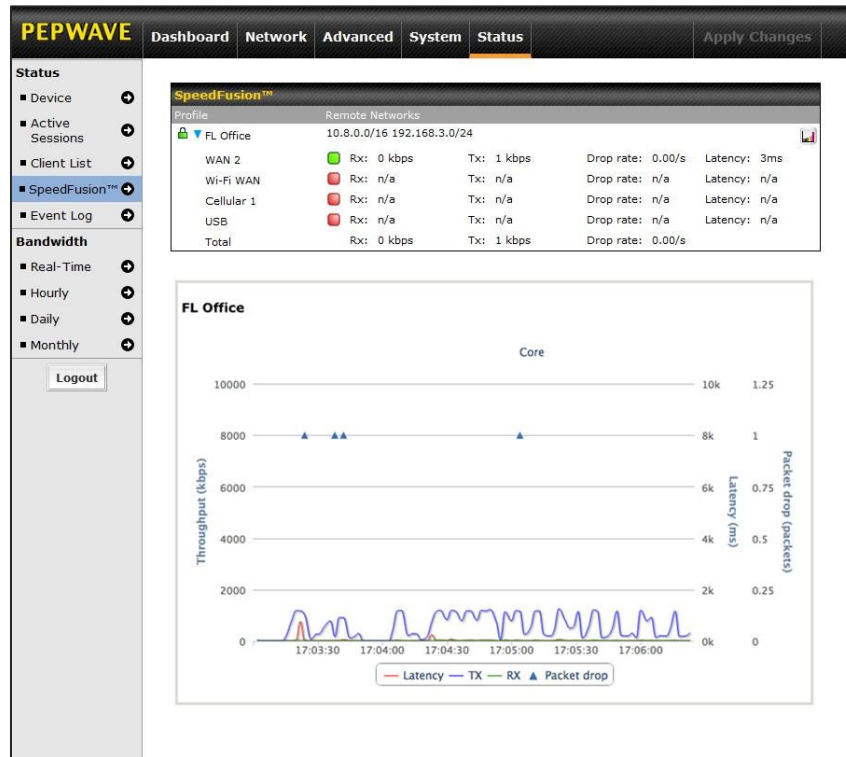

VPN Settings

Active	Check this box to enable the VPN.
Encryption	By default, VPN traffic is encrypted with 256-bit AES standard. If the option Off is selected on both sides of a VPN connection, no encryption will be applied.
Remote ID	Pepwave MAX establishes VPN connection with a remote peer that has a serial number or a remote ID here.
Pre-shared Key	This is an optional field which defines the pre-shared key used for this particular VPN connection. The VPN connection's session key will be further protected by the factor of the pre-shared key. The connection will be up only if the pre-shared keys on each side match. When the remote peer is running firmware 5.0 or 5.1, this setting will be ignored.
Remote IP Addresses / Host Names	Enter the remote peer's WAN IP address(es) or host name(s) here. Dynamic-DNS host names are accepted. This field is optional. With this field filled, the Pepwave MAX will initiate connection to each of the remote IP addresses until success. If the field is empty, the Pepwave MAX will wait for connection from the remote peer. Therefore, at least one side of the two VPN peers has to have the field filled. Otherwise, VPN connection cannot be established. Enter one IP address or host name per line.
Data Port	If Default is selected, VPN data will go through UDP port 4500. Select Custom and enter a port number if a specific outgoing port is desired.

User Manual

PEPWAVE *MAX* mobile router

<p>Layer 2 Bridging</p>	<p>When this check box is unchecked, traffic between local and remote networks will be IP forwarded.</p> <p>To bridge the Ethernet network of an Ethernet port on a local and remote network, select this check box. When this check box is selected, the two networks will become a single LAN, and any broadcast (e.g., ARP requests) or multicast traffic (e.g., Bonjour) will be sent over the VPN.</p> <p>The L2 bridging feature is hidden from the user interface by default. To enable this feature, user has to click the hidden link at the upper right corner of the SpeedFusion™ Profile table.</p>
<p>Bridge port</p>	<p>This field specifies the port to be bridged to the remote site.</p> <p>If you choose WAN X (internal: replace the X by the WAN port number) that WAN will be disabled for WAN purposes. Instead, the WAN port will be dedicated to bridging with the remote site. The LAN port will remain unchanged.</p>
<p>VLAN Tagging</p>	<p>This field specifies the VLAN ID with which the VPN's traffic should be tagged before sending the traffic to the bridge port. If no VLAN tagging is needed, select No VLAN. To define a new VLAN ID, click New... and input the VLAN ID. VLAN IDs that are not referenced by any VPN profiles will be removed from the list automatically. Default: No VLAN</p>
<p>STP</p>	<p>Checking this box enables Spanning Tree Protocol.</p> <p>Default: Unchecked.</p>
<p>Preserve LAN Settings Upon Connected</p>	<p>The LAN port is chosen as the bridge port. Selecting this option preserves LAN settings (e.g., LAN port IP address, DHCP server, etc.) when the Layer 2 VPN is connected. Uncheck this option if the LAN IP address and gateway will use remote LAN settings. Check this option if the LAN IP address and local DHCP server should remain unchanged after the VPN is up.</p> <p>If you choose not to preserve LAN settings when the VPN is connected, the device will not act as a router, and most Layer 3 routing functions will cease to work.</p>

WAN Connection Priority	
<p>WAN Connection Priority</p>	<p>You can specify the priority of the WAN connections to be used for making VPN connections. WAN connections set to OFF will never be used. Only available WAN connections with the highest priority will be utilized.</p>

User Manual

PEPWAVE *MAX* mobile router

10.2 Link Failure Detection

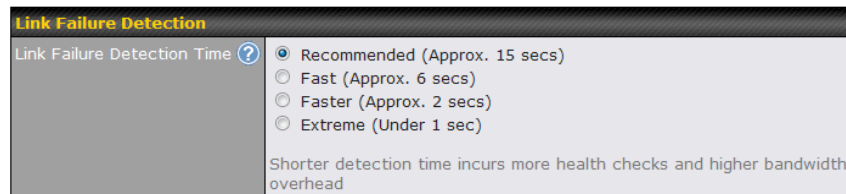

Link Failure Detection

Link Failure Detection Time

The bonded SpeedFusion™ can detect routing failures on the path between two sites over each WAN connection. Failed WAN connections will not be used to route VPN traffic. Health check packets are sent to the remote unit to detect any failure. The more frequent checks it sends, the shorter detection time, but the higher bandwidth overhead will be consumed.

When **Recommended** is selected, a health check packet is sent out every 5 seconds, and the expected detection time is 15 seconds.

When **Fast** is selected, a health check packet is sent out every 3 seconds, and the expected detection time is 6 seconds.

When **Faster** is selected, a health check packet is sent out every 1 second, and the expected detection time is 2 seconds.

When **Extreme** is selected, a health check packet is sent out every 0.1 second, and the expected detection time is under 1 second.

By default, **Recommended** is selected.

Important Note

Pepwave proprietary SpeedFusion™ used TCP port 32015 and UDP port 4500 for establishing VPN connections. If you have a firewall in front of the devices, you will need to add firewall rules for these port and protocols which will allow inbound and outbound traffic pass-through the firewall.

Tip

Want to know more about VPN Sub-Second Session Failover? Visit our [YouTube Channel](http://www.youtube.com/watch?v=TLQgdpPSY88) for a video tutorial!

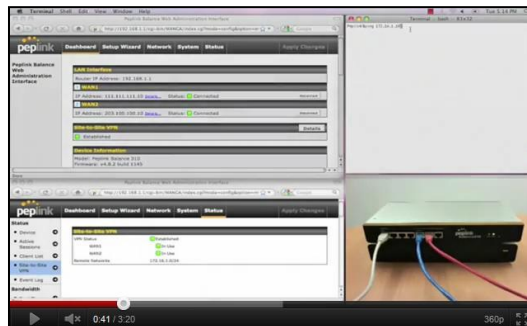

<http://youtu.be/TLQgdpPSY88>

User Manual

PEPWAVE *MAX* mobile router

10.3 Pepwave MAX Behind NAT Router

The Pepwave MAX supports establishing SpeedFusion™ over WAN connections which are behind a NAT (Network Address Translation) router.

To be able for a WAN connection behind a NAT router to accept VPN connections, you can configure the NAT router in front of the WAN connection to forward TCP port 32015 to it.

If one or more WAN connections on **Unit A** can accept VPN connections (by means of port forwarding or not) while none of the WAN connections on the peer **Unit B** can do so, you should put all public IP addresses or host names of the **Unit A** to the **Unit B's Remote IP Addresses / Host Names** field. Leave the field in **Unit A** blank. With such setting, SpeedFusion™ connection can be set up and all WAN connections on both sides will be utilized.

For example, see the following diagram:

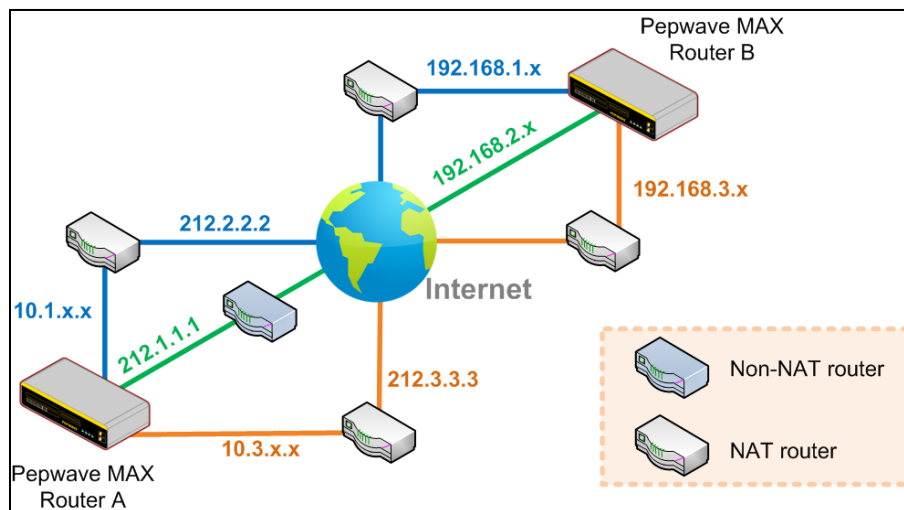

One of the WANs of Router A is non-NAT'd (212.1.1.1). The rest of the WANs on Router A and all WANs on Router B are NAT'd. In such case, the **Remote IP Addresses / Host Names** field in Router B should be filled with all of the Router A's host names or public IP addresses (i.e. 212.1.1.1, 212.2.2.2 and 212.3.3.3), and the field in Router A can be left blank. The two NAT routers on WAN1 and WAN3 of Router A should inbound port forward TCP port 32015 to the Router A so that all WANs would be utilized to establish VPN.

User Manual

PEPWAVE *MAX* mobile router

10.4 SpeedFusion™ Status

VPN Status is shown in the **Status > SpeedFusion™**. The connection status of each connection profile is shown as below:

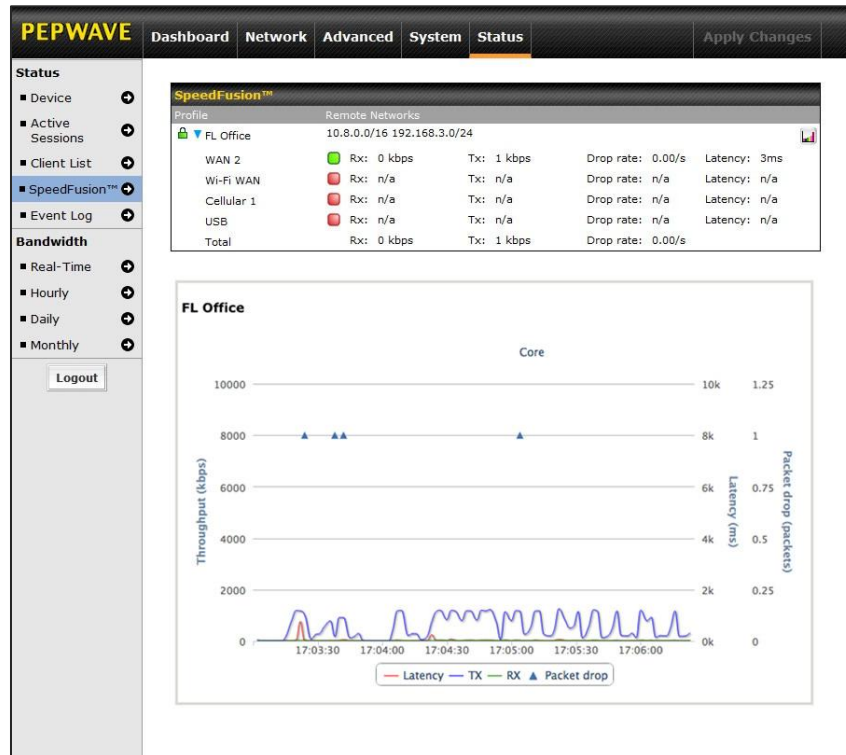

By clicking the **Details** button at the top-right hand corner of SpeedFusion™ table, you will be forwarded to **Status > SpeedFusion™**. You can view the subnet and WAN connection information of each VPN peer. Please refer to Section 19.5 for details.

IP subnets must be unique among VPN peers

The entire inter-connected SpeedFusion™ network is one single non-NAT IP network. No two subnets in two sites shall be duplicated. Otherwise, connectivity problems will be experienced in accessing those subnets.

User Manual

PEPWAVE *MAX* mobile router

11 IPsec VPN

Pepwave MAX IPsec VPN functionality securely connects one or more branch offices to your company's main headquarters or to other branches. The data, voice, or video communications between these locations are thus kept safe and confidential across the public Internet.

The IPsec VPN of the Pepwave MAX is especially designed for a multi-WAN environment. For instance, a user sets up multiple IPsec profiles for his multi-WAN1 ~ WAN3 environment, if WAN1 is connected and its health check turns up good, the IPsec traffic will go through this link. However, should unforeseen problems (e.g. physically unplugged or ISP problems) arise and cause WAN1 to go down, our IPsec implementation will make use of WAN2 and WAN3 accordingly, as failover purposes.

11.1 IPsec VPN Settings

All of our Pepwave products can make multiple IPsec VPN connections with Peplink, Pepwave as well as Cisco or Juniper Routers.

Note that all LAN subnet and subnets behind it have to be unique. Otherwise, VPN members will not be able to access each other.

All data can be routed over the VPN with a selection of encryption standards such as 3DES, AES-128 and AES-256.

To configure, navigate to **Advanced > IPsec VPN:**



IPsec VPN Profiles	Remote Networks	
bzz-bzz	192.168.11.193/28	X
<input type="button" value="New Connection"/>		

A **NAT-Traversal** option and list of defined **IPsec VPN** profiles will be shown.

The NAT-Traversal option should be enabled if your system is behind a NAT router.

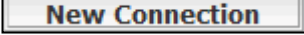
Click the **New Connection** button  to create new IPsec VPN profiles that make VPN connections to remote Peplink Balance, Pepwave MAX, Cisco or Juniper Routers via the available WAN connections. To edit any of the profiles, click on its associated connection name in the leftmost column.

User Manual

PEPWAVE *MAX* mobile router

IPsec VPN Profile											
Name	bzz-bzz										
Active	<input checked="" type="checkbox"/>										
Remote Gateway IP Address	11.22.33.44										
Local Networks	<input checked="" type="checkbox"/> 10.0.0.1/24										
Remote Networks	<table border="1"> <thead> <tr> <th>Network</th> <th>Subnet Mask</th> <th></th> </tr> </thead> <tbody> <tr> <td>192.168.11.193</td> <td>255.255.255.240 (/28)</td> <td><input checked="" type="checkbox"/></td> </tr> <tr> <td></td> <td>255.255.255.0 (/24)</td> <td><input type="checkbox"/></td> </tr> </tbody> </table>	Network	Subnet Mask		192.168.11.193	255.255.255.240 (/28)	<input checked="" type="checkbox"/>		255.255.255.0 (/24)	<input type="checkbox"/>	
Network	Subnet Mask										
192.168.11.193	255.255.255.240 (/28)	<input checked="" type="checkbox"/>									
	255.255.255.0 (/24)	<input type="checkbox"/>									
Mode	<input checked="" type="radio"/> Main Mode (All WANs need to have Static IP) <input type="radio"/> Aggressive Mode										
Force UDP Encapsulation	<input type="checkbox"/>										
Preshared Key <input checked="" type="checkbox"/> Hide Characters										
Local ID											
Remote ID											
Phase 1 (IKE) Proposal	1. 3DES & MD5 2. -----										
Phase 1 DH Group	<input checked="" type="checkbox"/> Group 2: MODP 1024 <input type="checkbox"/> Group 5: MODP 1536										
Phase 1 SA Lifetime	3600 seconds Default										
Phase 2 (ESP) Proposal	1. 3DES & MD5 2. -----										
Phase 2 PFS Group	<input checked="" type="radio"/> None <input type="radio"/> Group 2: MODP 1024 <input type="radio"/> Group 5: MODP 1536										
Phase 2 SA Lifetime	28800 seconds Default										

IPsec VPN Settings	
Name	This field is for specifying a local name to represent this connection profile.
Active	When this box is checked, this IPsec VPN connection profile will be enabled. Otherwise, it will be disabled.
Remote Gateway IP Address	Enter the remote peer's public IP address. For Aggressive Mode, this is optional..
Local Networks	Enter the local LAN subnets here. If you have defined "static routes", they will be shown here too.
Remote Networks	Enter the LAN and subnets that are located at the remote site here.
Main Mode	Choose this Main Mode if both IPsec peers use static IP addresses.
Aggressive Mode	Choose this Aggressive Mode if one of the IPsec peers use dynamic IP addresses.
Force UDP Encapsulation	For UDP encapsulation to be forced regardless of the NAT-Traversal, tick this checkbox.
Pre-shared Key	This defines the peer authentication pre-shared key to be used to authenticate this VPN connection. The connection will be up only if the pre-shared keys on each side match.

User Manual

PEPWAVE *MAX* mobile router

Local ID	<p>Under Main Mode, this field can be left blank.</p> <p>Under Aggressive Mode, if Remote Gateway IP Address field is filled on this end and the peer end, this field can be left blank. Otherwise, this field is typically a U-FQDN.</p>
Remote ID	<p>Under Main Mode, this field can be left blank.</p> <p>Under Aggressive Mode, if Remote Gateway IP Address field is filled on this end and the peer end, this field can be left blank. Otherwise, this field is typically a U-FQDN.</p>
Phase 1 (IKE) Proposal	<p>Under Main Mode, this allows the setting of up to 6 encryption standards, in descending order of priority, to be used in the initial connection key negotiations.</p> <p>For Aggressive Mode, only one selection is permitted.</p>
Phase 1 DH Group	<p>This is the Diffie-Hellman group used within IKE. This allows two parties to establish a shared secret over an insecure communications channel. The larger the group number, the higher the security.</p> <p>Group 2 - 1024-bit is the default value.</p> <p>Group 5 - 1536-bit is the alternative option.</p>
Phase 1 SA Lifetime	<p>This setting specifies the lifetime limit of this Phase 1 Security Association. By default, it is set at 3600 seconds.</p>
Phase 2 (ESP) Proposal	<p>Under Main Mode, this allows the setting of up to 6 encryption standards, in descending order of priority, to be used for the IP data that is being transferred.</p> <p>For Aggressive Mode, only one selection is permitted.</p>
Phase 2 PFS Group	<p>The Perfect Forward Secrecy (PFS) ensures that if a key was compromised, the attacker will be able to access only the data protected by that key but not any other data.</p> <p>None - Do not request for PFS when initiating connection. However, since there is no valid reason to refuse PFS, the system will allow the connection to use PFS if requested by the remote peer. This is the default value.</p> <p>Group 2 - 1024-bit Diffie-Hellman group. The larger the group number, the higher the security.</p> <p>Group 5 - 1536-bit is the third option.</p>
Phase 2 SA Lifetime	<p>This setting specifies the lifetime limit of this Phase 2 Security Association. By default, it is set at 28800 seconds.</p>

WAN Connection Priority

WAN Connection Select the appropriate WAN connection with the help of drop down

WAN Connection Priority	
Priority	WAN Selection
1	WAN 1
2	----

User Manual

PEPWAVE *MAX* mobile router

11.2 IPsec Status

IPsec Status shows the current connection status of each connection profile and is displayed in **Status > IPsec**.

12 Management of Outbound Traffic to WAN

Pepwave MAX provides the functionality to flexibly manage and load balance outbound traffic among the WAN connections.

Important Note

Outbound Policy is applied only when more than one WAN connection is active.

The settings for managing and load balancing outbound traffic are located in **Advanced > Outbound Policy**.



Network > Outbound Policy > Click on 

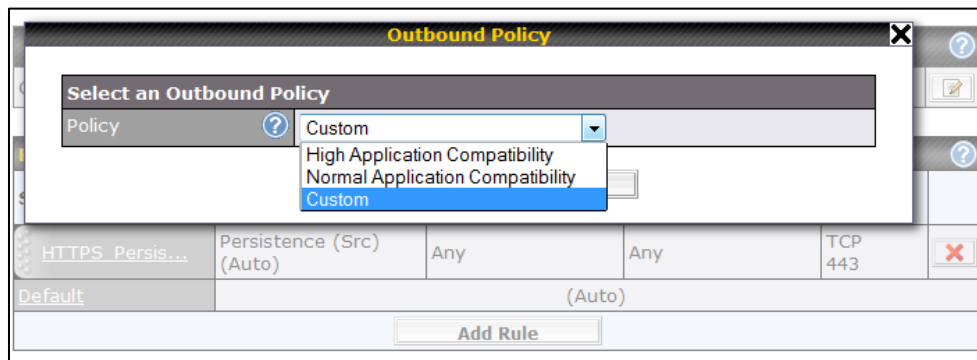

12.1 Outbound Policy

There are three main selections for the Outbound Policy for Pepwave MAX:

- High Application Compatibility
- Normal Application Compatibility
- Custom

The selections are explained as follows:

User Manual

PEPWAVE *MAX* mobile router

Outbound Policy Settings

High Application Compatibility	<p>With the selection of this policy, outbound traffic from a source LAN device is routed through the same WAN connection regardless of the destination Internet IP address and protocol.</p> <p>This provides the highest application compatibility.</p>
Normal Application Compatibility	<p>With the selection of this policy, outbound traffic from a source LAN device to the same destination Internet IP address will persistently be routed through the same WAN connection regardless of protocol.</p> <p>This provides high compatibility to most applications, and users still benefit from WAN link load balancing when multiple Internet servers are accessed.</p>
Custom	<p>With the selection of this policy, outbound traffic behavior can be managed by defining custom rules.</p> <p>Rules can be defined in a custom rule table. A default rule can be defined for connections that cannot be matched with any one of the rules.</p>

The default policy is **Normal Application Compatibility**.

Tip

Want to know more about how-to create outbound rules? Visit our [YouTube Channel](#) for a video tutorial!

The screenshot shows the PEPWAVE web interface. The top navigation bar includes 'Dashboard', 'Network', 'Advanced', 'System', and 'Status'. The 'Advanced' section is expanded, showing various settings like 'Wi-Fi Settings', 'SpeedFusion™', 'IPsec VPN', 'Outbound Policy', 'Port Forwarding', 'NAT Mappings', 'QoS', 'User Groups', 'Bandwidth Control', 'Application', 'Firewall', and 'Misc. Settings'. The 'Outbound Policy' is set to 'Custom'. Below this, there is a table of rules with columns for 'Service', 'Algorithm', 'Source', 'Destination', and 'Protocol / Port'. A 'Default' rule is listed at the bottom of the table.

Service	Algorithm	Source	Destination	Protocol / Port
HTTPS_Persis...	Persistence (Src) (Auto)	Any	Any	TCP 443
Default			(Auto)	

http://youtu.be/rKH4AS_bQnE

12.2 Custom Rules For Outbound Policy

Click  in the Outbound Policy form. Choose **Managed by Custom Rules** and press the **Save** button. The following screen will then be displayed.

The bottom-most rule is **Default**. Edit this rule to change the device's default way to control outbound traffic for all connections that does not match any rules above it. Click on the service name **Default** to change its settings.

User Manual

PEPWAVE *MAX* mobile router

Outbound Policy ?

Custom 

Rules  Drag and drop rows to change rule order) ?

Service	Algorithm	Source	Destination	Protocol / Port	
HTTPS Persis...	Persistence (Src) (Auto)	Any	Any	TCP 443	
Default	(Auto)				

Add Rule

Edit Default Custom Rule X

Default Rule

Default Rule ? Custom Auto

Algorithm ? Weighted Balance ▾

Load Distribution Weight ?

Ethernet WAN 10 

PC Card 10 

Express Card 10 

USB1 10 

USB2 10 

Wi-Fi WAN 10 

Terminate Sessions on Link Recovery ? Enable

Save **Cancel**

You may drag and drop a row to rearrange the priority of outbound rules.

Outbound Policy ?

Managed by Custom Rules 

Custom Rules  Drag and drop rows to change rule order) ?

Service	Algorithm	Source	Destination	Protocol / Port	
HTTPS Persis...	Persistence (Auto)	Any	Any	TCP 443	
Default	(Auto)				

Add Rule

User Manual

PEPWAVE *MAX* mobile router

HTTPS_Persistence	
Service Name *	HTTPS_Persistence
Enable	<input checked="" type="checkbox"/>
Source	Any
Destination	Any
Protocol	TCP
Port *	Single Port Port: 443
Algorithm	Persistence
Persistence Mode	<input checked="" type="radio"/> By Source <input type="radio"/> By Destination
Load Distribution	<input checked="" type="radio"/> Auto <input type="radio"/> Custom
Terminate Sessions on Link Recovery	<input type="checkbox"/> Enable

By default, **Auto** is selected for the option **Default Rule**. You can select **Custom** in order to change the Algorithm to be used. Please refer to the upcoming sections for the details of the available algorithms.

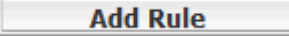
To create a custom rule, click **Add Rule**  at the bottom of the table, and the following window will be displayed:

New Custom Rule	
Service Name *	
Enable	<input checked="" type="radio"/> Yes <input type="radio"/> No
Source	IP Network Mask: 255.255.255.0
Destination	IP Network Mask: 255.255.255.0
Protocol	TCP
Port *	Any Port
Algorithm	Weighted Balance
Load Distribution Weight	Ethernet WAN 10 Express Card 10 PC Card 10 USB1 10 USB2 10 Wi-Fi WAN 10
Terminate Sessions on Link Recovery	<input type="checkbox"/> Enable

If Domain Name is chosen and a domain name, such as foobar.com, is entered, any outgoing accesses to foobar.com and *.foobar.com will match this criterion. You may enter a wildcard (.*) at the end of a domain name to match any host with a name having the domain name in the middle. If you enter foobar.*, for example, then www.foobar.com, www.foobar.co.jp, or foobar.co.uk will also match. Placing wildcards in any other position is not supported.

NOTE: If a server has one Internet IP address and multiple server names, and if one of the names is defined here, then accesses to any one of the server names will also match this rule.

User Manual

PEPWAVE *MAX* mobile router

New Custom Rule Settings

Service Name This setting specifies the name of the custom rule.

Enable This setting specifies whether the outbound traffic rule takes effect.
 With an Enable value of **Yes**, the rule takes effect: traffic is matched, and actions are taken, by Pepwave MAX based on the other parameters of the rule.
 With an Enable value of **No**, the rule does not take effect Pepwave MAX disregards the other parameters of the rule.

Source This setting specifies the source IP Address, IP Network or MAC Address for outbound traffic that matches the rule.

Destination This setting specifies the destination IP Address or IP Network or Domain Name for traffic that matches the rule.

Domain Name If Domain Name is chosen and a domain name, such as foobar.com, is entered, any outgoing accesses to foobar.com and *.foobar.com will match this criterion. You may enter a wildcard (.*) at the end of a domain name to match any host with a name having the domain name in the middle. If you enter .*, for example, then www.foobar.com, www.foobar.co.jp, or foobar.co.uk will also match. Placing wildcards in any other position is not supported.

NOTE: if a server has one Internet IP address and multiple server names, and if one of the names is defined here, then accesses to any one of the server names will also match this rule.

Protocol and Port This setting specifies the IP Protocol and Port of outbound traffic that matches this rule. You may select some common protocol from the **Protocol Selection Tool** drop-down menu.

User Manual

PEPWAVE *MAX* mobile router

Algorithm

This setting specifies the behavior of Pepwave MAX for the custom rule. One of the following values can be selected:

- Weighted Balance
- Persistence
- Enforced
- Priority
- Overflow
- Least Used
- Lowest Latency

The upcoming sections present the details of the listed algorithms.

Terminate Sessions on Link Recovery

This setting specifies whether to terminate existing IP sessions on a less preferred WAN connection in the event that a more preferred WAN connection is recovered. This setting is applicable to the Algorithms: **Weighted**, **Persistence** and **Priority**.

By default, this is disabled. In this case, all existing IP sessions will not be terminated or affected when any other WAN connection is recovered. If it is set to enabled, existing IP sessions may be terminated when another WAN connection is recovered such that only the preferred healthy WAN connection(s) are used at any point in time.

12.2.1 Algorithm: Weighted Balance

This setting specifies the ratio of WAN connection usage to be applied on the specified IP Protocol & Port, and is applicable only when Algorithm is set to **Weighted Balance**.

Algorithm	<input type="text" value="Weighted Balance"/>
Load Distribution Weight	<p>WAN 1 10</p> <p>WAN 2 10</p> <p>Wi-Fi WAN 10</p> <p>Cellular 1 10</p> <p>Cellular 2 10</p> <p>USB 10</p>
Terminate Sessions on Link Recovery	<input type="checkbox"/> Enable
<p>Save Cancel</p>	

The amount of matching traffic that is distributed to a WAN connection is proportional to the weight of the WAN connection relative to the total weight. Use the sliders to change the weight for each WAN.

Example: With the following weight settings:

- Ethernet WAN1: 10
- Ethernet WAN2: 10
- Wi-Fi WAN: 10
- Cellular 1: 10
- Cellular 2: 10
- USB: 10

User Manual

PEPWAVE *MAX* mobile router

Total weight is 60 = (10 + 10 + 10 + 10 + 10 + 10)

Matching traffic distributed to Ethernet WAN1 is 16.7% = (10 / 60) x 100%

Matching traffic distributed to Ethernet WAN2 is 16.7% = (10 / 60) x 100%

Matching traffic distributed to Wi-Fi WAN is 16.7% = (10 / 60) x 100%

Matching traffic distributed to Cellular 1 is 16.7% = (10 / 60) x 100%

Matching traffic distributed to Cellular 2 is 16.7% = (10 / 60) x 100%

Matching traffic distributed to USB is 16.7% = (10 / 60) x 100%

User Manual

PEPWAVE *MAX* mobile router

12.2.2 Algorithm: Persistence

The configuration of using Persistence for algorithm is the solution to the few situations where link load distribution for Internet services is undesirable.

For example, many e-banking and other secure websites, for security reasons, terminate the session when the client computer's Internet IP address changes during the session.

In general, different Internet IP addresses represent different computers. The security concern is that an IP address change during a session may be the result of an unauthorized intrusion attempt. Therefore, to prevent damages from the potential intrusion, the session is terminated upon the detection of an IP address change.

Pepwave MAX can be configured to distribute data traffic across multiple WAN connections. Also, the Internet IP depends on the WAN connections over which communication actually takes place. As a result, a LAN client computer behind Pepwave MAX may communicate using multiple Internet IP addresses. For example, a LAN client computer behind a Pepwave MAX with three WAN connections may communicate on the Internet using three different IP addresses.

With the algorithm Persistence of Pepwave MAX, rules can be configured to enable client computers to persistently utilize the same WAN connections for e-banking and other secure websites. As a result, a client computer will communicate with the other end using one IP address and eliminate the issues.

Algorithm	<input type="text" value="Persistence"/>
Persistence Mode	<input type="radio"/> By Source <input checked="" type="radio"/> By Destination
Load Distribution	<input checked="" type="radio"/> Auto <input type="radio"/> Custom
Terminate Sessions on Link Recovery	<input type="checkbox"/> Enable
<input type="button" value="Save"/> <input type="button" value="Cancel"/>	

There are two modes for Persistence: **By Source** and **By Destination**.

By Source	The same WAN connection will be used for traffic matching the rule and originating from the same machine regardless of its destination. This option will provide the highest level of application compatibility.
By Destination	The same WAN connection will be used for traffic matching the rule, originating from the same machine, and going to the same destination. This option can better distribute load to WAN connections when there are only a few client machines.

The default mode is **By Source**.

When there are multiple client requests, they can be distributed (persistently) to WAN connections with a weight. If you choose **Auto** for **Load Distribution**, the weights will be automatically adjusted according to each WAN's Downstream Bandwidth which is specified in the WAN settings page (see Section 8 Configuration of WAN Interface(s)). If you choose **Custom**, you can customize the weight of each WAN manually by using the sliders.

User Manual

PEPWAVE *MAX* mobile router

12.2.3 Algorithm: Enforced

This setting specifies the WAN connection usage to be applied on the specified IP Protocol & Port, and is applicable only when the Algorithm is set to **Enforced**.

Algorithm	Enforced
Enforced Connection	WAN: WAN 1
	WAN: WAN 1
	WAN: WAN 2
	WAN: Wi-Fi WAN
	WAN: Cellular 1
	WAN: Cellular 2
	WAN: USB
	VPN: FL Office

Matching traffic will be routed through the specified WAN connection regardless of the connection's health check status.

Starting from firmware 5.2, outbound traffic can be enforced to go through a specified SpeedFusion™ connection.

12.2.4 Algorithm: Priority

This setting specifies the priority of the WAN connections to be utilized to route the specified network service. The highest priority WAN connection available will always be used for routing the specified type of traffic. A lower priority WAN connection will be used only when all higher priority connections have become unavailable.

Algorithm	Priority	
Priority Order	Highest Priority	Not In Use
	WAN: WAN 1	VPN: FL Office
	WAN: WAN 2	
	WAN: Wi-Fi WAN	
	WAN: Cellular 1	
	WAN: Cellular 2	
	WAN: USB	
	Lowest Priority	
Terminate Sessions on Link Recovery	<input type="checkbox"/> Enable	

Starting from firmware 5.2, outbound traffic can be prioritized to go through SpeedFusion™ connection(s). By default, VPN connections are not included in the priority list.

Tip

Configure multiple distribution rules to accommodate different kinds of services.

User Manual

PEPWAVE *MAX* mobile router

12.2.5 Algorithm: Overflow

The traffic matching this rule will be routed through the healthy WAN connection that has the highest priority and is not in full load. When this connection gets saturated, new sessions will be routed to the next healthy WAN connection that is not in full load.

Algorithm	<input type="text" value="Overflow"/>								
Overflow Order	<table border="1"><tr><td>Highest Priority</td></tr><tr><td>WAN 1</td></tr><tr><td>WAN 2</td></tr><tr><td>Wi-Fi WAN</td></tr><tr><td>Cellular 1</td></tr><tr><td>Cellular 2</td></tr><tr><td>USB</td></tr><tr><td>Lowest Priority</td></tr></table>	Highest Priority	WAN 1	WAN 2	Wi-Fi WAN	Cellular 1	Cellular 2	USB	Lowest Priority
Highest Priority									
WAN 1									
WAN 2									
Wi-Fi WAN									
Cellular 1									
Cellular 2									
USB									
Lowest Priority									
<input type="button" value="Save"/> <input type="button" value="Cancel"/>									

Drag and drop to specify the order of WAN connections to be used for routing traffic. Only the highest priority healthy connection that is not in full load will be utilized.

12.2.6 Algorithm: Least Used

Algorithm	<input type="text" value="Least Used"/>
Connection	<input checked="" type="checkbox"/> WAN 1 <input checked="" type="checkbox"/> WAN 2 <input checked="" type="checkbox"/> Wi-Fi WAN <input checked="" type="checkbox"/> Cellular 1 <input checked="" type="checkbox"/> Cellular 2 <input checked="" type="checkbox"/> USB
<input type="button" value="Save"/> <input type="button" value="Cancel"/>	

The traffic matching this rule will be routed through the healthy WAN connection that is selected in the field **Connection** and has the most available downstream bandwidth. The available downstream bandwidth of a WAN connection is calculated from the total downstream bandwidth specified in the WAN settings page and the current downstream usage. The available bandwidth and WAN selection is determined every time when an IP session is made.

12.2.7 Algorithm: Lowest Latency

Algorithm	<input type="text" value="Lowest Latency"/> <small>Note: Use of Lowest Latency will incur additional network usage.</small>
Connection	<input checked="" type="checkbox"/> WAN 1 <input checked="" type="checkbox"/> WAN 2 <input checked="" type="checkbox"/> Wi-Fi WAN <input checked="" type="checkbox"/> Cellular 1 <input checked="" type="checkbox"/> Cellular 2 <input checked="" type="checkbox"/> USB
<input type="button" value="Save"/> <input type="button" value="Cancel"/>	

User Manual

PEPWAVE *MAX* mobile router

The traffic matching this rule will be routed through the healthy WAN connection that is selected in the field *Connection* and has the lowest latency. Latency checking packets are issued periodically to a nearby router of each WAN connection to determine its latency value. The latency of a WAN is the packet round trip time of the WAN connection. Additional network usage may be incurred as a result.

Tip

The round trip time of a “6M down / 640k up” link can be higher than that of a “2M down / 2M up” link. It is because the overall round trip time is lengthened by its lower upstream bandwidth despite of its higher downlink speed. Therefore this algorithm is good for two scenarios:

- All WAN connections are symmetric; or
- A latency sensitive application requires to be routed through the lowest latency WAN regardless the WAN's available bandwidth.

12.2.8 Expert Mode

Expert Mode is also available for advance users. Click the help test balloon and click the link turn on Expert Mode to switch on the feature.

Under Expert Mode, a special rule - "SpeedFusion™ Routes" is displayed on the Custom Rules table. It represents all SpeedFusion™ routes learned from remote VPN peers. By default, this bar is on the top of all custom rules. That means traffic for remote VPN subnets will be routed to its corresponding VPN peer. You can create custom Priority or Enforced rules and move them above the bar to override the SpeedFusion™ Routes.

Upon disabling the Expert Mode, all rules above the bar will be deleted.

Service	Algorithm	Source	Destination	Protocol / Port	
HTTPS_Persis...	Persistence (Src) (Auto)	Any	Any	TCP 443	X
Default		(Auto)			
<input type="button" value="Add Rule"/>					

Help Close

This table allows you to fine tune how the outbound traffic should be distributed to the WAN connections.

Click the *Add Rule* button to add a new rule. Click the *X* button to remove a rule. Drag a rule to promote or demote its precedence. A higher position of a rule signifies a higher precedence. You may change the default outbound policy behavior by clicking the *Default* link.

If you require advanced control of S2S VPN traffic, [turn on Expert Mode](#).

13 Port Forwarding

13.1 Port Forwarding Service

Pepwave MAX can act as a firewall that blocks, by default, all inbound access from the Internet. By using **Port Forwarding**, Internet users can access the servers behind Pepwave MAX.

Inbound Port Forwarding rules can be defined at **Advanced > Port Forwarding**:

Service	IP Address(es)	Server	Protocol	Action
Web	Ethernet WAN: default	192.168.1.10	TCP:80	Delete
Add Service				

To define a new service, click the **Add Service** button, upon which the following appears:

Enable	<input checked="" type="radio"/> Yes <input type="radio"/> No																												
Service Name *	<input type="text"/>																												
IP Protocol	TCP <input type="button" value="←"/> :: Protocol Selection Tool :: <input type="button" value="→"/>																												
Port	Any Port																												
Inbound IP Address(es) * <small>(Require at least one IP address)</small>	<table border="1"> <thead> <tr> <th colspan="2">Connection / IP Address(es)</th> <th>All</th> <th>Clear</th> </tr> </thead> <tbody> <tr> <td><input type="checkbox"/></td> <td>WAN 1</td> <td></td> <td></td> </tr> <tr> <td><input type="checkbox"/></td> <td>WAN 2</td> <td></td> <td></td> </tr> <tr> <td><input type="checkbox"/></td> <td>Wi-Fi WAN</td> <td></td> <td></td> </tr> <tr> <td><input type="checkbox"/></td> <td>Cellular 1</td> <td></td> <td></td> </tr> <tr> <td><input type="checkbox"/></td> <td>Cellular 2</td> <td></td> <td></td> </tr> <tr> <td><input type="checkbox"/></td> <td>USB</td> <td></td> <td></td> </tr> </tbody> </table>	Connection / IP Address(es)		All	Clear	<input type="checkbox"/>	WAN 1			<input type="checkbox"/>	WAN 2			<input type="checkbox"/>	Wi-Fi WAN			<input type="checkbox"/>	Cellular 1			<input type="checkbox"/>	Cellular 2			<input type="checkbox"/>	USB		
Connection / IP Address(es)		All	Clear																										
<input type="checkbox"/>	WAN 1																												
<input type="checkbox"/>	WAN 2																												
<input type="checkbox"/>	Wi-Fi WAN																												
<input type="checkbox"/>	Cellular 1																												
<input type="checkbox"/>	Cellular 2																												
<input type="checkbox"/>	USB																												
Server IP Address	<input type="text"/>																												
* Required Fields																													
<input type="button" value="Save"/> <input type="button" value="Cancel"/>																													

Port Forwarding Settings	
Enable	<p>This setting specifies whether the inbound service rule takes effect.</p> <p>When Yes is selected, the inbound service rule takes effect. If the inbound traffic matches the specified IP Protocol and Port, action will be taken by Pepwave MAX based on the other parameters of the rule.</p> <p>When No is selected, the inbound service rule does not take effect. Pepwave MAX will disregard the other parameters of the rule.</p>
Service Name	<p>This setting identifies the service to the System Administrator.</p> <p>Valid values for this setting consist only of alphanumeric and the underscore “_” characters.</p>
IP Protocol	<p>The IP Protocol setting, along with the Port setting, specifies the protocol of the service as TCP, UDP, ICMP or IP.</p> <p>Traffic that is received by Pepwave MAX via the specified protocol at the specified port(s) is forwarded to the LAN hosts specified by the Servers setting.</p> <p>(Please see below for details on the Port and Servers settings.)</p> <p>Alternatively, the Protocol Selection Tool drop-down menu can be used to automatically fill in the Protocol and a single Port number of common Internet services (e.g. HTTP,</p>

User Manual

PEPWAVE *MAX* mobile router

HTTPS, etc.).

After selecting an item from the Protocol Selection Tool drop-down menu, the Protocol and Port number remains manually modifiable.

The Port setting specifies the port(s) that correspond to the service, and can be configured to behave in one of the following manners:

Any Port, Single Port, Port Range and Port Map

Port		Any Port	▼
------	---	----------	---

Any Port: All traffic that is received by Pepwave MAX via the specified protocol is forwarded to the servers specified by the Servers setting.

For example, with IP Protocol set to TCP, and Port set to Any Port, all TCP traffic is forwarded to the configured servers.

Port		Single Port	▼	Service Port:	<input type="text"/>
------	---	-------------	---	---------------	----------------------

Single Port: Traffic that is received by Pepwave MAX via the specified protocol at the specified port is forwarded via the same port to the servers specified by the Servers setting.

For example, with IP Protocol set to TCP, and Port set to **Single Port** and **Service Port 80**, TCP traffic received on Port 80 is forwarded to the configured servers via Port 80.

Port		Port Range	▼	Service Ports:	<input type="text"/> - <input type="text"/>
------	---	------------	---	----------------	---

Port Range: Traffic that is received by Pepwave MAX via the specified protocol at the specified port range is forwarded via the same respective ports to the LAN hosts specified by the Servers setting.

For example, with IP Protocol set to TCP, and Port set to **Single Port** and **Service Port 80-88**, TCP traffic received on ports 80 through 88 is forwarded to the configured servers via the respective ports.

Port		Port Mapping	▼	Service Port:	<input type="text"/>	Map to Port:	<input type="text"/>
------	---	--------------	---	---------------	----------------------	--------------	----------------------

Port Mapping: Traffic that is received by Pepwave MAX via the specified protocol at the specified port is forwarded via a different port to the servers specified by the Servers setting.

For example, with IP Protocol set to TCP, and Port set to **Port Map**, **Service Port 80**, and **Map to Port 88**, TCP traffic on Port 80 is forwarded to the configured servers via Port 88. (Please see below for details on the Servers setting.)

Port		Range Mapping	▼	Service Ports:	<input type="text"/> - <input type="text"/>	Map to Ports:	<input type="text"/> - <input type="text"/>
------	---	---------------	---	----------------	---	---------------	---

Range Mapping: traffic that is received by Pepwave MAX via the specified protocol at the specified port range is forwarded via a different port to the servers specified by the Servers setting.

Port

Inbound IP Address(es)

This setting specifies the WAN connections and Internet IP address(es) from which the service can be accessed.

It is required to select at least one IP address.

Server IP Address

This setting specifies the LAN IP address of the server that handles the requests for the service.

User Manual

PEPWAVE *MAX* mobile router

13.2 UPnP / NAT-PMP Settings

UPnP and NAT-PMP are network protocols which allow a computer on the LAN to automatically configure the router to allow parties on the WAN to connect to itself. In this way, the process of inbound port forwarding is automated.

When a computer creates a rule using these protocols, the specified TCP/UDP port of all WAN connections' default IP address will be forwarded.

Check the corresponding box(es) to enable UPnP and/or NAT-PMP. Enable these features only if you trust the computers on the LAN.

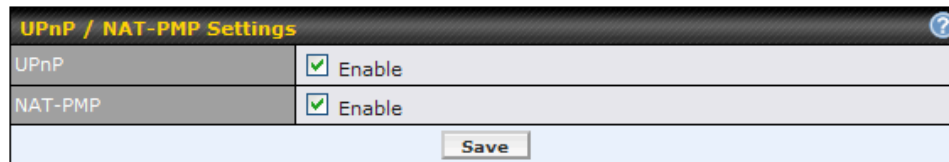

UPnP / NAT-PMP Settings	
UPnP	<input checked="" type="checkbox"/> Enable
NAT-PMP	<input checked="" type="checkbox"/> Enable
<input type="button" value="Save"/>	

A table listing all the forwarded ports under these two protocols can be found at **Status > UPnP / NAT-PMP**.

14 NAT Mappings

The configuration of NAT Mappings allows the IP address mapping of all inbound and outbound NAT'd traffic to and from an internal client IP address.

The settings to configure NAT Mappings are located at **Advanced > NAT Mappings**:

LAN Host	Inbound Mappings	Outbound Mappings	Action
192.168.1.23	(WAN1):29.123.123.13	(WAN1):29.123.123.13	Delete
192.168.1.24	(WAN2):30.21.21.12	(WAN2):30.21.21.12	Delete

To add a rule for NAT Mappings, click **Add NAT Rule** , upon which the following screen will be displayed:

LAN Client(s)	<input type="text" value="IP Address"/>
Address	<input type="text"/>
Inbound Mappings	Connection / Inbound IP Address(es) <input type="checkbox"/> WAN 1 <input type="checkbox"/> WAN 2 <input type="checkbox"/> Wi-Fi WAN <input type="checkbox"/> Cellular 1 <input type="checkbox"/> Cellular 2 <input type="checkbox"/> USB
Outbound Mappings	Connection / Outbound IP Address WAN 1: 10.9.2.39 (Interface IP) WAN 2: Interface IP Wi-Fi WAN: Interface IP Cellular 1: Interface IP Cellular 2: Interface IP USB: Interface IP

Click **Save** to save the settings when configuration has been completed.

User Manual

PEPWAVE *MAX* mobile router

NAT Mapping Settings

LAN Client(s)	NAT Mapping rules can be defined for a single LAN IP Address , an IP Range , or an IP Network .
Address	This refers to the LAN host's private IP address. The system maps this address to a number of public IP addresses, specified below, in order to facilitate inbound and outbound traffic. This option is only available when IP Address is selected.
Range	The IP range is a contiguous group of private IP addresses used by the LAN host. The system maps these addresses to a number of public IP addresses, specified below, to facilitate outbound traffic. This option is only available when IP Range is selected.
Network	The IP network refers to all private IP addresses and ranges managed by the LAN host. The system maps these addresses to a number of public IP addresses, specified below, to facilitate outbound traffic. This option is only available when IP Network is selected.
Inbound Mappings	This setting specifies the WAN connections and corresponding WAN-specific Internet IP addresses on which the system should bind on. Any access to the specified WAN connection(s) and IP address(es) will be forwarded to the LAN Host. This option is only available when IP Address is selected in LAN Client(s) field. Note 1: Inbound Mapping is not needed for WAN connections in drop-in or IP forwarding mode. Note 2: Each WAN IP address can be associated to one NAT Mapping only.
Outbound Mappings	This setting specifies the WAN IP addresses should be used when an IP connection is made from a LAN host to the Internet. Each LAN host in an IP range or IP network will be evenly mapped to one of each selected WAN's IP addresses (for better IP address utilization) in a persistent manner (for better application compatibility). Note 1: If you do not want to use a specific WAN for outgoing accesses, you should still choose default here, then customize the outbound access rule in the Outbound Policy section. Note 2: WAN connections in drop-in or IP forwarding mode are not shown here.

Important Note

Inbound firewall rules override the Inbound Mapping settings.

User Manual



PEPWAVE *MAX* mobile router

15 QoS

15.1 User Groups

LAN and PPTP clients can be categorized into three user groups - **Manager, Staff, and Guest**. This table allows you to define rules and assign client IP addresses or subnets to a user group. You can apply different bandwidth and traffic prioritization policies on each user group in the Bandwidth Control and Application sections.

The table is automatically sorted, and the table order signifies the rules' precedence. The smaller and more specific subnets are put towards the top of the table and have higher precedence; larger and less specific subnets are placed towards the bottom.

Click the **Add** button  to define clients and their user group. Click the  button to remove the defined rule.

Two default rules are pre-defined and put at the bottommost. They are **All DHCP reservation clients** and **Everyone**, and they cannot be removed. **All DHCP reservation clients** represents the LAN clients defined in the DHCP Reservation table in the LAN settings page. **Everyone** represents all clients that are not defined in any rule above. Click on a rule to change its group.

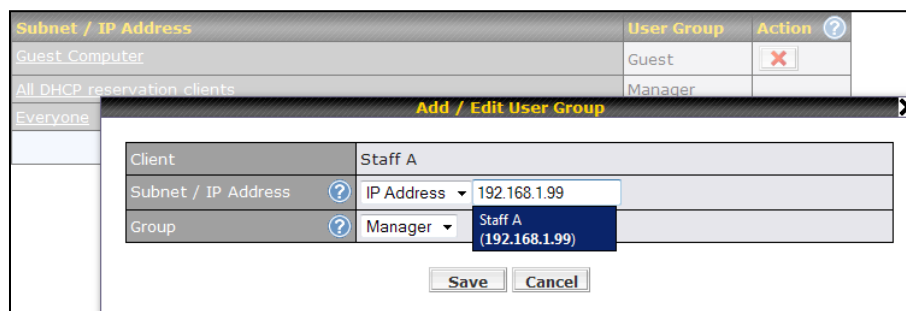

Add / Edit User Group	
Subnet / IP Address	From the drop-down menu, choose whether you are going to define the client(s) by an IP Address or a Subnet . If IP Address is selected, enter a name defined in DHCP Reservation table or a LAN client's IP address. If Subnet is selected, enter a subnet address and specify its subnet mask.
Group	This field is to define which User Group the specified Subnet / IP Address belongs to.

Once users have been assigned to a user group, their Internet traffic will be restricted by rules defined for that particular group. Please refer to the following two sections for details.

User Manual

PEPWAVE *MAX* mobile router

15.2 Bandwidth Control

You can define a maximum download speed (over all WAN connections) and upload speed (for each WAN connection) that each individual Staff and Guest member can consume. No limit can be imposed on individual Manager members.

By default, Download and Upload Bandwidth Limits are set to unlimited (set as **0**).

Individual Bandwidth Limit 					
Enable	<input checked="" type="checkbox"/>				
User Bandwidth Limit	Download		Upload		
	Manager: Unlimited		Unlimited		
	Staff:	0 Mbps	0 Mbps	(0: unlimited)	
	Guest:	0 Mbps	0 Mbps	(0: unlimited)	

User Manual

PEPWAVE *MAX* mobile router

15.3 Application

15.3.1 Application Prioritization

You can choose whether to apply the same Prioritization settings to all user groups or customize the settings for each group.

Application Prioritization

Apply same settings to all users
 Customize

Three priority levels can be set for application prioritization: ↑ **High**, — **Normal**, and ↓ **Low**.

Four types of applications are predefined. Their priority for each user group can be selected from their corresponding drop down menu. Traffic types not defined in the table is assigned with normal priority.

Application	Priority			Action
	Manager	Staff	Guest	
PPTP and IPsec VPN	— Normal	— Normal	— Normal	
SIP/Vonage	↑ High	↑ High	↑ High	
Skype, Google Talk, RealVideo, and Windows Streaming Media	— Normal	— Normal	— Normal	
Secure Web (HTTPS)	— Normal	— Normal	— Normal	
Custom Application				
Testing	↓ Low	↓ Low	↓ Low	
<input type="button" value="Add"/>				

15.3.2 Prioritization for Custom Application

Click the **Add** button to define a custom application. Click the button in the **Action** column to delete the custom application in the corresponding row.

Add / Edit Application ✕

Application Name:

Scope / Protocol:

Port:

Application Prioritization	
PPTP and IPsec VPN	When enabled, any PPTP and IPsec traffic will be prioritized.
SIP/Vonage	When enabled, any SIP and Vonage voice traffic will be prioritized.
Skype, Google Talk, Real Video, and Windows Streaming Media	When enabled, voice and video traffic of Skype, Google Talk, Real Video and Windows Streaming Media will be prioritized.
Secure Web (HTTPS)	When enabled, HTTPS (TCP port 443) traffic will be prioritized.

User Manual

PEPWAVE *MAX* mobile router

15.3.3 DSL/Cable Optimization

DSL/cable-based WAN connection has its upload bandwidth lower than the download bandwidth. When this option is enabled, the download bandwidth of the WAN can be fully utilized in any situation.

When a DSL/cable circuit's uplink is congested, the download bandwidth will be affected. Users will not be able to download data in full speed until the uplink becomes less congested. The DSL/Cable Optimization can relieve such issue. When it is enabled, the download speed will become less affected by the upload traffic.

By default, this feature is **enabled**.

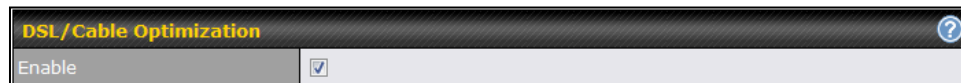

16 Firewall

A firewall is a mechanism that selectively filters data traffic between the WAN side (the Internet) and the LAN side of the network. It can protect the local network from potential hacker attacks, offensive Web sites, and/or other inappropriate uses.

The firewall functionality of Pepwave MAX supports the selective filtering of data traffic in both directions:

- Outbound (LAN to WAN)
- Inbound (WAN to LAN)
- Intrusion Detection and DoS Prevention

With SpeedFusion™ enabled (see Section 10), the firewall rules also apply to VPN tunneled traffic.

16.1 Outbound and Inbound Firewall

16.1.1 Access Rules

The outbound firewall settings are located at: **Advanced > Firewall > Outbound Firewall Rule.**

Outbound Firewall Rules (Drag and drop rows to change rule order)					
Rule	Protocol	Source IP Port	Destination IP Port	Policy	
Default	Any	Any	Any	Allow	
Add Rule					

Upon clicking **Add Rule** , the following screen appears:

Add a New Outbound Firewall Rule ✕

New Firewall Rule	
Rule Name *	<input type="text"/>
Enable	<input checked="" type="checkbox"/>
Protocol	Any ← :: Protocol Selection Tool ::
Source IP & Port	Any Address
Destination IP & Port	Any Address
Action	<input checked="" type="radio"/> Allow <input type="radio"/> Deny
Event Logging	<input type="checkbox"/> Enable

The Inbound firewall settings are located at: **Advanced > Firewall > Inbound Firewall Rule.**

Inbound Firewall Rules (Drag and drop rows to change rule order)					
Rule	Protocol	WAN	Source IP Port	Destination IP Port	Policy
Default	Any	Any	Any	Any	Allow
Add Rule					

User Manual

PEPWAVE *MAX* mobile router

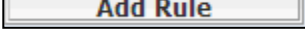
Once you click on **Add Rule**  the following window will appear.

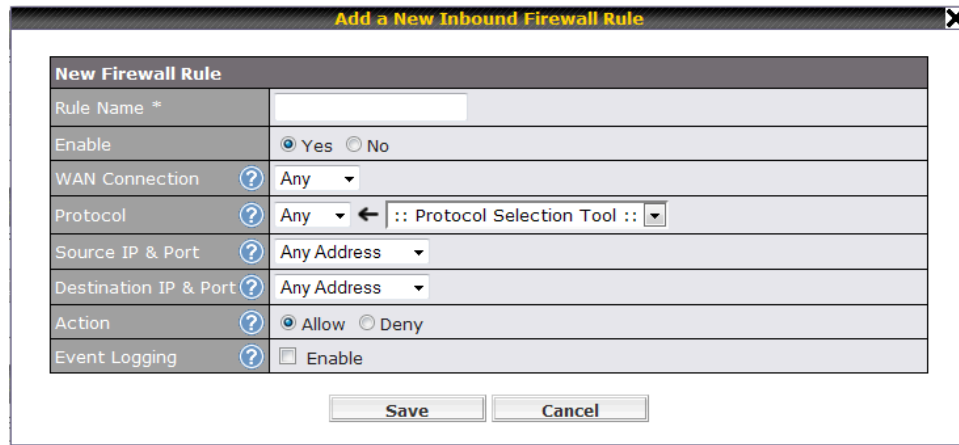

New Firewall Rule	
Rule Name *	<input type="text"/>
Enable	<input checked="" type="radio"/> Yes <input type="radio"/> No
WAN Connection	<input type="text" value="Any"/> ?
Protocol	<input type="text" value="Any"/> ? <input type="text" value=":: Protocol Selection Tool ::"/>
Source IP & Port	<input type="text" value="Any Address"/> ?
Destination IP & Port	<input type="text" value="Any Address"/> ?
Action	<input checked="" type="radio"/> Allow <input type="radio"/> Deny
Event Logging	<input type="checkbox"/> Enable ?

Rules are matched from top to the bottom. If a connection matches any one of the upper rules, the matching process will stop. If none of the rules is matching, the **Default** rule will be applied.

By default, the **Default** rule is set as **Allow** for both outbound and inbound accesses.

Inbound / Outbound Firewall Settings	
Rule Name	This setting specifies a name for the firewall rule.
Enable	<p>This setting specifies whether the firewall rule should take effect.</p> <p>When Yes is selected, the firewall rule takes effect. If the traffic matches the specified Protocol/IP/Port, actions will be taken by Pepwave MAX based on the other parameters of the rule.</p> <p>When No is selected, the firewall rule does not take effect. Pepwave MAX will disregard the other parameters of the rule.</p>
WAN Connection	<p>This setting is applicable to Inbound Firewall Rules only.</p> <p>This setting specifies which WAN connection(s) the rule applies to:</p> <ul style="list-style-type: none"> • WAN 1 • WAN 2 • Wi-Fi WAN • Cellular 1 • Cellular 2 • USB <p>A value of WAN 1, WAN 2, Wi-Fi WAN, Cellular 1, Cellular 2, ... and USB specifies that the rule applies to all WAN connections, Ethernet WAN, PC Card, ... and Wi-Fi WAN, respectively.</p>
Protocol	<p>This setting specifies the protocol to be matched by the rule.</p> <p>Via a drop-down menu, the following protocols can be specified:</p> <ul style="list-style-type: none"> • TCP • UDP • ICMP • IP

User Manual

PEPWAVE *MAX* mobile router

Alternatively, the **Protocol Selection Tool** drop-down menu can be used to automatically fill in the Protocol and Port number of common Internet services (e.g. HTTP, HTTPS, etc.) After selecting an item from the Protocol Selection Tool drop-down menu, the Protocol and Port number remains manually modifiable.

Source IP & Port

This specifies the source IP address(es) and port number(s) to be matched for a firewall rule.

A single address, or a network, can be specified as the Source IP & Port setting, as indicated with the following screenshots:

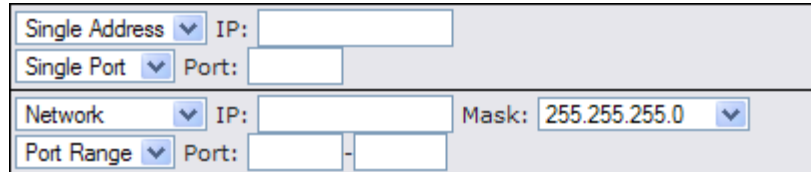

In addition, a single port, or a range of ports, can be specified for the Source IP & Port setting.

Destination IP & Port

This specifies the destination IP address(es) and port number(s) to be matched for a firewall rule.

A single address, or a network, can be specified as the Source IP & Port setting, as indicated with the following screenshots:

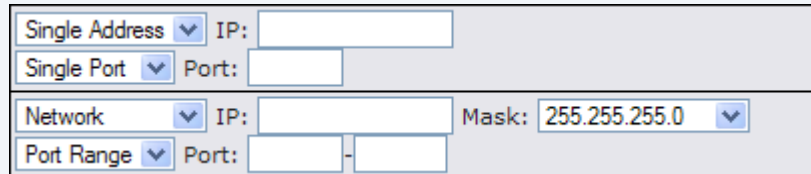

In addition, a single port, or a range of ports, can be specified for the Source IP & Port setting.

Action

This setting specifies the action to be taken by Pepwave MAX upon encountering traffic that matches the both of the following:

- Source IP & Port
- Destination IP & Port
- With the value of **Allow** for the Action setting, the matching traffic passes through Pepwave MAX (to be routed to the destination).
- If the value of the Action setting is set to **Deny**, the matching traffic does not pass through Pepwave MAX (and is discarded).

This setting specifies whether or not to log matched firewall events.

The logged messages are shown on the page **Status >Event Log**.

A sample message is as follows:

```
Aug 13 23:47:44 Denied CONN=Ethernet WAN SRC=20.3.2.1
DST=192.168.1.20 LEN=48 PROTO=TCP SPT=2260 DPT=80
```

Event Logging

- **CONN**: The connection where the log entry refers to
- **SRC**: Source IP address
- **DST**: Destination IP address
- **LEN**: Packet length
- **PROTO**: Protocol
- **SPT**: Source port
- **DPT**: Destination port

User Manual

PEPWAVE *MAX* mobile router

Tip

If the default inbound rule is set as **Allow** for NAT enabled WANs, no inbound Allow firewall rules will be required for inbound Port Forwarding and inbound NAT Mapping rules. However, if the default inbound rule is set as **Deny**, a corresponding Allow firewall rules will be required.

User Manual

PEPWAVE *MAX* mobile router

16.2 Intrusion Detection and DoS Prevention

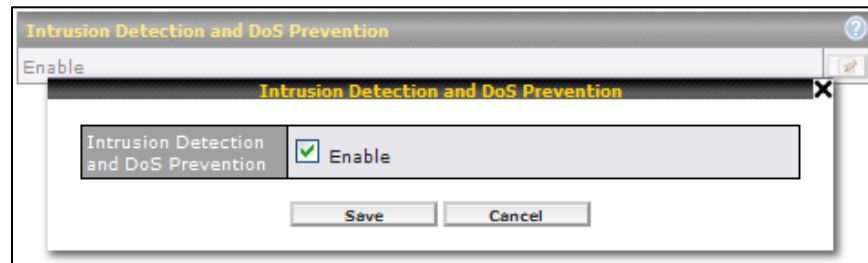

The Pepwave MAX supports detecting and preventing intrusions and Denial-of-Service (DoS) attacks from the Internet. To turn on this feature, click , check the box **Enable** for the **Intrusion Detection and DoS Prevention** and press the **Save** button.

When this feature is enabled, the Pepwave MAX will detect and protect the network from the following kinds of intrusions and denial-of-service attacks.

- Port Scan:
 - NMAP FIN/URG/PSH
 - Xmas Tree
 - Another Xmas Tree
 - Null Scan
 - SYN/RST
 - SYN/FIN
- SYN Flood Prevention
- Ping Flood Attack Prevention

17 Miscellaneous Settings

The miscellaneous settings include configuration for PPTP Server, Service Forwarding, and Service Passthrough.

17.1 PPTP Server

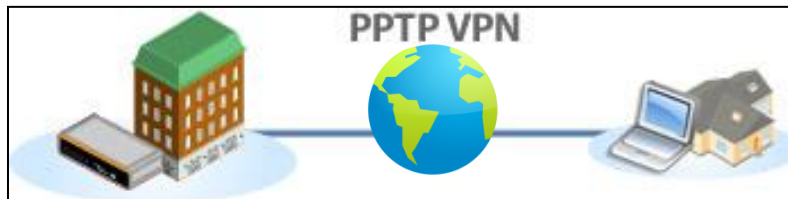

Pepwave MAX has a built-in PPTP Server, which enables remote computers to conveniently and securely access the local network.

PPTP server setting is located at **Advanced > Misc. Settings > PPTP Server**.

Simply check the box to enable the PPTP server function. All connected PPTP sessions are displayed on the Client List at **Status > Client List**. Please refer to section 19.3 for details.

PPTP Server															
Enable	<input checked="" type="checkbox"/>														
Listen On	<table border="1"> <thead> <tr> <th colspan="2">Connection / IP Address(es)</th> </tr> </thead> <tbody> <tr> <td><input checked="" type="checkbox"/> Ethernet WAN</td> <td><input checked="" type="checkbox"/> 123.123.123.1 (Interface IP)</td> </tr> <tr> <td><input type="checkbox"/> Express Card</td> <td></td> </tr> <tr> <td><input type="checkbox"/> PC Card</td> <td></td> </tr> <tr> <td><input type="checkbox"/> USB1</td> <td></td> </tr> <tr> <td><input type="checkbox"/> USB2</td> <td></td> </tr> <tr> <td><input type="checkbox"/> Wi-Fi Hotspot</td> <td></td> </tr> </tbody> </table>	Connection / IP Address(es)		<input checked="" type="checkbox"/> Ethernet WAN	<input checked="" type="checkbox"/> 123.123.123.1 (Interface IP)	<input type="checkbox"/> Express Card		<input type="checkbox"/> PC Card		<input type="checkbox"/> USB1		<input type="checkbox"/> USB2		<input type="checkbox"/> Wi-Fi Hotspot	
Connection / IP Address(es)															
<input checked="" type="checkbox"/> Ethernet WAN	<input checked="" type="checkbox"/> 123.123.123.1 (Interface IP)														
<input type="checkbox"/> Express Card															
<input type="checkbox"/> PC Card															
<input type="checkbox"/> USB1															
<input type="checkbox"/> USB2															
<input type="checkbox"/> Wi-Fi Hotspot															
User Accounts	<table border="1"> <thead> <tr> <th colspan="2">No User Account</th> </tr> </thead> <tbody> <tr> <td></td> <td><input type="button" value="Add"/></td> </tr> </tbody> </table>	No User Account			<input type="button" value="Add"/>										
No User Account															
	<input type="button" value="Add"/>														
<input type="button" value="Save"/>															

PPTP Server Setting

Listen On

This setting is for specifying the WAN connection(s) and IP address(es) where the PPTP server should listen on.

User Accounts

This setting allows you to define the PPTP User Accounts. Click **Add** to input username and password to create an account. After adding the user accounts, you can click on a username to edit the account password. Click the button  to delete the account in its corresponding row.

17.2 Service Forwarding

Service Forwarding settings are located at **Advanced > Misc. Settings > Service Forwarding**:

Service Forwarding	
SMTP Forwarding	When this option is enabled, all outgoing SMTP connections destined for any host at TCP port 25 will be intercepted. These connections will be redirected to a specified SMTP server and port number. SMTP server settings for each WAN can be specified after selecting Enable .
Web Proxy Forwarding	When this option is enabled, all outgoing connections destined for the proxy server specified in Web Proxy Interception Settings will be intercepted. These connections will be redirected to a specified web proxy server and port number. Web Proxy Interception Settings and proxy server settings for each WAN can be specified after selecting Enable .
DNS Forwarding	When this option is enabled, all outgoing DNS lookups will be intercepted and redirected to the built-in DNS name server. If any LAN device is using DNS name servers of a WAN connection, you may want to enable this option to enhance the DNS availability without modifying the DNS server setting of the clients. The built-in DNS name server will distribute DNS lookups to corresponding DNS servers of all available WAN connections. In this case, DNS service will not be interrupted even if any WAN connection is down.

17.2.1 SMTP Forwarding

Some ISPs require their users to send e-mails via the ISP's SMTP server. All outgoing SMTP connections are blocked except those connecting to the ISP's. The Pepwave MAX supports intercepting and redirecting all outgoing SMTP connections (destined for TCP port 25) via a WAN connection to the WAN's corresponding SMTP server.

Connection	Enable Forwarding?	SMTP Server	SMTP Port
Ethernet WAN	<input checked="" type="checkbox"/>	10.10.1.1	25
Express Card	<input type="checkbox"/>		
PC Card	<input type="checkbox"/>		
USB1	<input checked="" type="checkbox"/>	10.10.2.1	25
USB2	<input type="checkbox"/>		
Wi-Fi WAN	<input type="checkbox"/>		

User Manual

PEPWAVE *MAX* mobile router

To enable the feature, select the **Enable** check box under **SMTP Forwarding Setup**. Check the box **Enable Forwarding?** For the WAN connection(s) that needs such forwarding. Enter the ISP's e-mail server address and TCP port number for each WAN.

The Pepwave MAX will intercept SMTP connections, choose a WAN with reference to the Outbound Policy, and then forward the connection to the forwarded SMTP server if the chosen WAN has enabled forwarding. If the forwarding is disabled for a WAN connection, SMTP connections for the WAN will be simply forwarded to the connection's original destination.

Note

If you want to route all SMTP connections only to particular WAN connection(s), you should create a rule in Outbound Policy (see section 12.2).

17.2.2 Web Proxy Forwarding

Connection	Enable Forwarding?	Proxy Server IP Address : Port
Ethernet WAN	<input checked="" type="checkbox"/>	10.10.1.1 : 8123
Express Card	<input type="checkbox"/>	:
PC Card	<input type="checkbox"/>	:
USB1	<input checked="" type="checkbox"/>	10.10.2.1 : 8080
USB2	<input type="checkbox"/>	:
Wi-Fi WAN	<input checked="" type="checkbox"/>	10.10.3.1 : 8080

When this feature is enabled, the Pepwave MAX will intercept all outgoing connections destined for the proxy server specified in **Web Proxy Interception Settings**, choose a WAN connection with reference to the Outbound Policy, and then forward them to the specified web proxy server and port number. Redirected server settings for each WAN can be set here. If forwarding is disabled for a WAN, web proxy connections for the WAN will be simply forwarded to the connection's original destination.

17.2.3 DNS Forwarding

Forward Outgoing DNS Requests to Local DNS Proxy	<input checked="" type="checkbox"/> Enable
--	--

When DNS Forwarding is enabled, all clients' outgoing DNS requests will also be intercepted and forwarded to the built-in DNS proxy server.

User Manual

PEPWAVE *MAX* mobile router

17.3 Service Passthrough

Service Passthrough settings can be found in **Advanced > Misc. Settings > Service Passthrough**:

The screenshot shows the 'Service Passthrough Support' configuration page. It features a table with the following settings:

Service Passthrough Support	
SIP (Standard SIP, Vonage)	<input checked="" type="radio"/> Standard Mode <input type="radio"/> Compatibility Mode <input checked="" type="checkbox"/> Define custom signal ports 1. <input type="text"/> 2. <input type="text"/> 3. <input type="text"/>
H.323	<input checked="" type="checkbox"/> Enable
FTP	<input checked="" type="checkbox"/> Enable <input type="checkbox"/> Define custom control ports
TFTP	<input type="checkbox"/> Enable
IPsec NAT-T	<input checked="" type="checkbox"/> Enable <input type="checkbox"/> Define custom ports <input checked="" type="checkbox"/> Route IPsec Site-to-Site VPN via <input type="text" value="Ethernet WAN"/>

(Registered trademarks are copyrighted by their respective owner)

Some Internet services required to be specially handled in a multi-WAN environment. The Pepwave MAX supports handling such services correctly such that Internet applications do not notice it is behind a multi-WAN router. Settings for Service Passthrough Support are available here.

Service Passthrough Support	
SIP	<p>Session Initiation Protocol, aka SIP, is a voice-over-IP protocol. Pepwave MAX can act as a SIP Application Layer Gateway (ALG) which binds connections for the same SIP session to the same WAN connection and translate IP address in the SIP packets correctly in NAT mode. Such passthrough support is always enabled and there are two modes for selection: Standard Mode and Compatibility Mode.</p> <p>If your SIP server's signal port number is non-standard, you can check the box Define custom signal ports and input the port numbers to the text boxes.</p>
H.323	<p>With this option enabled, protocols that provide audio-visual communication sessions will be defined on any packet network and passthrough the device.</p>
FTP	<p>FTP sessions consist of two TCP connections; one for control and one for data. In multi-WAN situation, they have to be binded to the same WAN connection. Otherwise, problems will arise in transferring files. By default, the Pepwave MAX monitors TCP control connections on port 21 for any FTP connections and binds TCP connections of the same FTP session to the same WAN.</p> <p>If you have an FTP server listening on a port number other than 21, you can check the box Define custom control ports and enter the port numbers to the text boxes.</p>
TFTP	<p>The Pepwave MAX monitors outgoing TFTP connections and routes any incoming TFTP data packets back to the client. Select Enable if you want to enable the TFTP Passthrough support.</p>
IPsec NAT-T	<p>This field is for enabling the support of IPsec NAT-T Passthrough. UDP ports 500, 4500 and 10000 are monitored by default.</p> <p>You may add more custom data ports that your IPsec system uses by checking the box Define custom ports. If the VPN contains IPsec Site-to-Site VPN traffic, you have to check the box Route IPsec Site-to-Site VPN and choose the WAN connection to route the traffic to.</p> <p>If you have IPsec SpeedFusion™ traffic routed, check the Route IPsec SpeedFusion™ option and select a WAN to force routing such traffic to the specified WAN.</p>

User Manual

PEPWAVE *MAX* mobile router

18 System Settings

18.1 Admin Security

There are two user accounts available for accessing the Web Admin. Usernames are **admin** and **user**. They represent two user levels - **admin** has full administration access, while **user** is a read-only account. The read-only account can only access the device's status information and cannot make any change on the device.

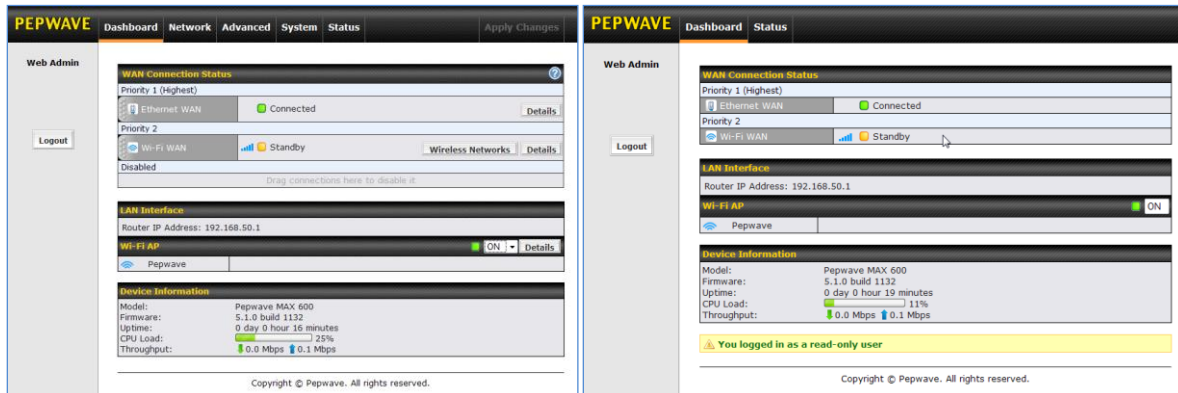

Admin Account UI

User Account UI

A web login session will be logged out automatically when it has been idle longer than the **Web Session Timeout**. Before the session expires, you may click the Logout button in the Web Admin to exit the session

0 hours 0 minutes signifies an unlimited session time. This setting should be used only in special situations, as it will lower the system security level if users do not logout before closing the browser.

Default: 4 hours 0 minutes.

For security reason, after logging in to the Web Admin Interface for the first time, it is recommended to change the administrator password.

Configuring the administration interface to be accessible only from the LAN can further improve system security.

Administrative Settings configuration is located at **System > Admin Security**.

User Manual

PEPWAVE *MAX* mobile router

Admin Settings ?	
Router Name	MAX_HD2_DE1F
Admin User Name	admin
Admin Password *
Confirm Admin Password *
Read-only User Name	user
User Password	
Confirm User Password	
Web Session Timeout ?	4 Hours 0 Minutes
Authentication by RADIUS ?	<input type="checkbox"/> Enable
CLI SSH & Console ?	<input type="checkbox"/> Enable
Security	HTTP
Web Admin Port	80 Default
Web Admin Access	LAN/WAN

WAN Connection Access Settings															
Allowed Source IP Subnets ?	<input checked="" type="radio"/> Any <input type="radio"/> Allow access from the following IP subnets only														
Allowed WAN IP Address(es)	<table border="1"> <thead> <tr> <th colspan="2">Connection / IP Address(es) All Clear</th> </tr> </thead> <tbody> <tr> <td><input checked="" type="checkbox"/> WAN 1</td> <td><input checked="" type="checkbox"/> 172.11.22.10 (Interface IP)</td> </tr> <tr> <td><input checked="" type="checkbox"/> WAN 2</td> <td><input checked="" type="checkbox"/> 10.80.11.2 (Interface IP)</td> </tr> <tr> <td><input checked="" type="checkbox"/> Wi-Fi WAN</td> <td><input checked="" type="checkbox"/> Interface IP</td> </tr> <tr> <td><input checked="" type="checkbox"/> Cellular 1</td> <td><input checked="" type="checkbox"/> 10.35.215.243 (Interface IP)</td> </tr> <tr> <td><input checked="" type="checkbox"/> Cellular 2</td> <td><input checked="" type="checkbox"/> Interface IP</td> </tr> <tr> <td><input checked="" type="checkbox"/> USB</td> <td><input checked="" type="checkbox"/> Interface IP</td> </tr> </tbody> </table>	Connection / IP Address(es) All Clear		<input checked="" type="checkbox"/> WAN 1	<input checked="" type="checkbox"/> 172.11.22.10 (Interface IP)	<input checked="" type="checkbox"/> WAN 2	<input checked="" type="checkbox"/> 10.80.11.2 (Interface IP)	<input checked="" type="checkbox"/> Wi-Fi WAN	<input checked="" type="checkbox"/> Interface IP	<input checked="" type="checkbox"/> Cellular 1	<input checked="" type="checkbox"/> 10.35.215.243 (Interface IP)	<input checked="" type="checkbox"/> Cellular 2	<input checked="" type="checkbox"/> Interface IP	<input checked="" type="checkbox"/> USB	<input checked="" type="checkbox"/> Interface IP
	Connection / IP Address(es) All Clear														
	<input checked="" type="checkbox"/> WAN 1	<input checked="" type="checkbox"/> 172.11.22.10 (Interface IP)													
	<input checked="" type="checkbox"/> WAN 2	<input checked="" type="checkbox"/> 10.80.11.2 (Interface IP)													
	<input checked="" type="checkbox"/> Wi-Fi WAN	<input checked="" type="checkbox"/> Interface IP													
	<input checked="" type="checkbox"/> Cellular 1	<input checked="" type="checkbox"/> 10.35.215.243 (Interface IP)													
	<input checked="" type="checkbox"/> Cellular 2	<input checked="" type="checkbox"/> Interface IP													
<input checked="" type="checkbox"/> USB	<input checked="" type="checkbox"/> Interface IP														
* Required															
Save															

User Manual

PEPWAVE *MAX* mobile router

Admin Settings	
Router Name	This field allows you to define a name for this Pepwave MAX unit. By default, Router Name is set as MAX_XXXX , where XXXX refers to the last 4 digits of the serial number of the device.
Admin User Name	It is set as admin by default and is not customizable.
Admin Password	This field allows you to specify a new administrator password.
Confirm Admin Password	This field allows you to verify and confirm the new administrator password.
Read-only User Name	It is set as user by default and is not customizable.
User Password	This field allows you to specify a new user password. Once the user password is set, the feature of read-only user will be enabled.
Confirm User Password	This field allows you to verify and confirm the new user password.
Web Session Timeout	This field specifies the number of hours and minutes that a web session can remain idle before the device terminates its access to Web Admin Interface. By default, it is set as 4 hours .
Authentication by RADIUS	With this box is checked, Web Admin will authenticate using an external RADIUS server. Authenticated users are treated as "admin" users with full read-write permission. Local "admin" and "user" accounts will be disabled. When the device is not able to communicate with the external RADIUS server, local accounts will be enabled again for emergency access. Authentication options will be available once this box is checked.
Auth Protocol	This specifies the authentication protocol used. Available options are MS-CHAP v2 and PAP .
Auth Server	This specifies the access address of the external RADIUS server.
Auth Server Secret	This is the secret for accessing the RADIUS server.
Auth Timeout	This option specifies the time value for authentication timeout.
Accounting Server	This specifies the access address of the external Accounting server.
Accounting Server Secret	This is the secret for accessing the Accounting server.
Network Connection	This option is for specifying the network connection which will be used for authentication connection. Users can choose from LAN, WAN and VPN connections.
Security	This option is for specifying the protocol(s) through which the Web Admin Interface can be accessible: <ul style="list-style-type: none"> • HTTP • HTTPS • HTTP/HTTPS
Web Admin Port	These fields are for specifying the port number at which the Web Admin Interface can be accessible.
Web Admin Access	This option is for specifying the network interfaces through which the Web Admin

User Manual

PEPWAVE *MAX* mobile router

Interface can be accessible:

- LAN only
- LAN/WAN
- If LAN/WAN is chosen, a WAN Connection Access Settings form will be displayed.

WAN Connection Access Settings

This field allows you to restrict web admin access only from defined IP subnets.

- **Any** - Allow web admin accesses to be from anywhere, without IP address restriction.
- **Allow access from the following IP subnets only** - Restrict web admin access only from the defined IP subnets. When this is chosen, a text input area will be displayed beneath:

Allowed Source IP Subnets

The screenshot shows a form titled "Allowed Source IP Subnets" with a help icon. It contains two radio buttons: "Any" (unselected) and "Allow access from the following IP subnets only" (selected). Below the radio buttons is a large empty text input area for entering IP subnets.

The allowed IP subnet addresses should be entered into this text area. Each IP subnet must be in form of w.x.y.z/m

Where w.x.y.z is an IP address (e.g. 192.168.0.0), and m is the subnet mask in CIDR format, which is between 0 and 32 inclusively. For example: 192.168.0.0/24

To define multiple subnets, separate each IP subnet one in a line. For example:

- 192.168.0.0/24
- 10.8.0.0/16

This is to choose which WAN IP address(es) the web server should listen on.

Allowed WAN IP Address(es)

The screenshot shows the "WAN Connection Access Settings" form. The "Allowed Source IP Subnets" section is at the top. Below it is the "Allowed WAN IP Address(es)" section, which is a table with columns for "Connection" and "IP Address(es)". The table has six rows, each with a checked checkbox in the "Connection" column and a checked checkbox in the "IP Address(es)" column. The "IP Address(es)" column contains the following values: "172.11.22.10 (Interface IP)", "10.80.11.2 (Interface IP)", "Interface IP", "10.35.215.243 (Interface IP)", "Interface IP", and "Interface IP". At the bottom of the form, there is a "Save" button and a note "* Required".

Connection	IP Address(es)
<input checked="" type="checkbox"/> WAN 1	<input checked="" type="checkbox"/> 172.11.22.10 (Interface IP)
<input checked="" type="checkbox"/> WAN 2	<input checked="" type="checkbox"/> 10.80.11.2 (Interface IP)
<input checked="" type="checkbox"/> Wi-Fi WAN	<input checked="" type="checkbox"/> Interface IP
<input checked="" type="checkbox"/> Cellular 1	<input checked="" type="checkbox"/> 10.35.215.243 (Interface IP)
<input checked="" type="checkbox"/> Cellular 2	<input checked="" type="checkbox"/> Interface IP
<input checked="" type="checkbox"/> USB	<input checked="" type="checkbox"/> Interface IP

User Manual

PEPWAVE *MAX* mobile router

18.2 Firmware Upgrade

The firmware of Pepwave MAX is upgradeable through Web Admin Interface. Firmware upgrade functionality is located at **System > Firmware**:

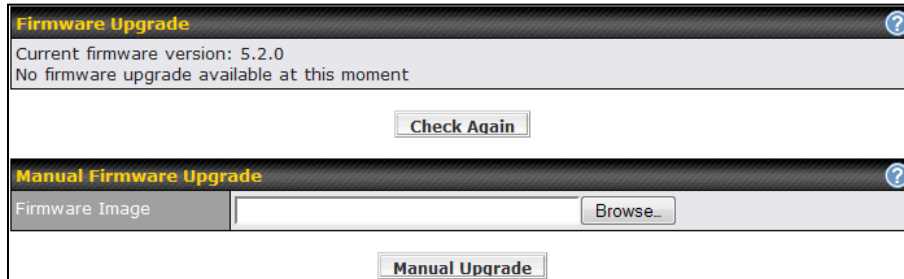

The screenshot shows two panels. The top panel, titled 'Firmware Upgrade', shows 'Current firmware version: 5.2.0' and 'No firmware upgrade available at this moment'. Below this is a 'Check Again' button. The bottom panel, titled 'Manual Firmware Upgrade', has a 'Firmware Image' label, an empty text input field, and a 'Browse...' button. At the bottom of this panel is a 'Manual Upgrade' button.

There are two ways to upgrade the unit. The first method is online firmware upgrade. The system can Check, Download and Upgrade over the Internet. The second method is to upload a firmware file manually.

Click on the **Check again** button to use online upgrade. With online upgrade, Pepwave MAX checks online for new firmware. If a new firmware is available, the Pepwave MAX will automatically download the firmware. The upgrade process will subsequently be automatically initiated.

You may also download a firmware image from the [Pepwave web site](#) and update the unit manually. Click **Browse** to select the firmware file from the local computer, and then click **Manual Upgrade** to send the firmware to Pepwave MAX. Pepwave MAX will then automatically initiate the firmware upgrade process.

Please note that all Pepwave devices are equipped to be able to store two different firmware versions in two different partitions. A firmware upgrade performed will always replace the inactive partition. If you want to keep the inactive firmware, you can simply reboot your device with the inactive firmware and then perform the firmware upgrade.

Important Note

The firmware upgrade process may not necessarily preserve the previous configuration, and the behavior varies on a case-by-case basis. Consult the Release Notes for the particular firmware version.

Do not disconnect the power during firmware upgrade process.

Do not attempt to upload a non-firmware file, or a firmware file that is not qualified, or not supported, by Pepwave. Upgrading a Pepwave MAX with an invalid firmware file will damage the unit, and may void the warranty.

Important Note

If the firmware is rolled back from 5.x to 4.x, the configurations will be lost.

18.3 Time

User Manual

PEPWAVE *MAX* mobile router

The Time Server functionality enables the system clock of Pepwave MAX to be synchronized with a specified Time Server.

The settings for Time Server configuration are located at **System > Time**:

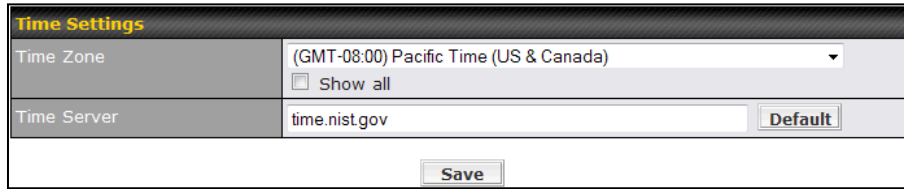

The screenshot shows the 'Time Settings' configuration page. It features a table with two rows: 'Time Zone' and 'Time Server'. The 'Time Zone' row has a dropdown menu set to '(GMT-08:00) Pacific Time (US & Canada)' and a checkbox labeled 'Show all' which is checked. The 'Time Server' row has a text input field containing 'time.nist.gov' and a 'Default' button. Below the table is a 'Save' button.

Time Server Settings	
Time Zone	This specifies the time zone (along with the corresponding Daylight Savings Time scheme) in which Pepwave MAX operates. The Time Zone value affects the time stamps in the Event Log of Pepwave MAX and E-mail notifications. Checked the box Show all to show all available time zone options.
Time Server	This setting specifies the NTP network time server to be utilized by Pepwave MAX.

18.4 Email Notification

The Email Notification functionality of Pepwave MAX provides a System Administrator with up-to-date information on network status.

The settings for configuring Email Notification are found at **System > Email Notification**:

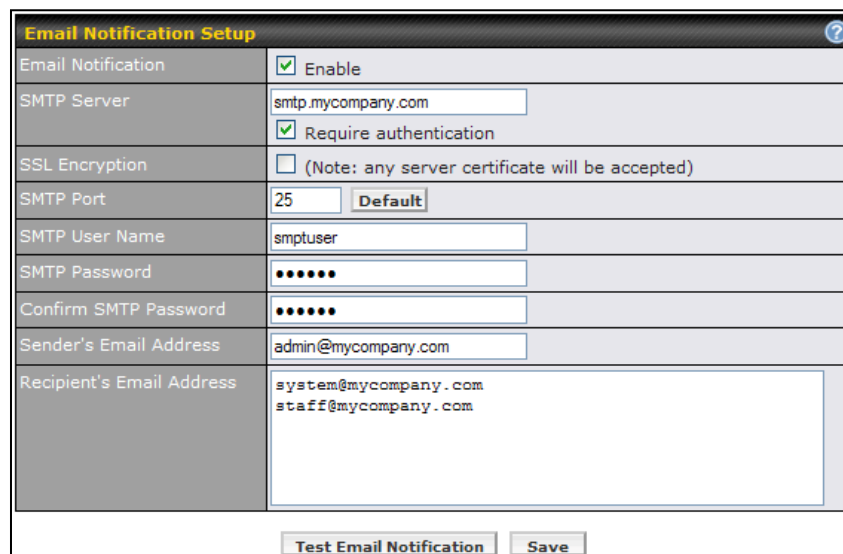

The screenshot shows the 'Email Notification Setup' configuration page. It features a table with the following rows: 'Email Notification' (checked 'Enable'), 'SMTP Server' (text input 'smtp.mycompany.com', checked 'Require authentication'), 'SSL Encryption' (unchecked, note: 'any server certificate will be accepted'), 'SMTP Port' (text input '25', 'Default' button), 'SMTP User Name' (text input 'smtuser'), 'SMTP Password' (password input field), 'Confirm SMTP Password' (password input field), 'Sender's Email Address' (text input 'admin@mycompany.com'), and 'Recipient's Email Address' (text area with 'system@mycompany.com' and 'staff@mycompany.com'). At the bottom are 'Test Email Notification' and 'Save' buttons.

User Manual

PEPWAVE *MAX* mobile router

Email Notification Settings

Email Notification	<p>This option is for enabling Email Notification.</p> <p>If the box Enable is checked, Pepwave MAX sends email messages to a System Administrator when the WAN status changes, or when new firmware is available.</p> <p>If the box Enable is not checked, Email Notification is disabled and Pepwave MAX will not send email messages.</p>
SMTP Server	<p>This field is for specifying the SMTP server to be used for sending email. If the server requires authentication, check the box Require authentication.</p>
SSL Encryption	<p>Check the box to enable SMTPS. When the box is checked, the next field SMTP Port will be changed to 465 automatically.</p>
SMTP Port	<p>This field is for specifying the SMTP Port number.</p> <p>By default, this is set to 25; when the SSL Encryption box is checked, the default port number will be set to 465.</p> <p>You may customize the port number by editing this field. Click the button Default to restore to default.</p>
SMTP User Name / Password	<p>This setting specifies the SMTP username and password while sending email. These options are shown only if Require authentication check box is checked in SMTP Server setting.</p>
Confirm SMTP Password	<p>This field allows you to verify and confirm the new administrator password.</p>
Sender's Email Address	<p>This setting specifies the sender email address reported by the email messages sent by Pepwave MAX.</p>
Recipient's Email Address	<p>This setting specifies the email addresses to which Pepwave MAX should send the email messages to. You may enter multiple recipients' email addresses in this field.</p>

After you have completed the settings, you can click the **Test Email Notification** button to test the settings before saving it. After it is clicked, you will see this screen to confirm the settings:

Test Email Notification	
SMTP Server	smtp.mycompany.com
SMTP Port	25
SMTP User Name	smtpuser
Sender's Email Address	admin@mycompany.com
Recipient's Email Address	system@mycompany.com staff@mycompany.com

Click **Yes** to confirm. Wait a few seconds, and you will see a return message and the detailed test result.

Test email sent. Email notification settings are not saved, it will be saved after clicked the 'Save' button.

User Manual

PEPWAVE *MAX* mobile router

Test Result

```
[INFO] Try email through connection #3
[<-] 220 ESMTP
[->] EHLO balance
[<-] 250-smtp Hello balance [210.210.210.210]
250-SIZE 100000000
250-8BITMIME
250-PIPELINING
250-AUTH PLAIN LOGIN
250-STARTTLS
250-PIPE
```

User Manual

PEPWAVE *MAX* mobile router

18.5 Remote Syslog

The Remote Syslog functionality of Pepwave MAX enables event logging at a specified remote Syslog server.

The settings for configuring Remote System Log are found at **System > Remote Syslog**:

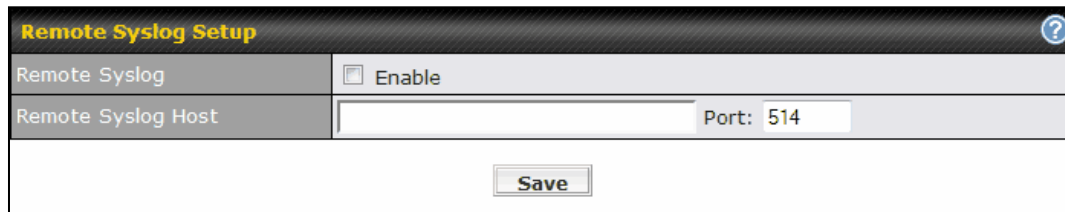

Remote Syslog Setup	
Remote Syslog	<input checked="" type="checkbox"/> Enable
Remote Syslog Host	<input type="text"/> Port: 514
<input type="button" value="Save"/>	

Remote Syslog Settings	
Remote Syslog	This setting specifies whether or not to log events at the specified remote Syslog server.
Remote Syslog Host	This setting specifies the IP address or host name of the remote Syslog server.
Port	This setting specifies the port number of the remote Syslog service. By default, the Port setting has value is 514 .

User Manual

PEPWAVE *MAX* mobile router

18.6 SNMP

SNMP or Simple Network Management Protocol is an open standard that can be used to collect information from the Pepwave MAX Mobile Router.

SNMP configuration is located at **System > SNMP**:

SNMP Settings			
SNMP Device Name	MAX		
SNMP Port	161	Default	
SNMPv1	<input checked="" type="checkbox"/> Enable		
SNMPv2c	<input checked="" type="checkbox"/> Enable		
SNMPv3	<input checked="" type="checkbox"/> Enable		
Save			
Community Name	Allowed Source Network	Access Mode	
kurt	192.168.50.1/24	Read Only	Delete
Add SNMP Community			
SNMPv3 User Name	Authentication / Privacy	Access Mode	
MyUser	MD5 / DES	Read Only	Delete
Add SNMP User			

SNMP Settings	
SNMP Device Name	This field shows the router name defined in System > Admin Security .
SNMP Port	This option specifies the port which SNMP used. The default port is set as 161 .
SNMPv1	This option allows you to enable SNMP version 1.
SNMPv2	This option allows you to enable SNMP version 2.
SNMPv3	This option allows you to enable SNMP version 3.

To add a community for either SNMPv1 or SNMPv2, click the **Add SNMP Community** button in the **Community Name** table, upon which the following screen will be displayed:

SNMP Community Setting	
Community Name	MyCompany
Allowed Source Subnet Address	192.168.1.20
Allowed Source Subnet Mask	255.255.255.0
Save	

User Manual

PEPWAVE *MAX* mobile router

SNMP Community Settings

Community Name	This setting specifies the SNMP Community Name.
Allowed Source Subnet Address	This setting specifies a subnet from which access to the SNMP server is allowed. Enter subnet address here (e.g. 192.168.1.0).
Allowed Source Subnet Mask	This setting specifies the subnet mask that corresponds to the subnet specified via Allowed Source Subnet Address (e.g. 255.255.255.0).

To define a user name for SNMPv3, click **Add SNMP User** in the **SNMPv3 User Name** table, upon which the following screen is displayed:

SNMPv3 User Setting	
User Name	snmpuser
Authentication Protocol	MD5 ▾
Authentication Password	mypassword
Privacy Protocol	DES ▾
Privacy Password	myprivpasswd
<input type="button" value="Save"/>	

SNMPv3 User Settings

User Name	This setting specifies a user name to be used in SNMPv3.
Authentication Protocol	<p>This setting specifies via a drop-down menu the one of the following valid authentication protocols:</p> <ul style="list-style-type: none"> • NONE • MD5 • SHA
Authentication Password	This setting specifies the authentication password, and is applicable only if the MD5 or SHA authentication protocol is selected.
Privacy Protocol	<p>This setting specifies via a drop-down menu the one of the following valid privacy protocols:</p> <ul style="list-style-type: none"> • NONE • DES
Privacy Password	This setting specifies the privacy password, and is applicable only if the DES privacy protocol is selected.

User Manual

PEPWAVE *MAX* mobile router

18.7 InControl

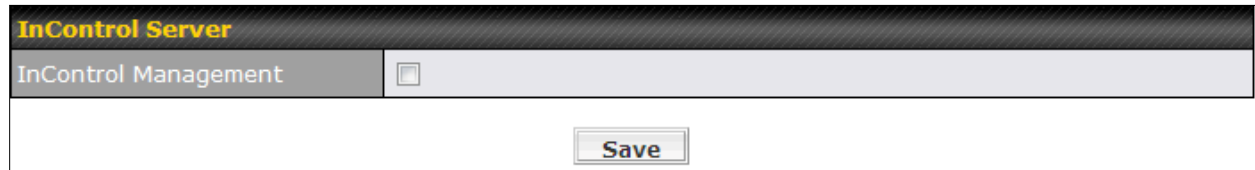

InControl Server	
InControl Management	<input type="checkbox"/>
<input type="button" value="Save"/>	

When this check box is checked, the device's status information, usage data, and configuration will be sent to Pepwave's InControl system. You can sign up for an InControl account at <https://incontrol.pepwave.com/>. You can register devices under the account, monitor device status and usage reports, and download backed up configuration files.

Default: Disabled

User Manual

PEPWAVE *MAX* mobile router

18.8 Configuration

Backing up the Pepwave MAX settings immediately after successful completion of the initial setup is strongly recommended.

The functionality to download and upload Pepwave MAX settings is found at **System > Configuration**

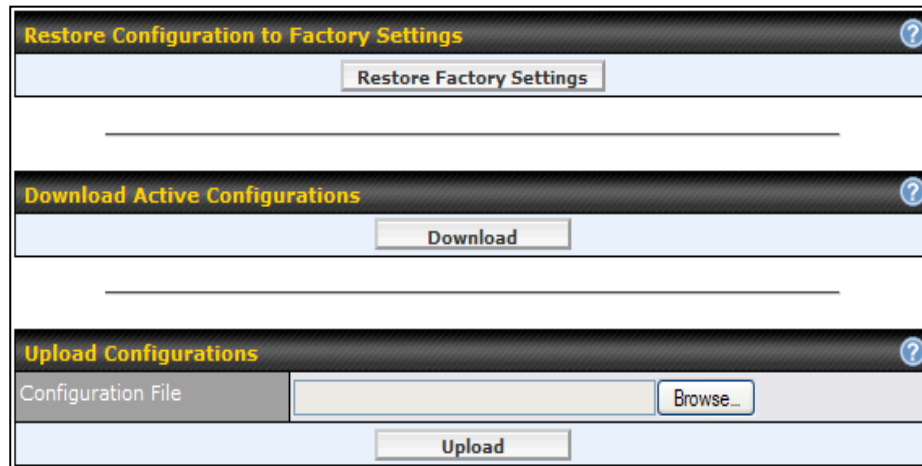

The screenshot displays a web interface with three distinct sections, each with a title bar containing a question mark icon:

- Restore Configuration to Factory Settings:** Contains a single button labeled "Restore Factory Settings".
- Download Active Configurations:** Contains a single button labeled "Download".
- Upload Configurations:** Features a "Configuration File" label, a text input field, a "Browse..." button, and an "Upload" button below.

18.8.1 Restore Configuration to Factory Settings

The **Restore Factory Settings** button is to reset the configuration to the factory default settings. You have to click the **Apply Changes** button to make the settings effective.

18.8.2 Downloading Active Configurations

The **Download** button is to backup the current active settings. Click **Download** and save the configuration file.

18.8.3 Uploading Configurations

To restore or change settings based on a configuration file, click **Browse...** to locate the configuration file on the local computer, and then click **Upload**.

The new settings can then be applied by clicking the **Apply Changes** button on the page header, or discard at the Main page of Web Administration Interface.

User Manual

PEPWAVE *MAX* mobile router

18.9 Reboot

This page provides a Reboot button for restarting the system.

For highest reliability, Pepwave MAX is equipped with two copies of firmware of different version. You can select the firmware version you would like the device to reboot with.

The firmware marked with **(Running)** is the current system boot up firmware.

Please note that a firmware upgrade will always replace the inactive firmware partition.

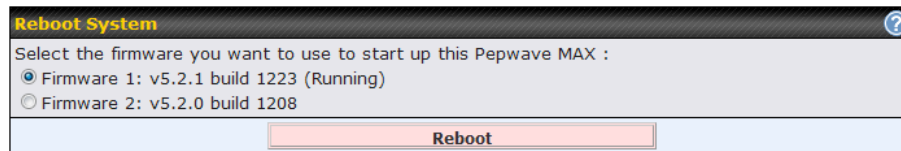

User Manual

PEPWAVE *MAX* mobile router

18.10 Ping Test

The Ping Test tool in Pepwave MAX performs Pings through a specified Ethernet interface or a SpeedFusion™ connection. You can specify the number of pings in the field **Number of times** to a maximum of 10 times, and Packet Size can be specified in the field **Packet Size** to a maximum of **1472** bytes.

The Ping utility is located at **System > Tools > Ping**, illustrated as follows:

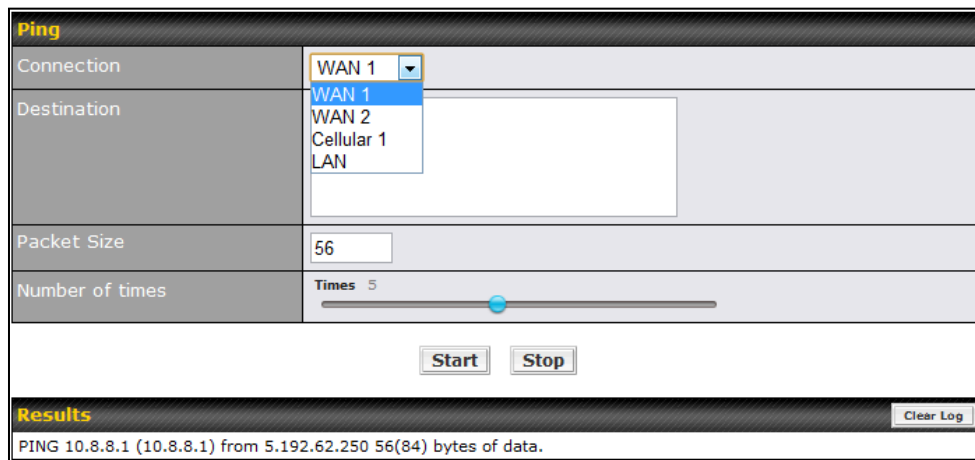

Ping	
Connection	WAN 1
Destination	WAN 1 WAN 2 Cellular 1 LAN
Packet Size	56
Number of times	Times 5
<input type="button" value="Start"/> <input type="button" value="Stop"/>	
Results	
<input type="button" value="Clear Log"/>	
PING 10.8.8.1 (10.8.8.1) from 5.192.62.250 56(84) bytes of data.	

Tip

A system administrator can use the Ping utility to manually check the connectivity of a particular LAN/WAN connection.

User Manual

PEPWAVE *MAX* mobile router

18.11 Traceroute Test

The Traceroute Test tool in Pepwave MAX traces the routing path to the destination through a particular Ethernet interface or SpeedFusion™ connection.

The Traceroute Test utility is located at **System > Tools > Traceroute**, illustrated as follows:

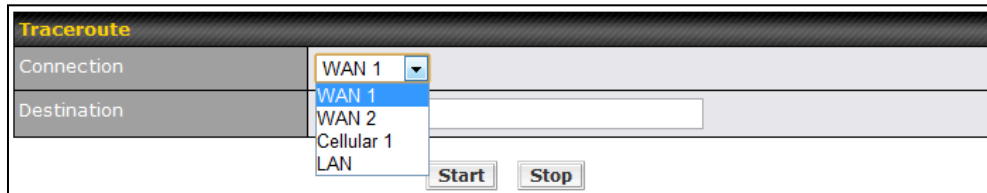

The screenshot shows the 'Traceroute' configuration window. It has a 'Connection' dropdown menu set to 'WAN 1'. Below it, a 'Destination' dropdown menu is open, showing options: 'WAN 1', 'WAN 2', 'Cellular 1', and 'LAN'. To the right of the destination dropdown is an empty text input field. At the bottom of the window are 'Start' and 'Stop' buttons.

Tip

A system administrator can use the Traceroute utility to analyze the connection path of a LAN/WAN connection.

18.12 SpeedFusion™ Test

The SpeedFusion™ tool can help to test the throughput between different VPN peers.

You can define the **Test Type**, **Direction**, and **Duration** of the test, and press **Go!** to perform the throughput test.

The VPN Test utility is located at **System > Tools > SpeedFusion™** illustrated as follows:

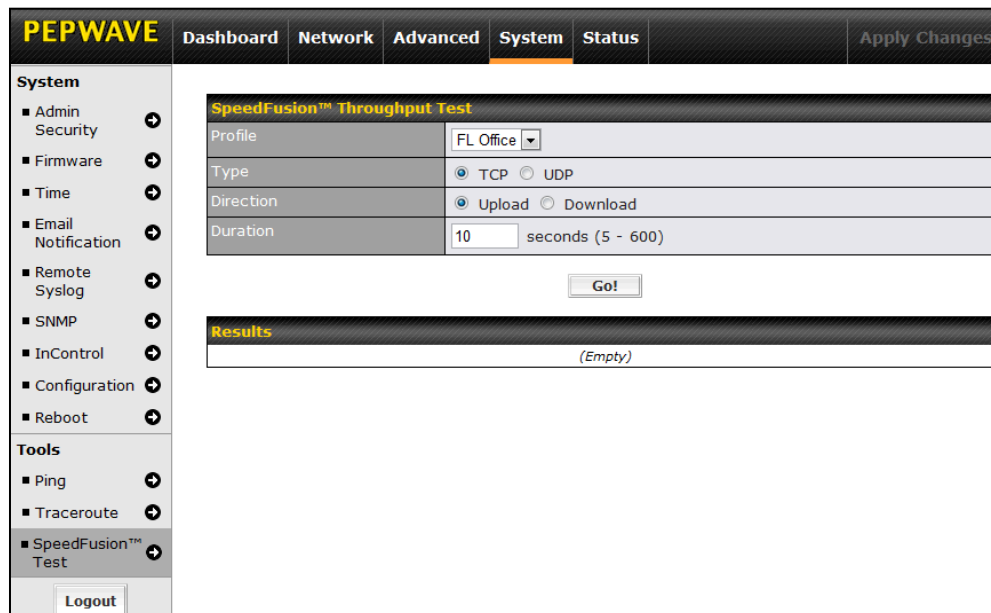

The screenshot shows the 'PEPWAVE' web interface with the 'System' tab selected. The left sidebar contains a tree view with 'System' and 'Tools' sections. Under 'Tools', 'SpeedFusion™ Test' is selected. The main content area is titled 'SpeedFusion™ Throughput Test'. It contains the following fields:

- Profile: 'FL Office' (dropdown)
- Type: Radio buttons for 'TCP' (selected) and 'UDP'
- Direction: Radio buttons for 'Upload' (selected) and 'Download'
- Duration: '10' (input) seconds (5 - 600)

A 'Go!' button is located below the duration field. Below the configuration fields is a 'Results' section with the text '(Empty)'. At the bottom left of the sidebar is a 'Logout' button.

User Manual

PEPWAVE *MAX* mobile router

18.13 CLI (Command Line Interface Support)

The CLI (Command Line Interface) can be accessed via SSH. This field enables CLI support.

The below settings specify which TCP port and which interface(s) should accept remote SSH CLI access. The user name and password used for remote SSH CLI access are the same as those used for web admin access.

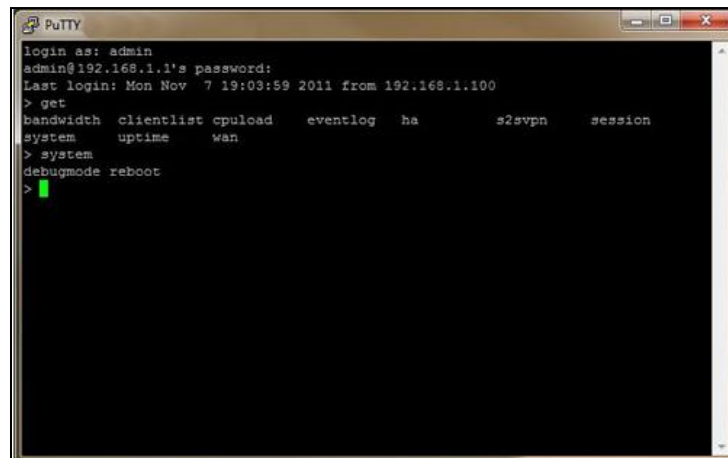

```
login as: admin
admin@192.168.1.1's password:
Last login: Mon Nov  7 19:03:59 2011 from 192.168.1.100
> get
bandwidth  clientlist  cpuload   eventlog  ha        s2svpn   session
system     uptime    wan
> system
debugmode  reboot
>
```

User Manual

PEPWAVE *MAX* mobile router

19 Status

This section displays the information of Pepwave MAX on the *Device*, *Active Sessions*, *Client List*, *WINS Client List*, *SpeedFusion™*, *UPnP / NAT-PMP*, *Event Log*, and *Bandwidth*.

19.1 Device

System information is located at *Status > Device*:

System Information	
Router Name	MAX_HD2_DE1F
Model	Pepwave MAX HD2
Hardware Revision	2
Serial Number	1824-5F7E-FF03
Firmware	5.4.0
Modem Support Version	1005 (Modem Support List)
Uptime	0 day 8 hours 40 minutes
System Time	Tue Mar 06 14:15:27 WET 2012
GPX File	 2012-02-17 <input type="button" value="Download"/>
Diagnostic Report	Download

Interface	MAC Address
LAN Port	10:56:CA:00:00:01
WAN 1	10:56:CA:00:00:02
WAN 2	10:56:CA:00:00:03
Wi-Fi WAN	10:56:CA:00:00:04

 [Legal](#)

System Information	
Router Name	This is the name specified in the field Router Name located in <i>System > Admin Security</i> .
Model	This shows the model name and number of this device.
Hardware Revision	This shows the hardware version of this device.
Serial Number	This shows the serial number of this device.
Firmware	This shows the firmware version that this device is currently running.
Modem Support Version	This shows the modem support version of this device. A Modem Support List link redirects users to a list of cellular modems supported by this device.
Uptime	This shows the length of time since the device is rebooted.
System Time	This shows the current system time.
GPX File (HD2 Only)	This contains the GPS data of the latest 7 days. A Download button is for exporting the data in GPX format of the selected date. For more information about how GPS works in

User Manual

PEPWAVE *MAX* mobile router

HD2, please refer to section 19.1.1.

Diagnostic Report

A **Download** button is for exporting a diagnostic report file required for system investigation.

The second table shows the MAC address of each LAN/WAN interface connected.

Important Note

If you encounter issues and would like to contact Pepwave Support Team (<http://www.pepwave.com/contact>), please download the diagnostic report file and attach it along with a description of your encountered issue.

In firmware 5.1 or before, Diagnostic Report file can be obtained at **System > Reboot**

19.1.1 GPS Data

The MAX HD2 automatically stores up to seven days of GPS location data in GPS eXchange format (GPX). To review this data using third-party applications, click **Status > Device** and then download your GPX file.

The Pepwave MAX HD2 exports real-time location data in NMEA format through its LAN IP address at TCP port 60660. It is accessible from LAN or over a SpeedFusion connection. To access the data via a virtual serial port, you have to install a virtual serial port driver. Visit <http://www.peplink.com/index.php?view=faq&id=294> to download the driver.

User Manual

PEPWAVE *MAX* mobile router

19.2 Active Sessions

Information on Active Sessions is at **Status > Active Sessions > Overview**

PEPWAVE Dashboard Network Advanced System **Status** Apply Changes

Status

- Device
- Active Sessions**
- Client List
- SpeedFusion™
- Event Log

Bandwidth

- Real-Time
- Hourly
- Daily
- Monthly

Logout

Overview Search

Session data captured within one minute. Refresh

Service	Inbound Sessions	Outbound Sessions
No known sessions		

Interface	Inbound Sessions	Outbound Sessions
WAN 1	0	0
WAN 2	0	0
Wi-Fi WAN	0	0
Cellular 1	0	0
Cellular 2	0	0
USB	0	0

PEPWAVE Dashboard Network Advanced System **Status** Apply Changes

Status

- Device
- Active Sessions**
- Client List
- SpeedFusion™
- Event Log

Bandwidth

- Real-Time
- Hourly
- Daily
- Monthly

Logout

Overview Search

Session data captured within one minute. Refresh

IP / Subnet Source or Destination / 255.255.255.255 (/32)

Port Source or Destination

Protocol / Service Any

Interface WAN 1 WAN 2 Wi-Fi WAN
 Cellular 1 Cellular 2 USB
 VPN

Search

Outbound						
Protocol	Source IP	Destination IP	Service	Interface	Life Time	
TCP	192.168.1.110:4147	123.123.123.1:443	HTTPS	WAN1	00:00:02	
ICMP	192.168.1.110	60.60.60.1		WAN1	00:00:02	
TCP	192.168.1.110:2423	123.123.123.1:443	HTTP	WAN1	00:00:13	
TCP	192.168.1.110:1144	123.123.123.123:5222	XMPP Client	WAN2	00:00:19	
TCP	192.168.1.110:1156	65.65.65.1:1963		WAN1	00:00:22	
UDP	192.168.1.110:62817	90.123.90.1:123	NTP	WAN2	00:00:26	

Inbound						
Protocol	Source IP	Destination IP	Service	Interface	Life Time	
UDP	10.10.10.112:1024	192.168.1.110:514	Syslog	WAN1	00:00:20	

This Active Sessions section displays the active inbound / outbound and UDP / TCP sessions of each WAN connection on Pepwave MAX.

A filter is available to help sort out the active session information. Enter a keyword in the field or check one of the WAN connection boxes for filtering.

User Manual



PEPWAVE *MAX* mobile router

19.3 Client List

The client list table is located at **Status > Client List**. It lists DHCP client IP addresses, their Names (retrieved from DHCP reservation table or defined by users), current **Download and Upload rate** and MAC addresses that the Pepwave MAX has offered IP addresses to since it is powered up. Network Name (SSID) and Signal refers to the information about Wi-Fi AP, which is the name of the Network and its signal strength. Clients can be imported into DHCP Reservation table by clicking the  button on the right-most column. Further update the record after the import by going to **Network > LAN**.

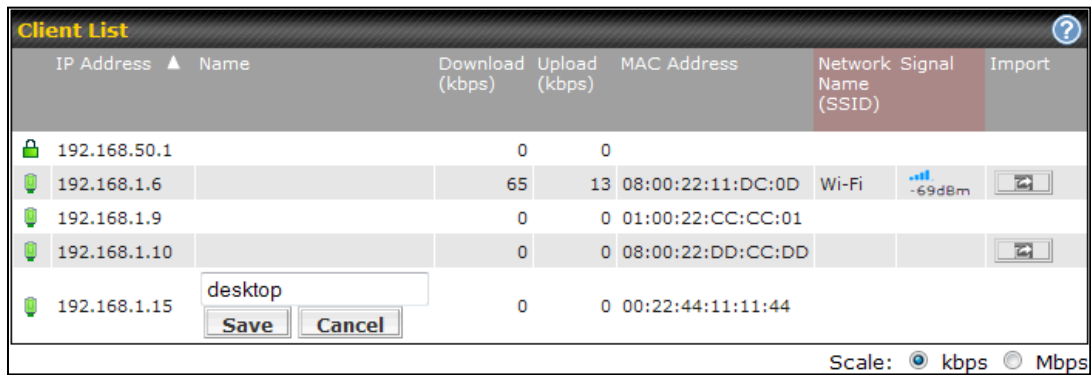
If PPTP Server in section 17.1 is enabled, you may see the corresponding connection name would be listed in the field of **Name**.



IP Address	Name	Download (kbps)	Upload (kbps)	MAC Address	Network Name (SSID)	Signal	Import
192.168.50.1		0	0				
192.168.1.6		65	13	08:00:22:11:DC:0D	Wi-Fi	-69dBm	
192.168.1.9		0	0	01:00:22:CC:CC:01			
192.168.1.10		0	0	08:00:22:DD:CC:DD			
192.168.1.15	desktop	0	0	00:22:44:11:11:44			

Scale: kbps Mbps

User Manual

PEPWAVE *MAX* mobile router

19.4 WINS Client

The WINS client list table is located at **Status > WINS Client**. It lists WINS client IP addresses and their Names. This option will only be available when you have enabled the WINS Server in section 7.1.

Name of clients retrieved will be automatically matched into Client List in the previous section.

Click the button **Flush All** to flush all WINS client records.

WINS Client List	
Name ▲	IP Address
UserA	10.9.2.1
UserB	10.9.30.1
UserC	10.9.2.4

19.5 SpeedFusion™

This is a page showing the current status of SpeedFusion™, located at: **Status > SpeedFusion™**

Details about peer's WAN connections are listed as below.

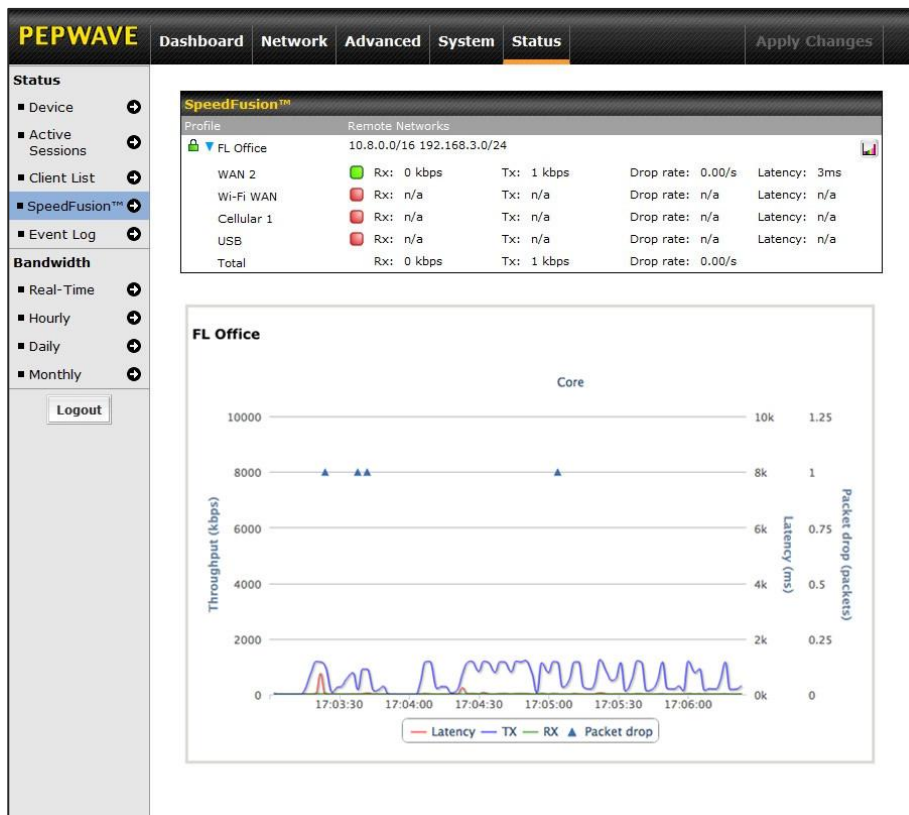







User Manual

PEPWAVE *MAX* mobile router

19.6 UPnP / NAT-PMP

The table that shows the forwarded ports under UPnP and NAT-PMP protocols is located at **Status > UPnP / NAT-PMP**:

This section appears only if you have enabled the function of UPnP / NAT-PMP as mentioned in Section 13.2.

Forwarded Ports						
External	Internal	Internal Address	Type	Protocol	Description	
47453	3392	192.168.1.100	UPnP	UDP	Application 031	
35892	11265	192.168.1.50	NAT-PMP	TCP	NAT-PMP 58	
4500	3560	192.168.1.20	UPnP	TCP	Application 013	
5921	236	192.168.1.30	UPnP	TCP	Application 047	
22409	8943	192.168.1.70	NAT-PMP	UDP	NAT-PMP 97	
2388	27549	192.168.1.40	UPnP	TCP	Application 004	
						<input type="button" value="Delete All"/>

Click the button  to delete the single UPnP / NAT-PMP record in its corresponding row. To delete all records, click **Delete All** on the right-hand side below the table.

Important Note

UPnP / NAT-PMP records would be deleted immediately after clicking the button  or **Delete All** without the need to click Save or Confirm.

User Manual

PEPWAVE *MAX* mobile router

19.7 Event Log

Event Log information is located at **Status > Event Log**:

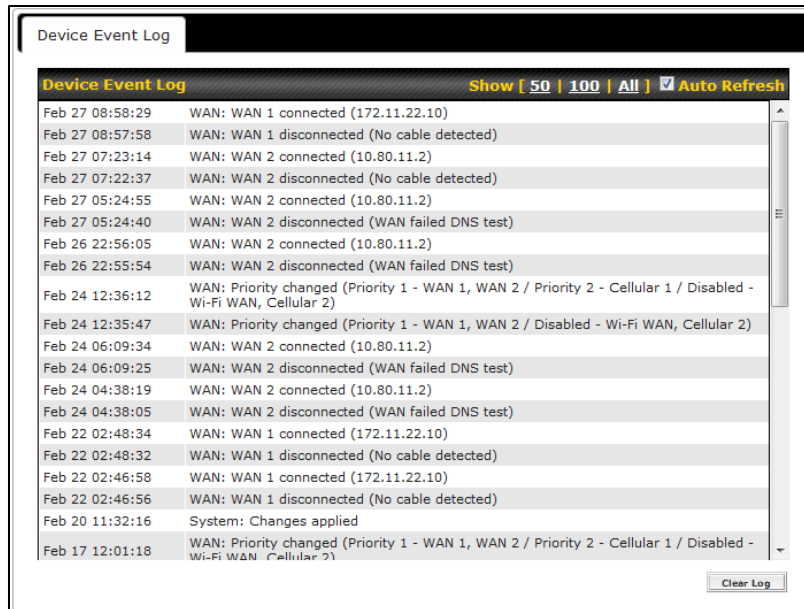

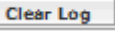
The log section displays a list of events that has taken place on the Pepwave MAX unit. Click the **Auto Refresh** to retrieve log entries again. Click the **Clear Log** button  to clear the log. Select **50**, **100**, or **all** to show the corresponding number of events in the log.

User Manual

PEPWAVE *MAX* mobile router

19.8 Bandwidth

This section shows the bandwidth usage statistics, located at: **Status > Bandwidth**

Bandwidth usage at the LAN and when the device is switched off, bandwidth usage is not recorded and not shown.

19.8.1 Real-Time

The **Data transferred since installation** shows you how many network traffic has been processed by your device since first boot.

Click **Show Details** in the top right hand corner of each table and the details of data transferred will be shown.

The check box **Stacked** below the data transferred graph can be checked to show the aggregated transferred rate of both traffic directions.

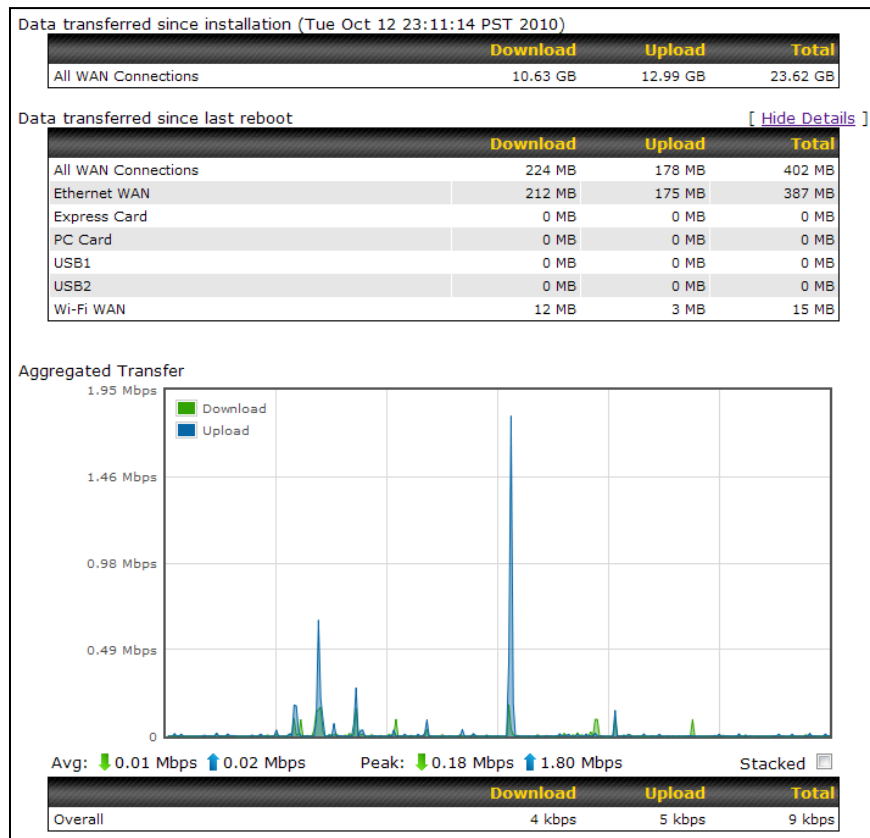

User Manual

PEPWAVE *MAX* mobile router

19.8.2 Hourly

This page shows the daily bandwidth usage for all and each WAN connection.

Select the connection in which you want to check its usage from the drop down menu

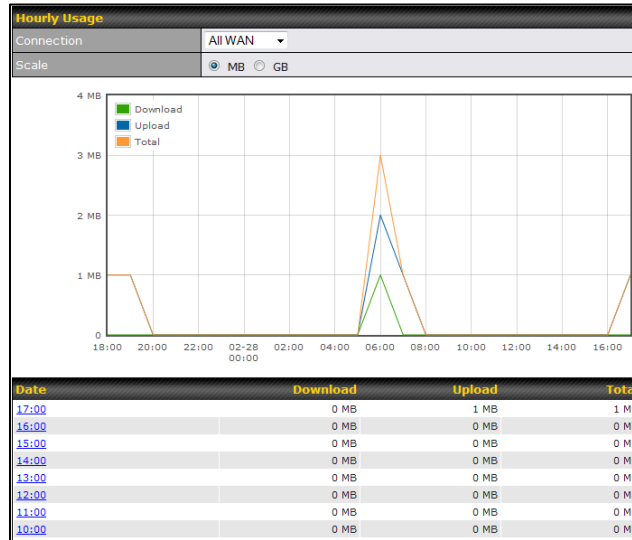

19.8.3 Daily

This page shows the daily bandwidth usage for all and each WAN connection.

Select the connection in which you want to check its usage from the drop down menu. If you have enabled **Bandwidth Monitoring** feature as shown in section 8.5, the **Current Billing Cycle** table for that WAN connection will be displayed.

Click on a date to view the client bandwidth usage of that specific date. This feature is not available if you have selected to view the bandwidth usage of only a particular WAN connection.

The Scale of the graph can be set to show in **Megabyte (MB)** or **Gigabyte (GB)**.

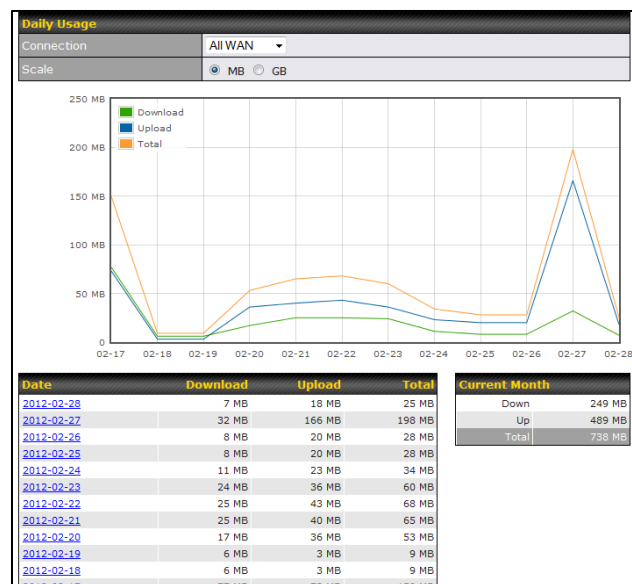

All WAN Daily Bandwidth Usage

User Manual

PEPWAVE *MAX* mobile router

19.8.4 Monthly

This page shows the monthly bandwidth usage for each WAN connection.

If you have enabled **Bandwidth Monitoring** feature as shown in section 8.5, you can choose a particular connection to check its usage and select to show the monthly usage period in **Billing Cycle** or **Calendar Month**.

Click the first or second row to view the client bandwidth usage of the current month. This feature is not available if you have chosen to view the bandwidth usage of only a particular WAN connection.

The Scale of the graph can be set to show in **Megabyte (MB)** or **Gigabyte (GB)**.

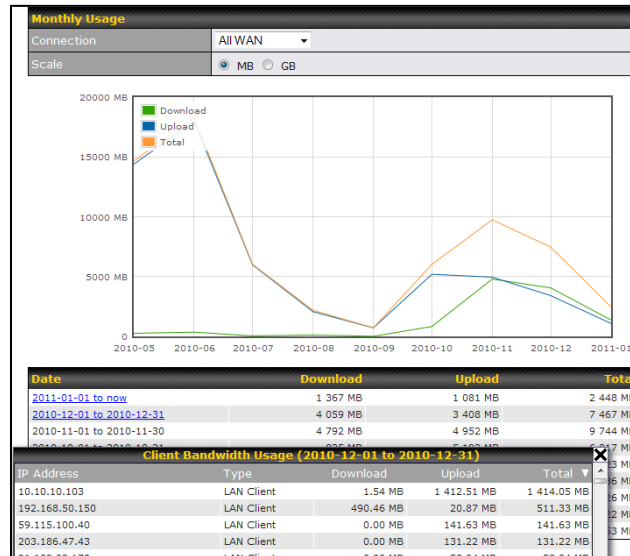

All WAN Monthly Bandwidth Usage

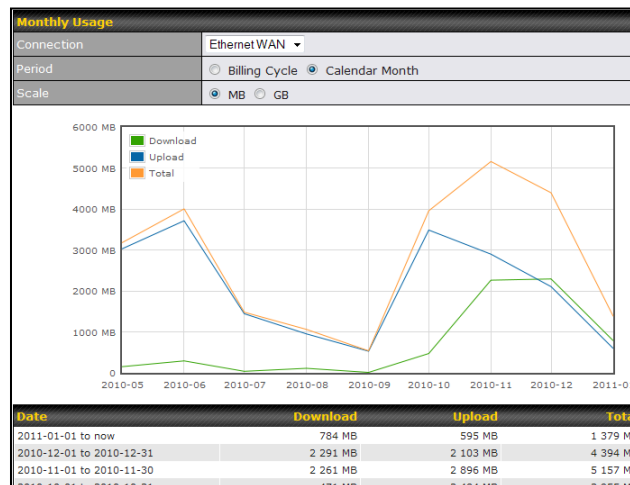

Ethernet WAN Monthly Bandwidth Usage

Tip

By default, the scale of data size is in **MB**. 1GB equals to 1024MB.

Appendix A. Restoration of Factory Defaults

To restore the factory default settings on a Pepwave MAX unit, follow the steps below:

1. Locate the reset button on the front panel of Pepwave MAX unit.
2. With a paper clip, press the reset button and hold it for at least 10 seconds until the unit reboots itself.

After Pepwave MAX finishes rebooting, the factory default settings will be restored.

Important Note

All previous configurations and bandwidth usage data will be lost after restoring the factory default settings. Regular backup of configuration settings is strongly recommended.

Appendix B. Declaration

1. **The device supports time division technology**
2. **Federal Communication Commission Interference Statement**

This equipment has been tested and found to comply with the limits for a Class B digital device, pursuant to Part 15 of the FCC Rules. These limits are designed to provide reasonable protection against harmful interference in a residential installation. This equipment generates uses and can radiate radio frequency energy and, if not installed and used in accordance with the instructions, may cause harmful interference to radio communications. However, there is no guarantee that interference will not occur in a particular installation. If this equipment does cause harmful interference to radio or television reception, which can be determined by turning the equipment off and on, the user is encouraged to try to correct the interference by one of the following measures:

- 1) Reorient or relocate the receiving antenna.
- 2) Increase the separation between the equipment and receiver.
- 3) Connect the equipment into an outlet on a circuit different from that to which the receiver is connected.
- 4) Consult the dealer or an experienced radio/TV technician for help.

This device complies with Part 15 of the FCC Rules. Operation is subject to the following two conditions: (1) This device may not cause harmful interference, and (2) this device must accept any interference received, including interference that may cause undesired operation.

FCC Caution: Any changes or modifications not expressly approved by the party responsible for compliance could void the user's authority to operate this equipment.

IEEE 802.11b or 802.11g operation of this product in the U.S.A. is firmware-limited to channels 1 through 11.

IMPORTANT NOTE

FCC Radiation Exposure Statement

This equipment complies with FCC radiation exposure limits set forth for an uncontrolled environment.

This equipment should be installed and operated with minimum distance 20cm between the radiator & your body.

This transmitter must not be co-located or operating in conjunction with any other antenna or transmitter.

The availability of some specific channels and/or operational frequency bands are country dependent and are firmware programmed at the factory to match the intended destination.

PEP WAVE

Broadband Possibilities

www.pepwave.com



What are we doing at the moment?
Follow us on [Twitter!](#)
<http://twitter.com/Peplink>



Want to know more about us?
Add us on [Facebook!](#)
<http://www.facebook.com/peplink>



Difficulties when configuring the device?
Visit Our [YouTube Channel!](#)
<http://www.youtube.com/PeplinkChannel>

Contact Us:

Sales

<http://www.pepwave.com/contact/sales/>

Support

<http://www.pepwave.com/contact/>

Business Development and Partnerships

<http://www.pepwave.com/partners/channel-partner-program/>