



Balance and MediaFast

User Manual

Peplink Products:

One / One Core / Two / 20 / 20X / 30 LTE / 30 Pro / 210 / 310 / 310X / 310 5G / 310 Fiber 5G / 305 / 380 / 380X / 580 / 580X / 710 / 1350 / 2500 / EPX / SDX / SDX Pro / MediaFast 200 / 500 / 750

Peplink Balance Firmware 8.2.0
March 2022

COPYRIGHT & TRADEMARKS

Specifications are subject to change without notice.

Copyright © 2021 Peplink Pepwave Ltd. All Rights Reserved. Pepwave and the Pepwave logo are trademarks of Peplink International Ltd. Other brands or products mentioned may be trademarks or registered trademarks of their respective owners.

Table of Contents

Introduction and Scope	10
Glossary	11
Product Comparison Charts	12
Balance Routers (for Small Office / Branch)	12
Balance Routers (for for Enterprise / Headquarters)	13
MediaFast Routers	14
Product Features	15
WAN	15
LAN	15
VPN	16
Inbound Traffic Management	16
Outbound Policy	16
AP Controller	16
QoS	16
Firewall	17
Captive Portal	17
Other Supported Features	17
Advanced Feature Summary	19
Drop-in Mode and LAN Bypass: Transparent Deployment	19
QoS: Clearer VoIP	19
Per-User Bandwidth Control	20
High Availability via VRRP	20
USB Modem and Android Tethering	21
Built-In Remote User VPN Support	21
LACP NIC Bonding	22
KVM Virtualization	22
DPI Engine	22
NetFlow	23
Wi-Fi Air Monitoring	23
SP Default Configuration	23
SpeedFusion Cloud Relay	23
DNS over HTTPS (DoH)	24

Package Contents	24
Peplink Balance One/Two	24
Peplink Balance 20/30/30 LTE/30 Pro/50	24
Peplink Balance 20X	24
Peplink Balance 210/310	24
Peplink Balance 310X	24
Peplink Balance 310 5G	25
Peplink Balance 310 Fiber 5G	25
Peplink Balance 305/380/580/710/1350/2500	25
Peplink Balance 380X/580X	25
Peplink MediaFast 200	25
Peplink MediaFast 500	26
Peplink EPX	26
Peplink SDX	26
Peplink SDX Pro	26
Peplink Balance Overview	27
Peplink Balance One	27
Panel Appearance	27
LED Indicators	27
Peplink Balance Two	28
Panel Appearance	28
LED Indicators	29
Peplink Balance 20	30
Panel Appearance	30
LED Indicators	30
Peplink Balance 20X	31
Panel Appearance	31
LED Indicators	31
Flex Module Mini	32
Peplink Balance 30 LTE	34
Panel Appearance	34
LED Indicators	34
Peplink Balance 30 Pro	35
Panel Appearance	35
LED Indicators	35
Peplink Balance 50	37

Front Panel Appearance	37
LED Indicators	37
Peplink Balance 210	38
Front Panel Appearance	38
LED Indicators	38
Peplink Balance 305	39
Front Panel Appearance	39
LED Indicators	39
Peplink Balance 310	40
Front Panel Appearance	40
LED Indicators	40
Peplink Balance 310X	41
Front Panel Appearance	41
LED Indicators	41
Peplink Balance 310 5G	43
Front Panel Appearance	43
LED Indicators	43
Peplink Balance 310 Fiber 5G	44
Front Panel Appearance	44
LED Indicators	45
Peplink Balance 380	46
Panel Appearance	46
LED Indicators	46
Peplink Balance 380X	47
Panel Appearance	47
LED Indicators	48
Flex Module Mini	49
Peplink Balance 580	50
Panel Appearance	50
LED Indicators	50
Peplink Balance 580X	51
Panel Appearance	51
LED Indicators	51
Flex Module Mini	52
Peplink Balance 710	53
Front Panel Appearance	53
LED Indicators	54

Peplink Balance 1350	54
Panel Appearance	54
LED Indicators	55
Peplink Balance 2500	56
Panel Appearance	56
LED Indicators	56
Peplink MediaFast Overview	57
Peplink MediaFast 200	57
Panel Appearance	57
LED Indicators	57
Peplink MediaFast 500	59
Panel Appearance	59
LED Indicators	59
Peplink MediaFast 750	60
Panel Appearance	60
LED Indicators	60
Peplink Flex-Module Supported Models	61
Peplink EPX	61
Main Chassis	61
Panel Appearance	62
LED Indicators	63
Peplink SDX	63
Main Chassis	64
Panel Appearance	65
LED Indicators	66
Peplink SDX Pro	67
Main Chassis	67
Panel Appearance	68
LED Indicators	68
Flex Module Expansion Modules	69
8x GE PoE+ Module (EXM-8C)	69
4x SFP+ Module (EXM-4F)	70
3x LTE-A Module (EXM-3LTEA)	71
CAT-18. 2x LTE-A Module (EXM-2GLTE-G)	72
SIM Injector FlexModule (EXM-SIM-BK56)	73
2x 5G Module (EXM-2X5GD)	74

OLED Display Menu	75
Installation	76
Preparation	76
Constructing the Network	76
Basic Configuration	77
Connecting to the Web Admin Interface	77
Configuration with the Setup Wizard	78
SpeedFusion Cloud	83
Activate SpeedFusion Cloud Service	83
Enable SpeedFusion Cloud	86
Connect Clients to Cloud	94
Link Wi-Fi to Cloud	95
Optimize Cloud Application	97
Network Tab	99
WAN	99
Health Check Settings	112
Bandwidth Allowance Monitor Settings	115
Additional Public IP Settings	115
Dynamic DNS Settings	116
LAN	117
Network Settings	118
Network Settings (Common Settings)	122
Port Settings	127
VPN	127
SpeedFusion	128
IPsec VPN	136
GRE Tunnel	140
Outbound Policy	142
Inbound Access	154
Servers	154
Services	155
DNS Settings	158
NAT Mappings	175
MediaFast	177
Setting Up MediaFast Content Caching	177

Viewing MediaFast Statistics	178
Prefetch Schedule	179
ContentHub	182
Configure a website for the ContentHub	182
Configure an application for the ContentHub	184
MDM Settings	187
Docker	187
KVM	187
Captive Portal	189
QoS	191
User Groups	192
Bandwidth Control	192
Application	193
Prioritization for Custom Application	194
DSL/Cable Optimization	194
Firewall	195
Access Rules	195
Intrusion Detection and DoS Prevention	199
Content Blocking	201
Application Blocking	201
Web Blocking	201
Customized Domains	202
Exempted User Groups	202
Exempted Subnets	202
URL Logging	202
Routing Protocols	203
OSPF & RIPv2	203
BGP	205
Remote User Access	210
L2TP with IPsec	210
OpenVPN	210
PPTP	211
Authentication Methods	211
Misc. Settings	212
High Availability	212
Certificate Manager	216
Service Forwarding	217

SMTP Forwarding	218
Web Proxy Forwarding	218
DNS Forwarding	219
Custom Service Forwarding	219
Service Passthrough	220
NTP Server	221
Grouped Networks	221
Remote SIM Management	222
SIM Toolkit	225
AP Tab	227
AP	227
AP Controller	227
Wireless SSID	228
Wireless Mesh	233
AP > Profiles	233
AP Controller Status	237
Info	237
Access Points (Usage)	238
Wireless SSID	241
Wireless Client	241
Mesh / WDS	243
Nearby Device	244
Event Log	244
Toolbox	245
System Tab	246
System	246
Admin Security	246
Firmware	250
Time	252
Schedule	252
Email Notification	254
Event Log	257
SNMP	257
SMS Control	260
InControl	262
Configuration	263

Feature Add-ons	264
Reboot	264
Tools	264
Ping	265
Traceroute	266
Wake-on-LAN	266
WAN Analysis	267
CLI (Command Line) Support	270
Status Tab	271
Status	271
Device	271
Active Sessions	273
Client List	275
WINS Clients	276
OSPF & RIPv2	276
MediaFast	277
PepVPN / SpeedFusion Status	278
Event Log	282
Device Event Log	282
IPsec Event Log	282
WAN Quality	283
Usage Reports	283
Real-Time	283
Hourly	285
Daily	285
Monthly	288
Appendix	288
Restoration of Factory Defaults	289
Routing under DHCP, Static IP, and PPPoE	289
FusionSIM Manual	292
Harrington Industrial Plastics	308
PLUSS	311
Overview of ports used by Peplink SD-WAN routers and other Peplink services	320
Troubleshooting	322

Introduction and Scope

Peplink Balance routers provide link aggregation and load balancing across multiple WAN connections. We develop products and technologies that can help you build SD-WAN networks with unbreakable connection resilience, unmatched deployment flexibility, and intuitive ease of use.

Our product and technology focus has always been on WAN virtualization and the intelligent use of multiple WAN links at the same time to increase reliability and bandwidth whilst reducing costs.

We have two key WAN virtualization technologies, Intelligent load balancing for Internet access and SpeedFusion VPN Bonding for secure branch to branch connectivity.

The Peplink MediaFast series are a range of routers capable of content caching.

Designed with education and entertainment in mind, MediaFast downloads and accelerates video, iTunes iOS updates, app downloads, and other content for uninterrupted learning and fun anytime.

The MediaFast can prefetch content during off-peak hours, saving connectivity costs and reducing network burden during busy times.

This manual applies to the following Peplink Balance products:

- Peplink Balance One
- Peplink Balance Two
- Peplink Balance 20
- Peplink Balance 20X
- Peplink Balance 30 LTE/Pro
- Peplink Balance 210
- Peplink Balance 310
- Peplink Balance 310X
- Peplink Balance 310 5G
- Peplink Balance 310 Fiber 5G
- Peplink Balance 380
- Peplink Balance 380X
- Peplink Balance 580
- Peplink Balance 580X
- Peplink Balance 710
- Peplink Balance 1350
- Peplink Balance 2500
- Peplink MediaFast 200/500/750
- Peplink EPX
- Peplink SDX
- Peplink SDX Pro

The manual covers setting up your Peplink Balance or MediaFast and provides a collection of case studies detailing the advanced features of the Peplink Balance.

1 Glossary

The following terms, acronyms, and abbreviations are frequently used in this manual:

Term	Definition
3G	3rd generation standards for wireless communications (e.g., HSDPA)
4G	4th generation standards for wireless communications (e.g., LTE)
DHCP	Dynamic Host Configuration Protocol
DNS	Domain Name System
EVDO	Evolution-Data Optimized
FQDN	Fully Qualified Domain Name
HSDPA	High-Speed Downlink Packet Access
HTTP	Hyper-Text Transfer Protocol
ICMP	Internet Control Message Protocol
IP	Internet Protocol
LAN	Local Area Network
MAC Address	Media Access Control Address
MTU	Maximum Transmission Unit
MSS	Maximum Segment Size
NAT	Network Address Translation
PPPoE	Point to Point Protocol over Ethernet
QoS	Quality of Service
SNMP	Simple Network Management Protocol
TCP	Transmission Control Protocol
UDP	User Datagram Protocol
VPN	Virtual Private Network
VRF	Virtual Routing and Forwarding
VRRP	Virtual Router Redundancy Protocol
WAN	Wide Area Network
WINS	Windows Internet Name Service
WLAN	Wireless Local Area Network
210+	Refers to Peplink Balance 210/310/380/580/710/1350/2500
380+	Refers to Peplink Balance 380/580/710/1350/2500

2 Product Comparison Charts

2.1 Balance Routers (for Small Office / Branch)

	20	20X	30 LTE	30 PRO	ONE	TWO	210	310X
Product Code	BPL-021	BPL-021X-LTE	BPL-031-LTE	BPL-031-LTEA	BPL-ONE	BPL-TWO	BPL-210	BPL-310X
Capacity								
Ethernet WAN Ports	2 (GE) +	1 (GE)	2 (GE)	2 (GE)	2/5 (GE) #	2 (GE)	2 (GE) +	2 (GE)
LAN Ports	4 (GE)	4 (GE)	4 (GE)	4 (GE)	8/5 (GE) #	4 (GE)	7 (GE)	9 (GE)
Simultaneous Dual-Band 802.11ac/a/b/g/n Wi-Fi AP	No	Yes	No	Yes	Yes	No	No	No
Embedded 4G LTE	No	Yes	Yes	Yes	No	No	No	Yes
SIM Card Size	No	Mini-SIM (2FF)	Mini-SIM (2FF)	Mini-SIM (2FF)	No	No	No	Mini-SIM (2FF)
USB WAN Modem Port	1	1	1	1	1	1	1	2
Recommended Users	1-60	1-60	1-60	1-60	1-60	25-150	25-150	50-500
Stateful Firewall Throughput	150Mbps	900Mbps	200Mbps	400Mbps	600Mbps/400Mbps #	1Gbps	350Mbps	2.5Gbps

A full product comparison for Balance routers is available at:
<http://www.peplink.com/products/balance/model-comparison/>

2.2 Balance Routers (for for Enterprise / Headquarters)

	305	310X	380	380X	580	580X	710	1350	2500
Product Code	BPL-305	BPL-310X	BPL-380	BPL-380X	BPL-580	BPL-580X	BPL-710	BPL-135	BPL-2500*
Capacity									
Ethernet WAN Ports	3 (GE)	2 (GE)	3 (GE)	3 (GE)	5 (GE)	5 (GE)	<u>7 (GE)</u>	13 (GE)	12 (GE)/4 (GE) & 2 (10G SFP+)*
LAN Ports	3 (GE)	9 (GE)	3 (GE)	3 (GE)	3 (GE)	3 (GE)	3 (GE)	3 (GE)	8 (GE)/2 (10G SFP+)*
Simultaneous Dual-Band 802.11ac/a/b/g /n Wi-Fi AP	No	No	No	No	No	No	No	No	No
Embedded 4G LTE	No	Yes	No	No	No	No	No	No	No
SIM Card Size	No	Yes	No	No	No	No	No	No	No
USB WAN Modem Port	1	2	1	1	1	1	1	1	1
Recommended Users	50-500	50-500	50-500	50-500	300-1000	300-1000	500-2000	1000-5000	5000-20000+
Stateful Firewall Throughput	1Gbps	2.5Gbps	1Gbps	3Gbps	1.5Gbps	4Gbps1	2.5Gbps	5Gbps	8Gbps

A full product comparison for Balance routers is available at:
<http://www.peplink.com/products/balance/model-comparison/>

2.3 MediaFast Routers

	MediaFast 200	MediaFast 500	MediaFast 750
Product Code	MFA-200-W	MFA-500-B	MFA-750-B
WAN Interface	2x GE (Only WAN 1 is activated.)	5x GE	7x GE
Wi-Fi Interface	Simultaneous Dual-Band 802.11a/b/g/n Access Point	-	-
Embedded 3G/4G LTE	-	-	-
USB WAN Modem	1	1	1
LAN Interface	8x GE; 802.3at PoE Output	3x GE	3x GE
Recommended Users	25-150	300-1000	500-2000
Router Throughput	200Mbps	800Mbps	1.5Gbps
Disk Drive	120GB SSD	500GB SSD	1TB SSD
Load Balancing & Failover	Yes	Yes	Yes
PepVPN	Yes	Yes	Yes
SpeedFusion Hot Failover	Optional Feature	Yes	Yes
SpeedFusion WAN Smoothing	Optional Feature	Yes	Yes
SpeedFusion Bandwidth Bonding	Optional Feature	Yes	Yes
Number of PepVPN/SpeedFusion Peers	2	50	300
PepVPN/ SpeedFusion Throughput	50Mbps	200Mbps	400Mbps
Built-in AP Controller	Yes	Yes	Yes
Maximum Number of AP Support	50	100	250
PoE Input	-	-	-
PoE Output	8x 802.3at (optional feature)	-	-
Dimensions	292 x 177 x 44 mm	431 x 305 x 44 mm	426 x 365 x 44 mm
Gross Weight	2.8 kg	6.6 kg	5.5 kgs

A full product comparison for MediaFast routers is available at:

<https://www.peplink.com/products/mediafast-specifications/>

3 Product Features

Peplink Balance Series products enable all LAN users to share broadband Internet connections and provide advanced features to enhance Internet access. The following is a list of supported features:

WAN

- Multiple public IP support (DHCP, PPPoE, static IP address)
- Static IP support for PPPoE
- 10/100/1000Mbps Ethernet connection in full/half duplex
- Built-in HSPA and EVDO cellular modems
- USB mobile connection (**only one USB modem can be connected at a time**)
- Drop-in mode on selectable WAN port with MAC address passthrough network address translation (NAT) / port address translation (PAT)
- Inbound and outbound NAT mapping
- Multiple static IP addresses per WAN connection
- MAC address clone
- Customizable MTU and MSS values
- WAN connection health check
- Dynamic DNS (supported service providers: changeip.com, dyndns.org, no-ip.org, tzo.com, and DNS-O-Matic)
- Ping, DNS lookup, and HTTP-based health check
- WAN throughput and consistency diagnosis
- WAN to WAN speed test
- USB Ethernet Adapter support

LAN

- DHCP server on LAN
- Extended DHCP option support
- Static routing rules
- Local DNS proxy server
- 802.1q VLANs
- Port-based VLANs
- Virtual Network Mapping

VPN

- Secure SpeedFusion™
- SpeedFusion performance analyzer
- X.509 certificate support
- Bandwidth bonding and failover among selected WAN connections
- Ability to route traffic to a remote VPN peer
- Optional pre-shared key setting
- Layer 2 bridging
- Layer 2 Peer Isolation
- SpeedFusion™ throughput, ping, and traceroute tests
- Built-in L2TP / PPTP / OpenVPN VPN server
- Authenticate L2TP / PPTP clients using RADIUS and LDAP servers
- Multi-Site PepVPN Profile
- IPsec VPN for network-to-network connections
- L2TP / PPTP and IPsec passthrough
- Simultaneous L2 & L3 VPN tunnel between the same pair of devices

Inbound Traffic Management

- TCP/UDP traffic redirection to dedicated LAN server(s)
- Inbound link load balancing by means of DNS

Outbound Policy

- Link load distribution per TCP/UDP service
- Persistent routing for specified source and/or destination IP addresses per TCP/UDP service
- Prioritize and route traffic to VPN tunnels with Priority and Enforced algorithms
- Time-based scheduling

AP Controller

- Configure and manage Pepwave AP devices
- Review the status of connected AP

QoS

- Quality of service for different applications and custom protocols
- User group classification for different service levels
- Bandwidth usage control and monitoring on group- and user-level
- Application prioritization for custom protocols and DSL optimization

Firewall

- Outbound (LAN to WAN) firewall rules
- Inbound (WAN to LAN) firewall rules per WAN connection
- Intrusion detection and prevention
- Specification of NAT mappings
- Web blocking
- Application blocking
- Time-based scheduling
- Outbound firewall rules can be defined by destination domain name

Captive Portal

- Social Wi-Fi Hotspot Support
- Splash screen of open networks, login page for secure networks
- Customizable built-in captive portal
- Supports linking to outside page for captive portal

Other Supported Features

- Easy-to-use web administration interface
- HTTP and HTTPS support for web administration interface
- Configurable web administration port and administrator password
- Read-only user for web admin
- Shared-IP drop-in mode
- Authentication and accounting by RADIUS server for web admin
- Firmware upgrades, configuration backups, ping, and traceroute via web administration interface
- Remote web-based configuration (via WAN and LAN interfaces)
- Remote reporting to Peplink Balance reporting server
- Hardware high availability via VRRP, with automatic configuration synchronization
- Real-time, hourly, daily and monthly bandwidth usage reports and charts
- Hardware backup via LAN bypass
- Built-in WINS server
- Time server synchronization
- SNMP
- Email notification
- Syslog
- SIP passthrough
- PPTP packet passthrough
- Active sessions
- Active client list

- WINS client list
- UPnP / NAT-PMP
- Event log is persistent across reboots
- IPv6 support
- Support for USB tethering on Android phones

4 Advanced Feature Summary

4.1 Drop-in Mode and LAN Bypass: Transparent Deployment



As your organization grows, it may require more bandwidth, but modifying your network can be tedious. In **Drop-in Mode**, you can conveniently install your Peplink router without making any changes to your network. For any reason your Peplink router loses power, the **LAN Bypass** will safely and automatically bypass the Peplink router to resume your original network connection.

4.2 QoS: Clearer VoIP



VoIP and videoconferencing are highly sensitive to latency. With QoS, Peplink routers can detect VoIP traffic and assign it the highest priority, giving you crystal-clear calls.

4.3 Per-User Bandwidth Control

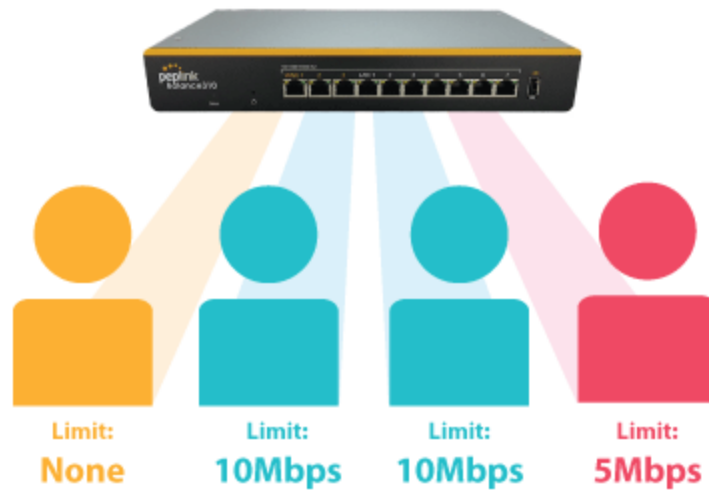

With per-user bandwidth control, you can define bandwidth control policies for up to 3 groups of users to prevent network congestion. Define groups by IP address and subnet, and set bandwidth limits for every user in the group.

4.4 High Availability via VRRP



When your organization has a corporate requirement demanding the highest availability with no single point of failure, you can deploy two Peplink routers in [High Availability mode](#). With High Availability mode, the second device will take over when needed.

4.5 USB Modem and Android Tethering



For increased WAN diversity, plug in a USB LTE modem as backup. Peplink routers are compatible with over 200 modem types. You can also tether to smartphones running Android 4.1.X and above.

By default, the USB port is “USB Modem” mode. If you need to use it to connect to USB Ethernet Adapter, you need to change it to “USB Ethernet” mode,

<https://forum.peplink.com/t/can-i-use-ethernet-adapters-on-the-usb-wan/8327>

4.6 Built-In Remote User VPN Support



Use OpenVPN or L2TP with IPsec to safely and conveniently connect remote clients to your private network. L2TP with IPsec is supported by most devices, but legacy devices can also connect using PPTP.

[Click here for the full instructions on setting up L2TP with IPsec.](#)

[Click here for the full instructions on setting up OpenVPN connections](#)

4.7 LACP NIC Bonding



Use 802.3ad to combine multiple LAN connections into a virtual LAN connection. This virtual connection has higher throughput and redundancy in case any single link fails.

4.8 KVM Virtualization

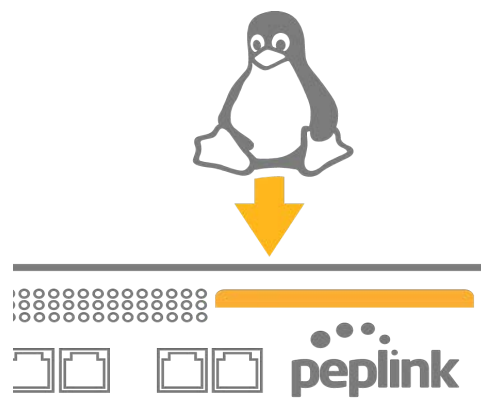

KVM is a virtualisation module that allows administrators using our routers to host a large range of virtual machines. KVM is now supported by some of the MediaFast / ContentHub routers.

[Click here for the full instructions on how to set up KVM](#)

[Click here for the full instructions on how to set up KVM with USB Storage](#)

4.9 DPI Engine

The DPI report written in the updated KB article will show further information on InControl2 through breaking down application categories into subcategories.

<https://forum.peplink.com/t/updated-ic2-deep-packet-inspection-dpi-reports-and-everything-you-need-to-know-about-it/29658>

4.10 NetFlow

NetFlow protocol is used to track network traffic. Tracking information from NetFlow can be sent to the NetFlow collector, which analyzes data and generates reports for review.

Note: To enable this feature, go to <https://<Device's IP>/cgi-bin/MANGA/support.cgi>

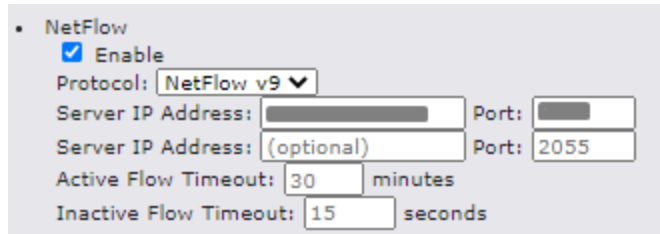

4.11 Wi-Fi Air Monitoring

Peplink routers support Wi-Fi “Air Monitoring Mode” which is used to troubleshoot remotely and proactively monitor Wi-Fi and WAN performance. After enabling Wi-Fi Air Monitoring, reports can be viewed under **InControl 2 > Reports > AirProbe Reports**.

Note: To enable this feature, go to <https://<Device's IP>/cgi-bin/MANGA/support.cgi>

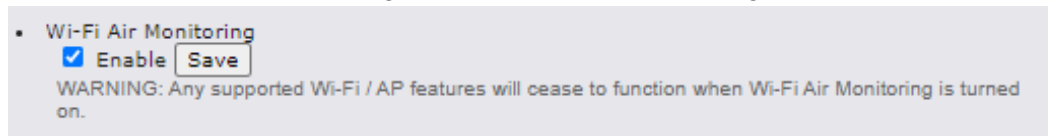

4.12 SP Default Configuration

The SP Default Configuration feature written in the updated KB article allows for the provisioning of custom made settings (a.k.a. InControl2 configuration) via the Ethernet LAN port and is ideal for those wanting to do a bulk deployment of many Peplink devices.

Note: If you would like to use this feature, please contact your purchase point (Eg.VAD).

4.13 SpeedFusion Cloud Relay

Cloud Service Providers often restrict access to certain applications. With SFC Relay, you can route traffic before going out to the Internet, allowing access to previously restricted applications experienced with the public SpeedFusion Cloud nodes. Available as an add-on for your home router or as an upgradable license to your Peplink router, SFC Relay is sure to impress you and any peers you give access to.

<https://forum.peplink.com/t/configure-speedfusion-cloud-relay-server-and-client/6215ca9b017e48e0f3ff2479/>

4.14 DNS over HTTPS (DoH)

DoH provides the benefits of communicating DNS information over a secure HTTPS connection in an encrypted manner. The protocol offers increased privacy and confidentiality by preventing data interception and man-in-the-middle attacks.

5 Package Contents

The contents of Peplink Balance product packages are as follows:

5.1 Peplink Balance One/Two

- Peplink Balance One/Two
- Power adapter
- Information slip

5.2 Peplink Balance 20/30/30 LTE/30 Pro/50

- Peplink Balance 20/30/30 LTE/30 Pro/50
- Power adapter
- Information slip

5.3 Peplink Balance 20X

- Peplink Balance 20X
- 2x LTE Antenna, 1x GPS Antenna, 2x Wi-Fi Antenna
- Power adapter
- Information slip

5.4 Peplink Balance 210/310

- Peplink Balance 210/310
- Power adapter
- Information slip
- Rackmount kit

5.5 Peplink Balance 310X

- Peplink Balance 310X
- 2x LTE Antenna, 1x GPS Antenna

- Power adapter
- Ear L-Mounts kit
- Power cord

5.6 Peplink Balance 310 5G

- Balance 310 5G
- Power adapter
- Power cord
- 4x Rubber foot
- 6x Cellular Antenna

5.7 Peplink Balance 310 Fiber 5G

- Balance 310 Fiber 5G
- Power adapter
- Power cord
- 4x Rubber foot
- 4x Cellular Antenna
- 4x Wi-Fi Antenna

5.8 Peplink Balance 305/380/580/710/1350/2500

- Peplink Balance 305/380/580/710/1350/2500
- Power cord
- Information slip
- Rackmount kit

5.9 Peplink Balance 380X/580X

- Peplink 380X/580X
- Power cord
- 1 Pair of Mounting Brackets

5.10 Peplink MediaFast 200

- Peplink MediaFast 200
- Power adapter
- Information slip

5.11 Peplink MediaFast 500

- Peplink MediaFast 500
- Power cord
- Information slip
- Rackmount kit

5.12 Peplink EPX

- Wireless SD-WAN Powerhouse
- EPX Chassis with OLD
- Optional x LTE-A modules
- Optional x Copper ETH module
- Optional x Fiber ETH module
- Rack mounting kit with brackets and slide

5.13 Peplink SDX

- SDX Base Chassis
- 1U 19" Rackmount Chassis

5.14 Peplink SDX Pro

- SDX Pro Base Chassis
- 1U 19" Rack-mount Chassis
- 1x Rubber Foot Pack
- 2x Power Cords
- 1x L-mount Set

6 Peplink Balance Overview

6.1 Peplink Balance One

6.1.1 Panel Appearance

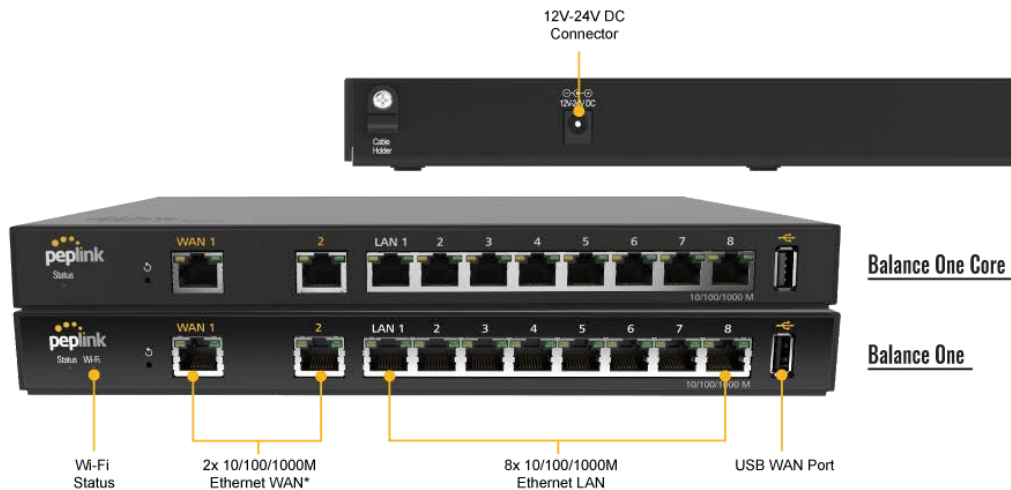

*If the WAN Activation License (BPL-ONE-LC-5WAN) is activated, router throughput will be changed to 400Mbps, both number of WAN and LAN will become 5.

6.1.2 LED Indicators

The statuses indicated by the front panel LEDs are as follows:

Power and Status Indicators	
Status	OFF – Upgrading firmware
	Red – Booting up or busy
	Blinking red – Boot up error
	Green – Ready

LAN and WAN Ports	
Green LED	ON – 1000 Mbps
	OFF – 10 / 100 Mbps or port is not connected
Orange LED	Blinking – Data is transferring
	OFF – No data is being transferred or port is not connected
Port Type	Auto MDI/MDI-X ports

Wi-Fi Indicators		
Wi-Fi	OFF	Disabled
	Green	Ready

USB Port	
USB Ports	For future functionality

6.2 Peplink Balance Two

6.2.1 Panel Appearance

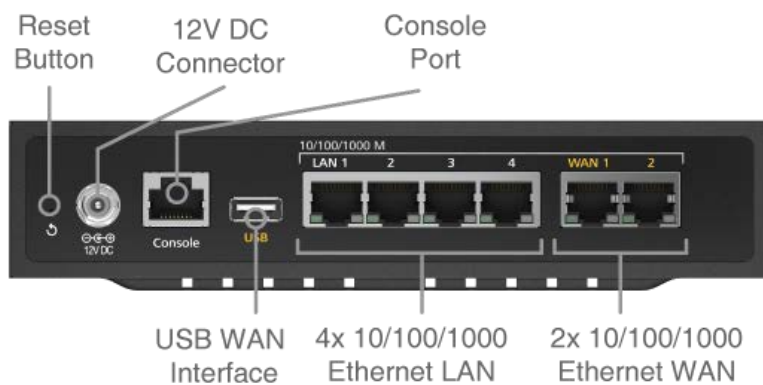

6.2.2 LED Indicators

The statuses indicated by the front panel LEDs are as follows:

Power and Status Indicators	
Power	OFF – Power off
	Green – Power on
Status	OFF – Upgrading firmware
	Red – Booting up or busy
	Blinking red – Boot up error
	Green – Ready

LAN and WAN Ports	
Green LED	ON – 1000 Mbps
	OFF – 10 / 100 Mbps or port is not connected
Orange LED	Blinking – Data is transferring
	OFF – No data is being transferred or port is not connected
Port Type	Auto MDI/MDI-X ports

USB Port	
USB Ports	For connecting a 4G/3G USB modem

6.3 Peplink Balance 20

6.3.1 Panel Appearance

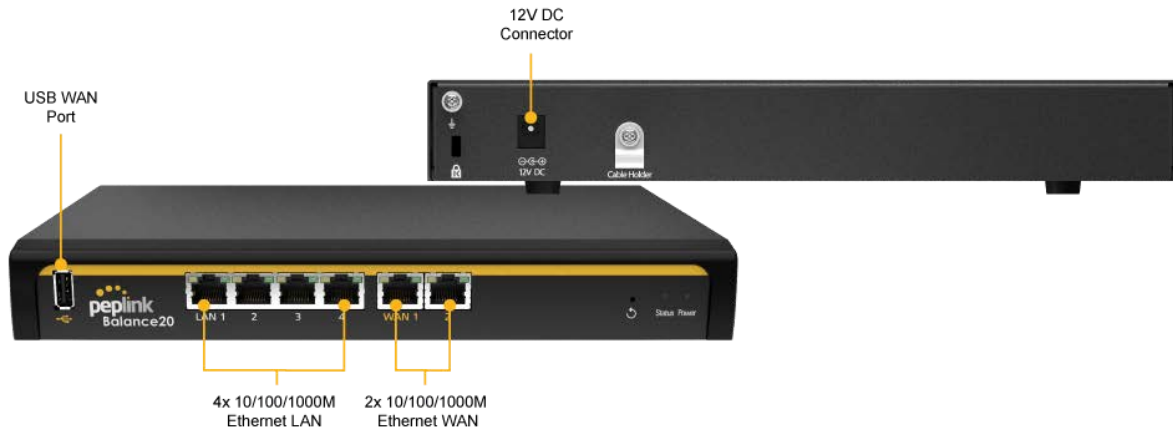

6.3.2 LED Indicators

The statuses indicated by the front panel LEDs are as follows:

Power and Status Indicators	
Power	OFF – Power off
	Green – Power on
Status	OFF – Upgrading firmware
	Red – Booting up or busy
	Blinking red – Boot up error
	Green – Ready

LAN and WAN Ports	
Green LED	ON – 10 / 100 / 1000 Mbps
Orange LED	Blinking – Data is transferring
	OFF – No data is being transferred or port is not connected
Port Type	Auto MDI/MDI-X ports

USB Port	
USB Ports	For connecting a 4G/3G USB modem

6.4 Peplink Balance 20X

6.4.1 Panel Appearance

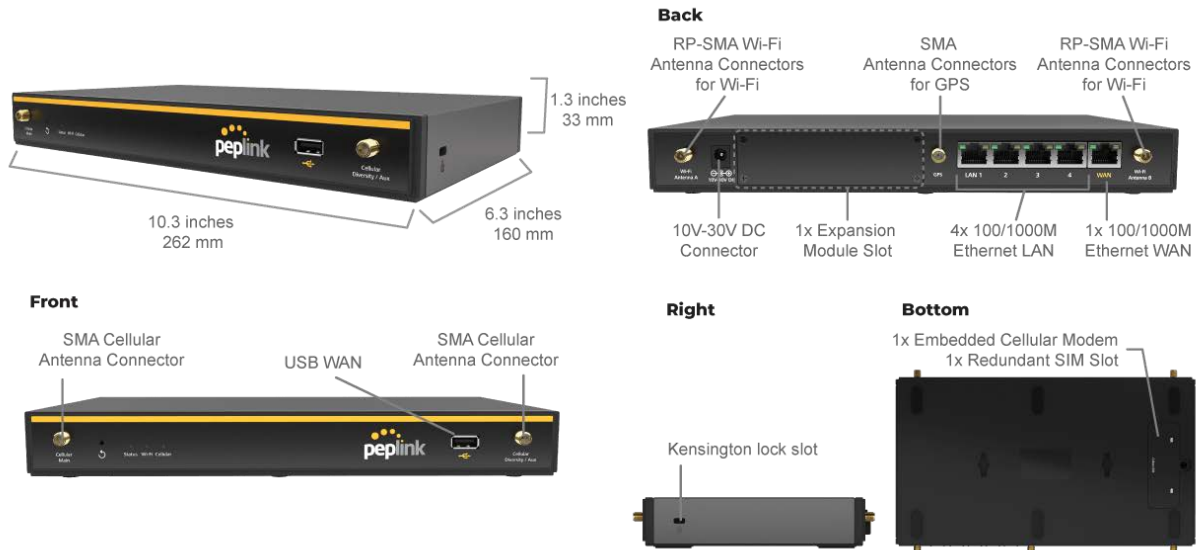

6.4.2 LED Indicators

The statuses indicated by the front panel LEDs are as follows:

Power and Status Indicators	
Status	OFF – Upgrading firmware
	Red – Booting up or busy
	Blinking red – Boot up error
	Green – Ready

LAN and WAN Ports	
Green LED	ON – 1000 Mbps
	OFF – 10 / 100 Mbps or port is not connected
Orange LED	Blinking – Data is transferring
	OFF – No data is being transferred or port is not connected
Port Type	Auto MDI/MDI-X ports

Wi-Fi AP Indicators		
Wi-Fi AP	OFF	Disabled
	ON	Enabled

USB Port	
USB Ports	For connecting a 4G/3G USB modem

6.4.3 Flex Module Mini



1x LTE-A Module	
Interface	1x Embedded LTE-A Cellular Modems with Redundant SIM Slots
Antenna Connectors	2x SMA Cellular Antenna Connectors
Downlink / Uplink Datarate	300Mbps/50Mbps (CAT-6) 600Mbps/150Mbps (CAT-12)
Power Consumption	10W
Weight	0.83 pounds 375 grams



1xLTE-A Module	
Interface	1x Embedded LTE-A Cellular Modems with Redundant SIM Slots
Antenna Connectors	4x SMA Cellular Antenna Connectors
Downlink / Uplink Datarate	1.2 Gbps/150 Mbps (CAT-18)
Power Consumption	10W
Weight	0.83 pounds 375 grams



1x VDSL Module	
Interface	1x RJ11 Connector, 1x Status LED
Power Consumption	9W
Weight	0.44 pounds 200 grams

6.5 Peplink Balance 30 LTE

6.5.1 Panel Appearance

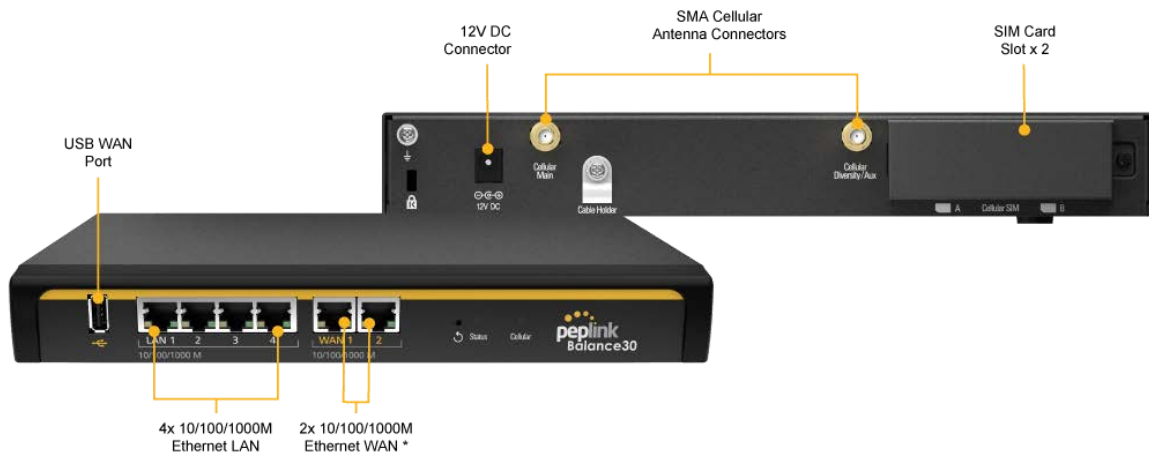

* WAN ports can act as a LAN port if needed.

6.5.2 LED Indicators

The statuses indicated by the front panel LEDs are as follows:

Power and Status Indicators	
Power	OFF – Power off
	Green – Power on
Status	OFF – Upgrading firmware
	Red – Booting up or busy
	Blinking red – Boot up error
	Green – Ready

LAN and WAN Ports	
Green LED	ON – 10 / 100 /1000 Mbps
Orange LED	Blinking – Data is transferring
	OFF – No data is being transferred or port is not connected
Port Type	Auto MDI/MDI-X ports

Cellular WAN Indicators		
Cellular	OFF	Disabled
	Blinking slowly	Connecting to wireless network
	ON	Connected to wireless network

USB Port	
USB Ports	For connecting a 4G/3G USB modem

6.6 Peplink Balance 30 Pro

For certification information, please refer to Appendix F (page 327 ~ 330)

6.6.1 Panel Appearance

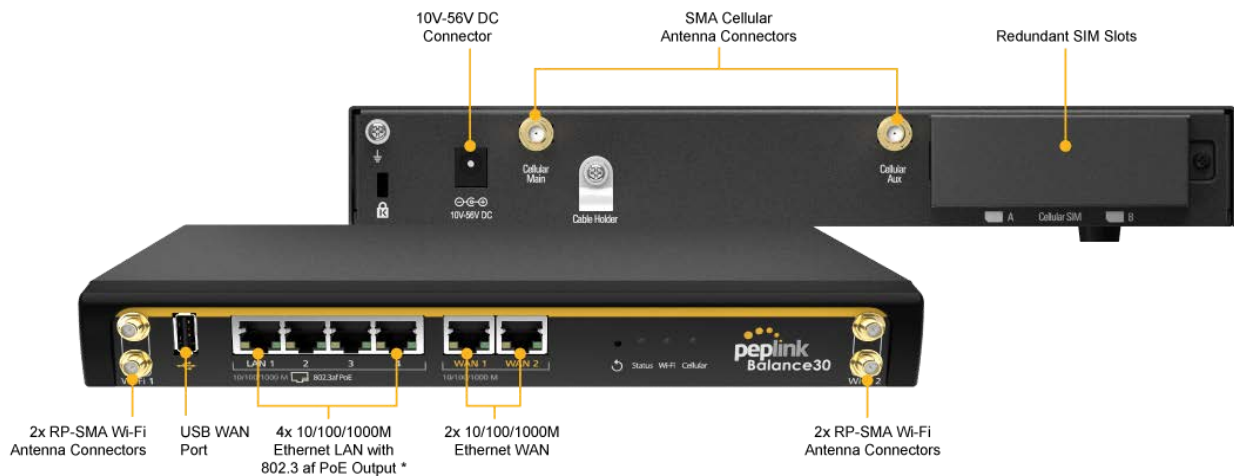

* PoE Activation Kit is available separately, needs at least 48V of input for PoE output

6.6.2 LED Indicators

The statuses indicated by the front panel LEDs are as follows:

Power and Status Indicators	
Power	OFF – Power off
	Green – Power on

Status	OFF – Upgrading firmware
	Red – Booting up or busy
	Blinking red – Boot up error
	Green – Ready

WAN Ports	
Green LED	ON – 1000 Mbps OFF -10 / 100 Mbps or port is not connected
Orange LED	Blinking – Data is transferring OFF – No data is being transferred or port is not connected
Port Type	Auto MDI/MDI-X ports

LAN Ports	
Green LED	ON – POE Enabled OFF - POE Disabled
Orange LED	Blinking – 10 / 100 / 1000 Mbps with activity OFF – No data is being transferred or port is not connected
Port Type	Auto MDI/MDI-X ports

Wi-Fi AP Indicators		
Wi-Fi AP	OFF	Disabled
	ON	Enabled

Cellular WAN Indicators		
Cellular	OFF	Disabled
	Blinking slowly	Connecting to wireless network
	ON	Connected to wireless network

USB Port	
USB Ports	For connecting a 4G/3G USB modem

6.7 Peplink Balance 50

6.7.1 Front Panel Appearance

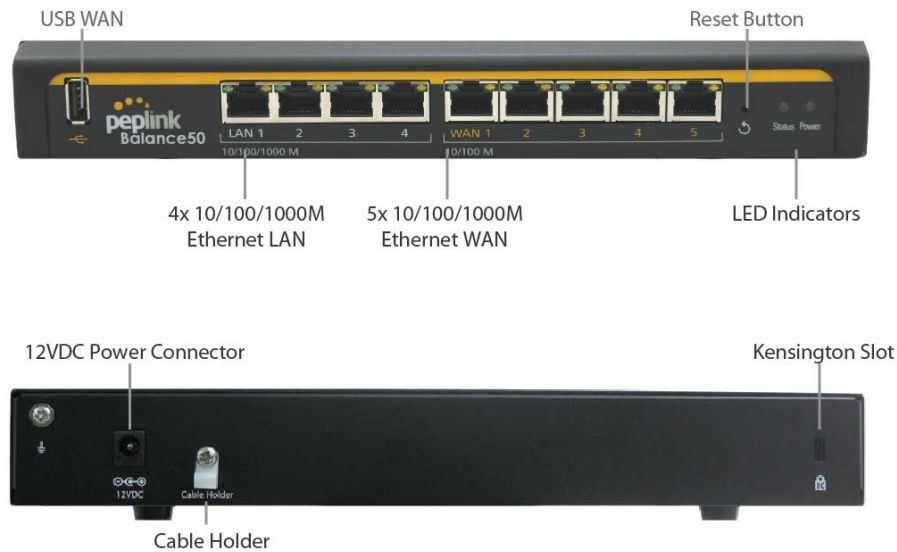

6.7.2 LED Indicators

The statuses indicated by the front panel LEDs are as follows:

Power and Status Indicators	
Power	OFF – Power off
	Green – Power on
Status	OFF – Upgrading firmware
	Red – Booting up or busy
	Blinking red – Boot up error
	Green – Ready

LAN and WAN Ports	
Green LED	ON – 10 / 100 /1000 Mbps
Orange LED	Blinking – Data is transferring
	OFF – No data is being transferred or port is not connected
Port Type	Auto MDI/MDI-X ports

USB Port	
USB Ports	For connecting a 4G/3G USB modem

6.8 Peplink Balance 210

6.8.1 Front Panel Appearance

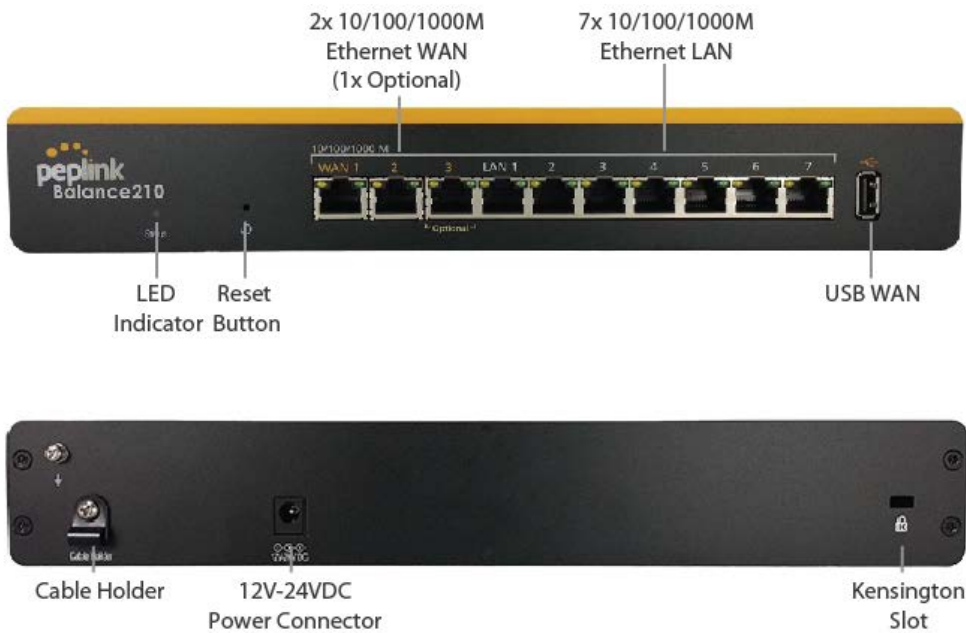

6.8.2 LED Indicators

The statuses indicated by the front panel LEDs are as follows:

Power and Status Indicators	
Status	OFF – Upgrading firmware
	Red – Booting up or busy
	Blinking red – Boot up error
	Green – Ready

LAN and WAN Ports	
Green LED	ON – 10 / 100 / 1000 Mbps
Orange LED	Blinking – Data is transferring
	OFF – No data is being transferred or port is not connected
Port Type	Auto MDI/MDI-X ports

USB Port	
USB Ports	For connecting a 4G/3G USB modem

6.9 Peplink Balance 305

6.9.1 Front Panel Appearance

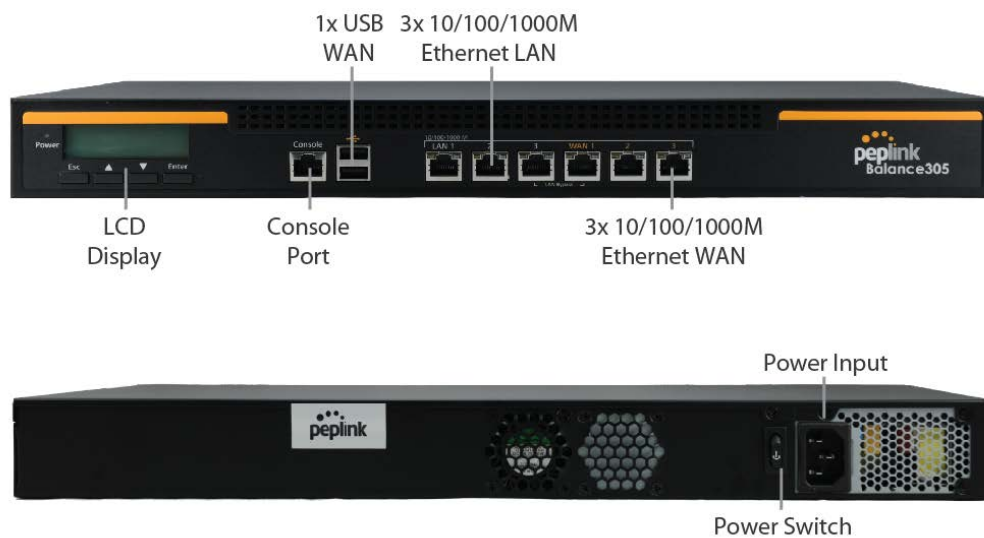

6.9.2 LED Indicators

The statuses indicated by the front panel LEDs are as follows:

Power and Status Indicators	
Power LED	OFF – Power off
	GREEN – Power on

LAN Port, WAN 1 – 3 Ports	
Right LED	ORANGE – 1000 Mbps
	GREEN – 100 Mbps
	OFF – 10 Mbps
Left LED	Solid – Port is connected without traffic
	Blinking – Data is transferring
	OFF – Port is not connected
Port Type	Auto MDI/MDI-X ports

Console and USB Ports	
Console Port	Reserved for engineering use
USB Ports	For connecting a 4G/3G USB modem

6.10 Peplink Balance 310

6.10.1 Front Panel Appearance

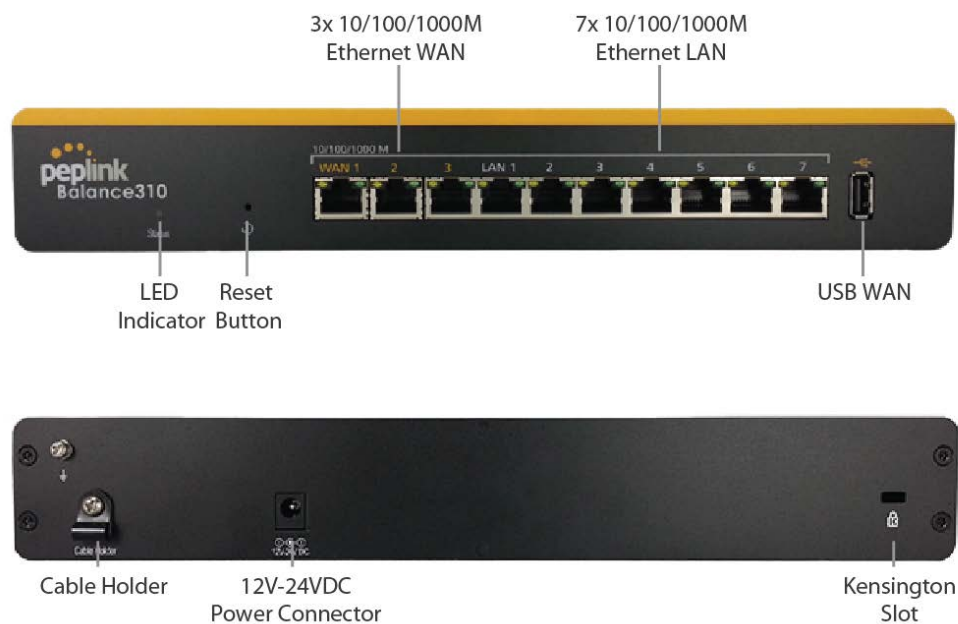

6.10.2 LED Indicators

The statuses indicated by the front panel LEDs are as follows:

Power and Status Indicators	
Status	OFF – Upgrading firmware
	Red – Booting up or busy
	Blinking red – Boot up error
	Green – Ready

LAN and WAN Ports	
Green LED	ON – 10 / 100 / 1000 Mbps
Orange LED	Blinking – Data is transferring
	OFF – No data is being transferred or port is not connected
Port Type	Auto MDI/MDI-X ports

USB Port	
USB Ports	For connecting a 4G/3G USB modem

6.11 Peplink Balance 310X

6.11.1 Front Panel Appearance

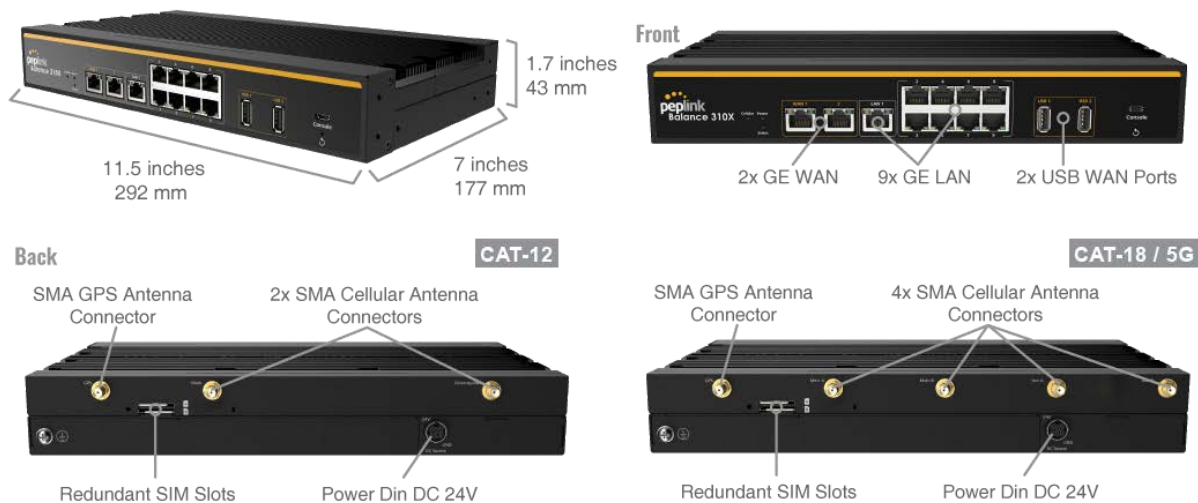

6.11.2 LED Indicators

The statuses indicated by the front panel LEDs are as follows:

Power and Status Indicators	
Power	OFF – Power off
	Green – Power on
Status	OFF – Upgrading firmware
	Red – Booting up or busy
	Blinking red – Boot up error
	Green – Ready

WAN Ports	
Green LED	ON - 1000 Mbps
	OFF – 10 / 100 Mbps or port is not connected
Orange LED	Blinking – Data is transferring
	OFF – No data is being transferred or port is not connected
Port Type	Auto MDI/MDI-X ports

LAN Ports	
Green LED	ON – 1000 Mbps
	OFF – 10 / 100 Mbps or port is not connected
Orange LED	Blinking – 10 / 100 / 1000 Mbps with activity
	OFF – No data is being transferred or port is not connected
Port Type	Auto MDI/MDI-X ports

Cellular WAN Indicators		
Cellular	OFF	Disabled
	Blinking slowly	Connecting to wireless network
	ON	Connected to wireless network

Wi-Fi AP Indicators		
Wi-Fi AP	OFF	Disabled
	ON	Enabled

USB Port	
USB Ports	For connecting a 4G/3G USB modem

6.12 Peplink Balance 310 5G

6.12.1 Front Panel Appearance

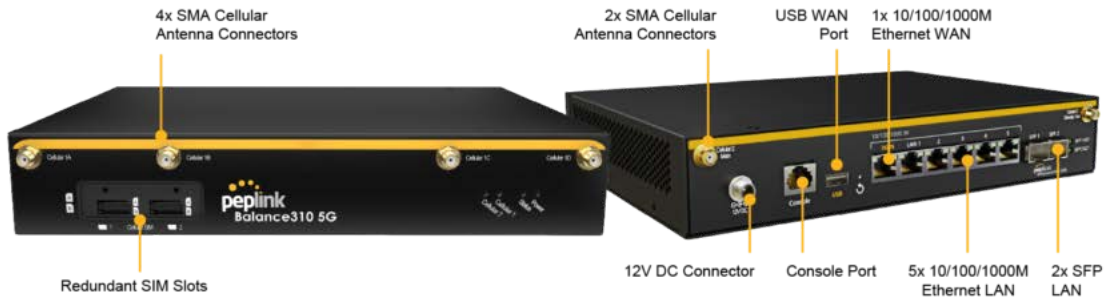

6.12.2 LED Indicators

The statuses indicated by the front panel LEDs are as follows:

Power and Status Indicators	
Power	OFF – Power off
	Green – Power on
Status	OFF – Upgrading firmware
	Red – Booting up or busy
	Blinking red – Boot up error
	Green – Ready

WAN Port	
Right LED	GREEN - 1000 Mbps
	ORANGE - 100 Mbps
	OFF – 10 Mbps or port is not connected
Left LED	Blinking – Data is transferring
	OFF – Port is not connected
Port Type	Auto MDI/MDI-X ports

LAN Ports	
Right LED	<p>GREEN – 1000 Mbps</p> <p>ORANGE - 100 Mbps</p> <p>OFF – 10 Mbps or port is not connected</p>
Left LED	<p>Blinking – Data is transferring</p> <p>OFF – Port is not connected</p>
Port Type	Auto MDI/MDI-X ports

Cellular WAN Indicators							
Cellular	<table border="1"> <tr> <td>OFF</td> <td>Disabled</td> </tr> <tr> <td>Blinking slowly</td> <td>Connecting to wireless network</td> </tr> <tr> <td>ON</td> <td>Connected to wireless network</td> </tr> </table>	OFF	Disabled	Blinking slowly	Connecting to wireless network	ON	Connected to wireless network
OFF	Disabled						
Blinking slowly	Connecting to wireless network						
ON	Connected to wireless network						

USB Port	
USB Ports	For connecting a 4G/3G USB modem

6.13 Peplink Balance 310 Fiber 5G

6.13.1 Front Panel Appearance

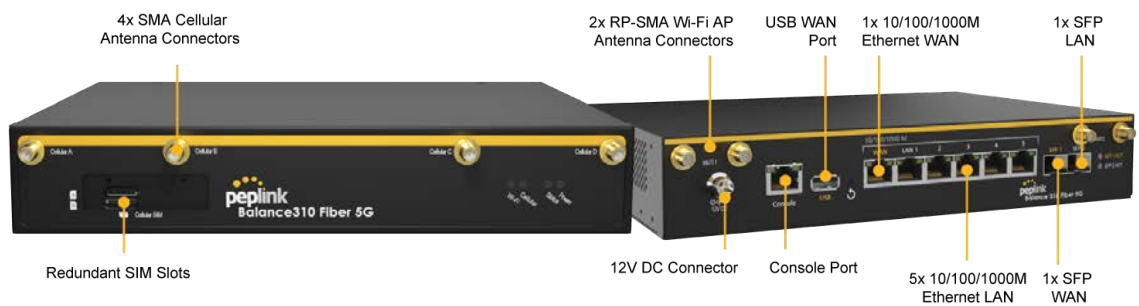

6.13.2 LED Indicators

The statuses indicated by the front panel LEDs are as follows:

Power and Status Indicators	
Power	OFF – Power off
	Green – Power on
Status	OFF – Upgrading firmware
	Red – Booting up or busy
	Blinking red – Boot up error
	Green – Ready

WAN Port	
Right LED	Green - 1000 Mbps
	Orange - 100 Mbps
	OFF – 10 Mbps or port is not connected
Left LED	Blinking – Data is transferring
	OFF – Port is not connected
Port Type	Auto MDI/MDI-X ports

LAN Ports	
Right LED	Green – 1000 Mbps
	Orange - 100 Mbps
	OFF – 10 Mbps or port is not connected
Left LED	Blinking – Data is transferring
	OFF – Port is not connected
Port Type	Auto MDI/MDI-X ports

Cellular WAN Indicators		
Cellular	OFF	Disabled
	Blinking slowly	Connecting to wireless network
	ON	Connected to wireless network

Wi-Fi AP Indicators		
Wi-Fi AP	OFF	Disabled
	ON	Enabled

USB Port	
USB Ports	For connecting a 4G/3G USB modem

6.14 Peplink Balance 380

6.14.1 Panel Appearance

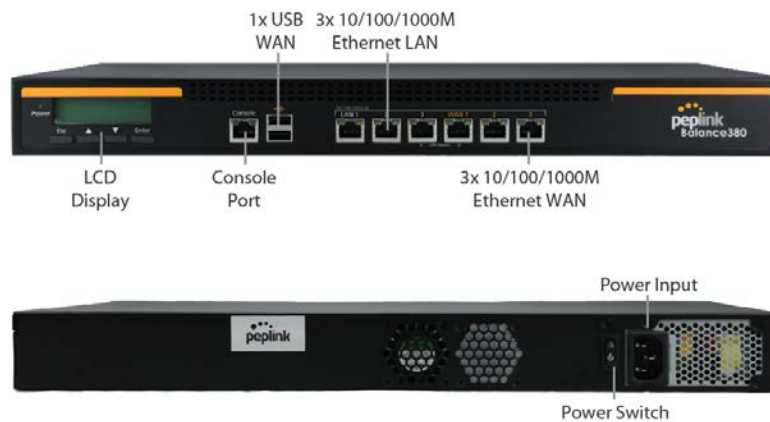

6.14.2 LED Indicators

The statuses indicated by the front panel LEDs are as follows:

Power and Status Indicators	
Power LED	OFF – Power off
	Green – Power on

LAN Port, WAN 1 – 3 Ports	
Right LED	Orange – 1000 Mbps
	Green – 100 Mbps
	OFF – 10 Mbps
Left LED	Solid – Port is connected without traffic
	Blinking – Data is transferring
	OFF – Port is not connected
Port Type	Auto MDI/MDI-X ports

Console and USB Ports	
Console Port	Reserved for engineering use
USB Ports	For connecting a 4G/3G USB modem

6.15 Peplink Balance 380X

6.15.1 Panel Appearance

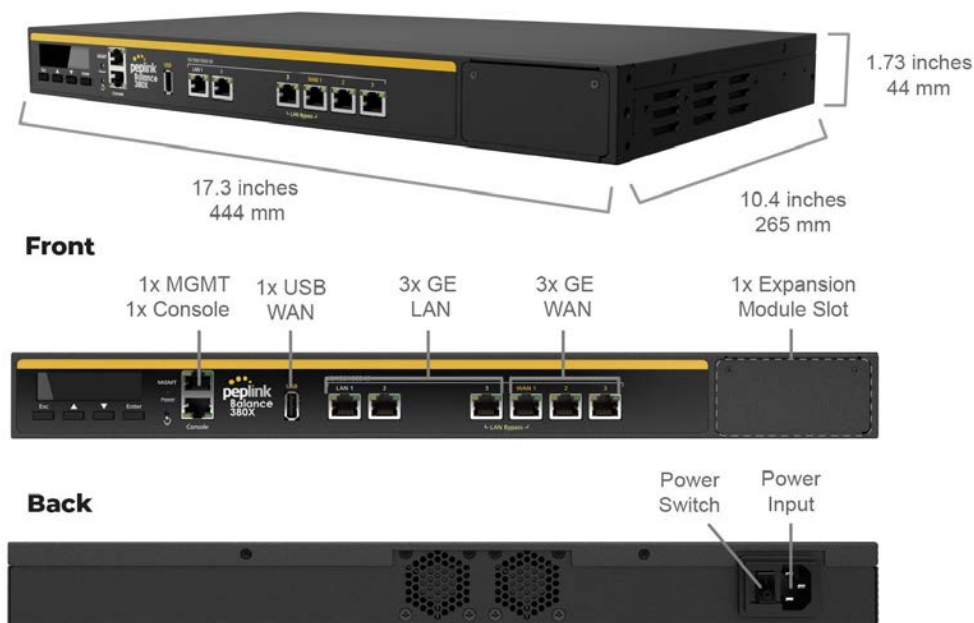

6.15.2 LED Indicators

The statuses indicated by the front panel LEDs are as follows:

Power and Status Indicators	
Power LED	OFF – Power off
	Green – Power on

LAN Port, WAN 1 – 3 Ports	
Right LED	Green – 1000 Mbps
	OFF – 10 / 100 Mbps
Left LED	Solid – Port is connected without traffic
	Blinking – Data is transferring
	OFF – Port is not connected
Port Type	Auto MDI/MDI-X ports

Console and USB Ports	
Console Port	Reserved for engineering use
USB Ports	For connecting a 4G/3G USB modem

6.15.3 Flex Module Mini



1x LTE-A Module	
Interface	1x Embedded LTE-A Cellular Modems with Redundant SIM Slots
Antenna Connectors	2x SMA Cellular Antenna Connectors
Downlink / Uplink Datarate	300Mbps/50Mbps (CAT-6) 600Mbps/150Mbps (CAT-12)
Power Consumption	10W
Weight	0.83 pounds 375 grams



1xLTE-A Module	
Interface	1x Embedded LTE-A Cellular Modems with Redundant SIM Slots
Antenna Connectors	4x SMA Cellular Antenna Connectors
Downlink / Uplink Datarate	1.2 Gbps/150 Mbps (CAT-18)
Power Consumption	10W
Weight	0.83 pounds 375 grams

6.16 Peplink Balance 580

6.16.1 Panel Appearance

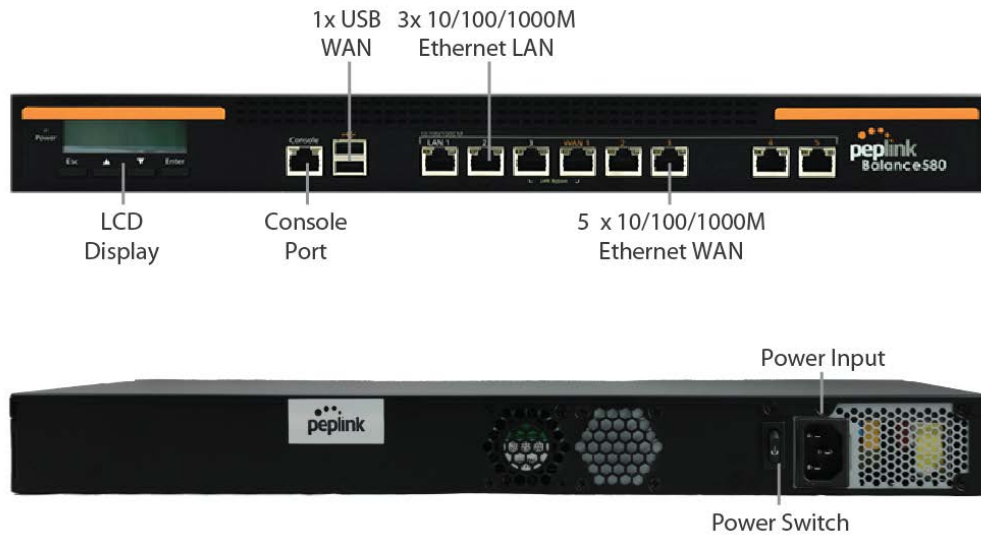

6.16.2 LED Indicators

The statuses indicated by the front panel LEDs are as follows:

Power and Status Indicators	
Power LED	OFF – Power off
	Green – Power on
LAN Port, WAN 1 – 5 Ports	
Right LED	Orange – 1000 Mbps
	Green – 100 Mbps
	OFF – 10 Mbps
Left LED	Solid – Port is connected without traffic
	Blinking – Data is transferring
	OFF – Port is not connected
Port Type	Auto MDI/MDI-X ports

Console and USB Ports	
Console Port	Reserved for engineering use
USB Ports	For connecting a 4G/3G USB modem

6.17 Peplink Balance 580X

6.17.1 Panel Appearance

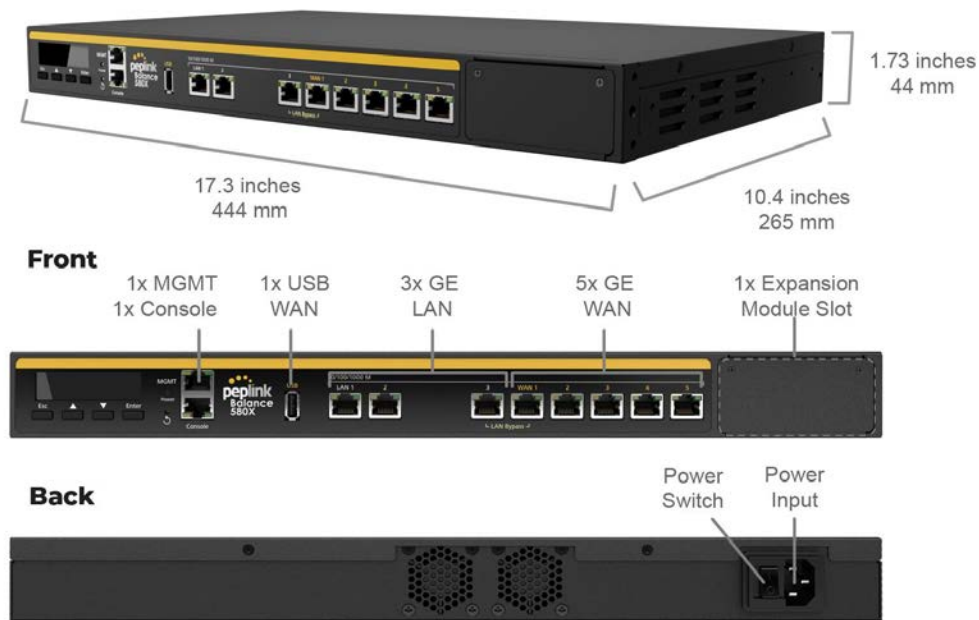

6.17.2 LED Indicators

The statuses indicated by the front panel LEDs are as follows:

Power and Status Indicators	
Power LED	OFF – Power off
	Green – Power on

LAN Port, WAN 1 – 5 Ports	
Right LED	Green – 1000 Mbps
	OFF – 10 / 100 Mbps
Left LED	Solid – Port is connected without traffic
	Blinking – Data is transferring
	OFF – Port is not connected
Port Type	Auto MDI/MDI-X ports

Console and USB Ports	
Console Port	Reserved for engineering use
USB Ports	For connecting a 4G/3G USB modem

6.17.3 Flex Module Mini



1x LTEA Module	
Interface	1x Embedded LTE-A Cellular Modems with Redundant SIM Slots
Antenna Connectors	2x SMA Cellular Antenna Connectors
Downlink / Uplink Datarate	300Mbps/50Mbps (CAT-6) 600Mbps/150Mbps (CAT-12)
Power Consumption	10W
Weight	0.83 pounds 375 grams



1xLTEA Module	
Interface	1x Embedded LTE-A Cellular Modems with Redundant SIM Slots
Antenna Connectors	4x SMA Cellular Antenna Connectors
Downlink / Uplink Datarate	1.2 Gbps/150 Mbps (CAT-18)
Power Consumption	10W
Weight	0.83 pounds 375 grams

6.18 Peplink Balance 710

6.18.1 Front Panel Appearance

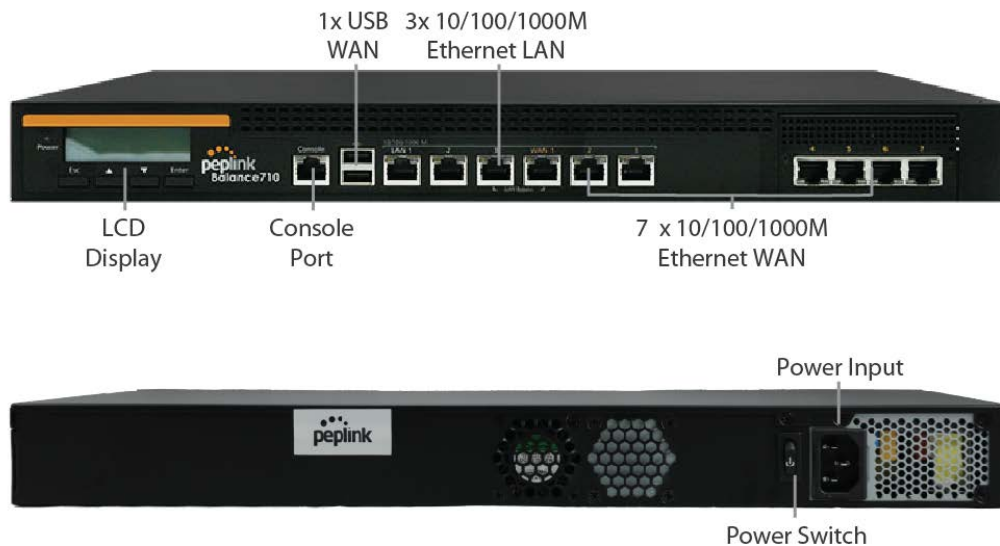

6.18.2 LED Indicators

Status indicated in the front panel is as follows:

LED Indicator	
Power LED	OFF – Power off
	Green – Power on

LAN Port, WAN 1 – 7 Ports	
Green LED	Orange – 1000 Mbps
	Green – 100 Mbps
	OFF – 10 Mbps
Orange LED	Solid – Port is connected without traffic
	Blinking – Data is transferring
	OFF – Port is not connected
Port Type	Auto MDI/MDI-X ports

Console & USB Ports	
Console Port	Reserved for engineering use
USB Ports	For connecting a 4G/3G USB modem

6.19 Peplink Balance 1350

6.19.1 Panel Appearance

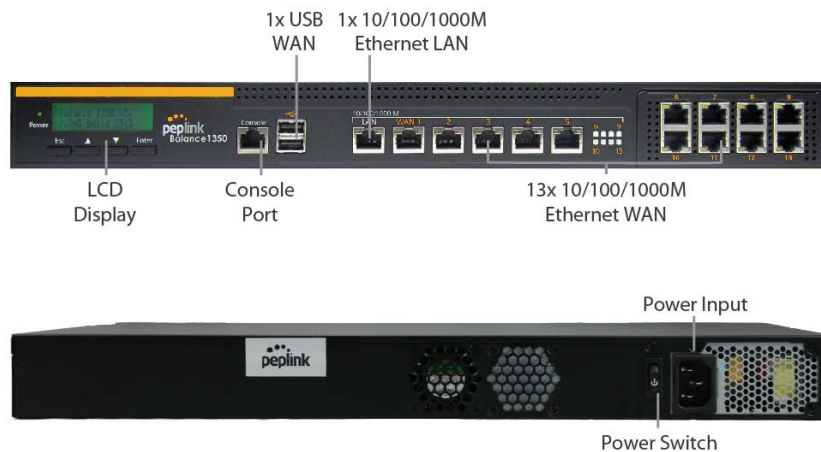

6.19.2 LED Indicators

Status indicated in the front panel is as follows:

LED Indicator	
Power LED	OFF – Power off
	Green – Power on

LAN Port, WAN 1 – 13 Ports	
Right LED	Orange – 1000 Mbps
	Green – 100 Mbps
	OFF – 10 Mbps
Left LED	Solid – Port is connected without traffic
	Blinking – Data is transferring
	OFF – Port is not connected
Port Type	Auto MDI/MDI-X ports

Console & USB Ports	
Console Port	Reserved for engineering use
USB Ports	For connecting a 4G/3G USB modem

6.20 Peplink Balance 2500

6.20.1 Panel Appearance

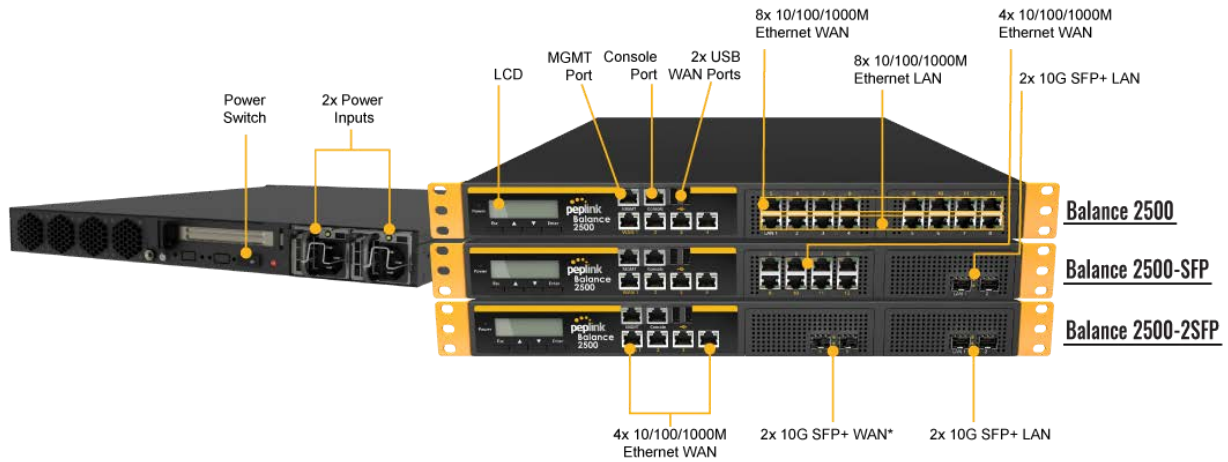

*Balance 2500 is available in two configurations with different LAN interfaces.

6.20.2 LED Indicators

Status indicated in the front panel is as follows:

LED Indicator	
Power LED	OFF – Power off
	Green – Power on

LAN and WAN Ports	
Right LED	Orange – 1000 Mbps
	Green – 100 Mbps
	OFF – 10 Mbps
Left LED	Solid – Port is connected without traffic
	Blinking – Data is transferring
	OFF – Port is not connected
Port Type	Auto MDI/MDI-X ports

Console & USB Ports	
Console Port	Reserved for engineering use
USB Ports	For connecting a 4G/3G USB modem

7 Peplink MediaFast Overview

7.1 Peplink MediaFast 200

7.1.1 Panel Appearance

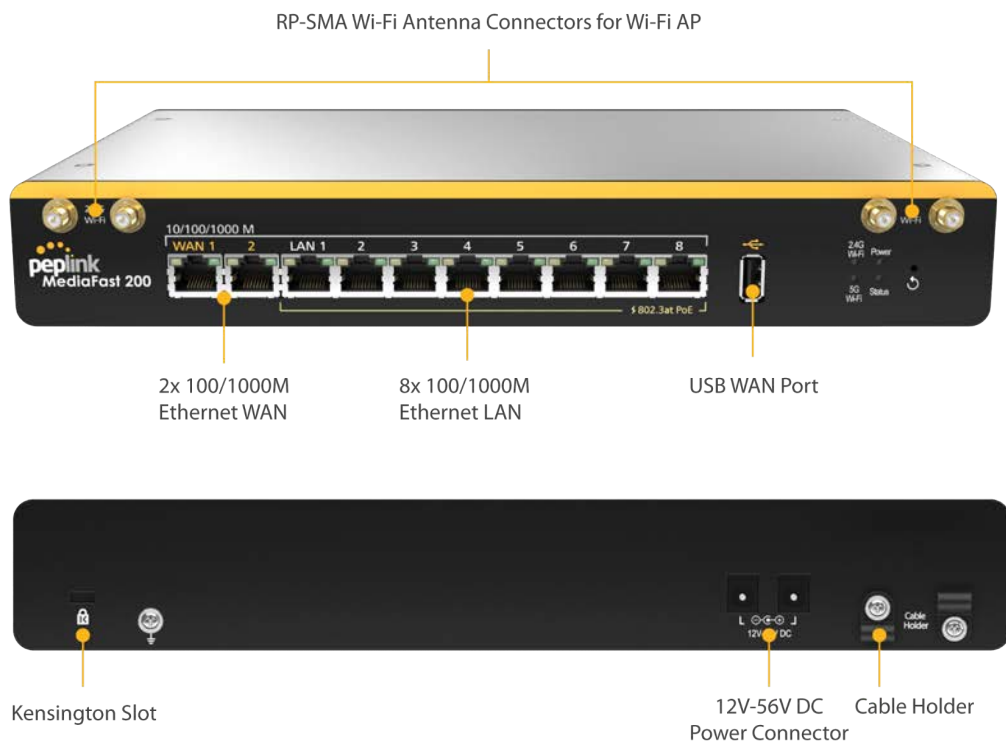

7.1.2 LED Indicators

Status indicated in the front panel is as follows:

LED Indicator	
Power LED	OFF – Power off
	Green – Power on

LAN 1-3 Ports, WAN 1-5 Ports	
Right LED	Orange – 1000 Mbps
	Green – 100 Mbps
	OFF – 10 Mbps
Left LED	Solid – Port is connected without traffic
	Blinking – Data is transferring
	OFF – Port is not connected
Port Type	Auto MDI/MDI-X ports

Console & USB Ports	
Console Port	Reserved for engineering use
USB Ports	For connecting 4G/3G USB modems

7.2 Peplink MediaFast 500

7.2.1 Panel Appearance



7.2.2 LED Indicators

Status indicated in the front panel is as follows:

LED Indicator	
Power LED	OFF – Power off
	Green – Power on

LAN 1-3 Ports, WAN 1-5 Ports	
Right LED	Orange – 1000 Mbps
	Green – 100 Mbps
	OFF – 10 Mbps
Left LED	Solid – Port is connected without traffic
	Blinking – Data is transferring
	OFF – Port is not connected
Port Type	Auto MDI/MDI-X ports

Console & USB Ports	
Console Port	Reserved for engineering use
USB Ports	For connecting 4G/3G USB modems

7.3 Peplink MediaFast 750

7.3.1 Panel Appearance

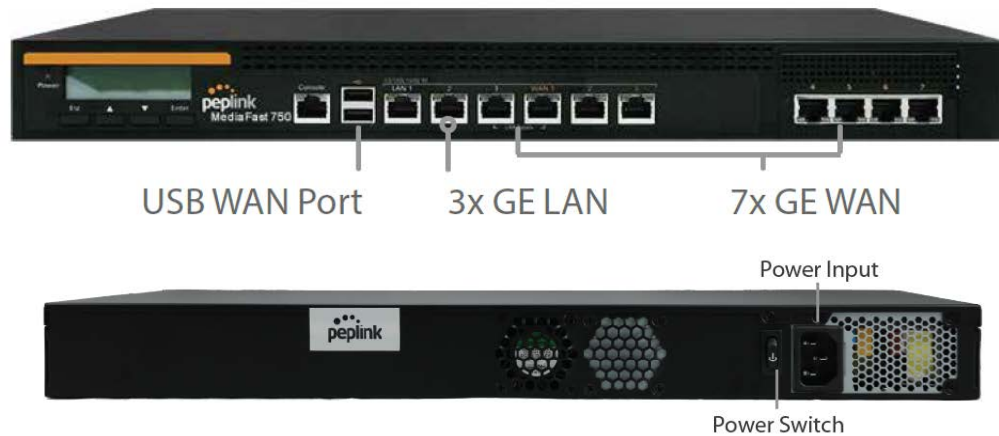

7.3.2 LED Indicators

Status indicated in the front panel is as follows:

LED Indicator	
Power LED	OFF – Power off
	Green – Power on

LAN 1-3 Ports, WAN 1-5 Ports	
Right LED	Orange – 1000 Mbps
	Green – 100 Mbps
	OFF – 10 Mbps
Left LED	Solid – Port is connected without traffic
	Blinking – Data is transferring
	OFF – Port is not connected
Port Type	Auto MDI/MDI-X ports

Console & USB Ports	
Console Port	Reserved for engineering use
USB Ports	For connecting 4G/3G USB modems

8 Peplink Flex-Module Supported Models

8.1 Peplink EPX

The EPX is a rapidly deployable, powerful, and versatile SD-WAN router that connects a wide range of WAN options from LTE-A, satellite modems, to fixed line networks this can be used simultaneously to allow bonding using our SpeedFusion technology. With its modular construction, the EPX is suitable for any deployment.

8.1.1 Main Chassis

EPX Main Chassis	
Power Input	AC Input 100V - 240V
Power Consumption (Main Chassis only)	215W
Throughput	30Gbps
PepVPN/SpeedFusion Throughput (256-bit AES)	2Gbps
Dimensions	18.9 x 21.7 x 3.6 inches - 480 x 550 x 90 mm
Weight (No Modules)	31.3 pounds - 14.2 kilograms
Operating Temperature	32° – 113°F (0° – 45°C)
Humidity	5% – 90% (non-condensing)
Certifications	FCC, IC, CE-RED EN 50155: Railway Applications EN 61373:1999 IEC 61373:1999 : Shock and Vibration Resistance EN 50121: Rolling Stock EMC, Signalling and Telecom Apparatus
Warranty	1-Year Limited Warranty

8.1.2 Panel Appearance

Front

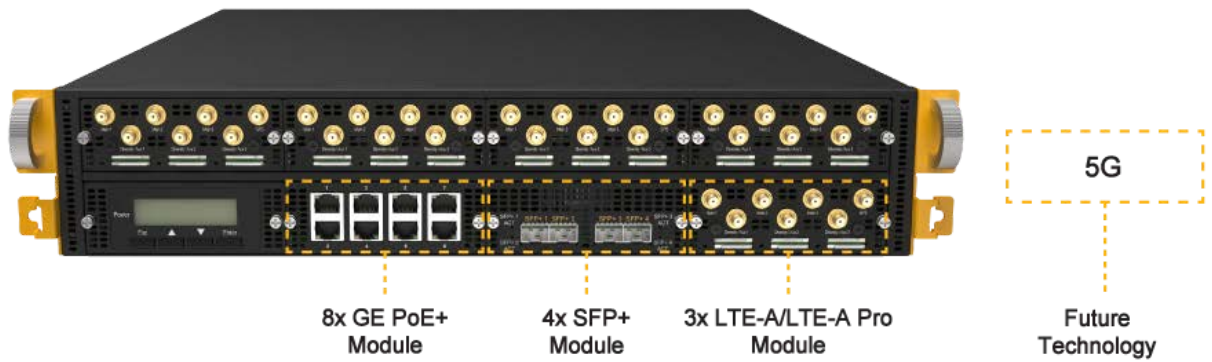

Back



8.1.3 LED Indicators

Status indicated in the LAN/WAN port module is as follows:

Note: some EPX configurations are not shipped with this module

LED Indicator	
Power LED	OFF – Power off
	Green – Power on

LAN Port, WAN Ports	
Right LED	Orange – Enabled as WAN port
	Green – PoE enabled
	OFF – PoE is disabled
Left LED	Solid – Port is connected without traffic
	Blinking – Data is transferring
	OFF – Port is not connected
Port Type	Auto MDI/MDI-X ports

Console & USB Ports	
Console Port	CLI Console connection
USB Ports	For connecting a 4G/3G USB modem

8.2 Peplink SDX

The SDX is a Modular Enterprise Grade Router. In addition to popular features such as SpeedFusion SD-WAN and InControl centralized management, the SDX has an expandable module that you can change according to your needs.

The SDX includes two integrated SFP+ WAN Ports, as well as eight PoE-enabled LAN Ports. These ports are available no matter which module you use.

8.2.1 Main Chassis

SDX Main Chassis	
Power Input	AC Input 100V - 240V
Power Consumption	80W System* , 330W PoE+ Power Budget
Throughput	12 Gbps
PepVPN/SpeedFusion Throughput	No Encryption: 1 Gbps 256-bit AES: 600 Mbps
Dimensions	17.2 x 13.3 x 1.7 inches - 438 x 340 x 44 mm
Weight (No Modules)	11.7 pounds - 5.3 kilograms
Operating Temperature	32° – 104°F (0° – 40°C)
Humidity	5% – 90% (non-condensing)
Certifications	FCC, IC, CE

* 80W consumption for the main chassis, 20W consumption for the optional module.

8.2.2 Panel Appearance

Front:

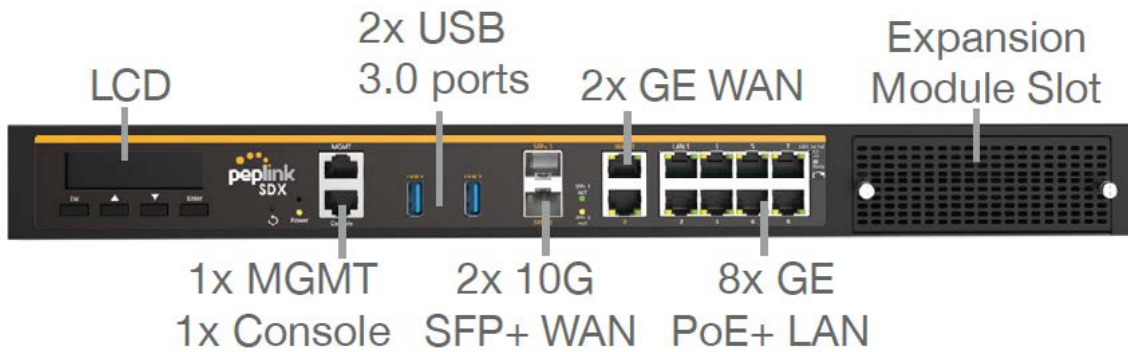

BPL-SDX

Back:



8.2.3 LED Indicators

LED Indicator	
Power LED	OFF – Power off
	Green – Power on

WAN Ports	
Right LED	Green – 1000 Mbps
	OFF – 10 Mbps / 100 Mbps or the port is not connected
Left LED	Solid – Port is connected without traffic
	Blinking – Data is transferring
	OFF – Port is not connected
Port Type	Auto MDI/MDI-X ports

LAN Ports	
Right LED	Green – PoE enabled
	OFF – PoE is disabled
Left LED	Solid – Port is connected without traffic
	Blinking – Data is transferring
	OFF – Port is not connected
Port Type	Auto MDI/MDI-X ports

Console, MGMT & USB Ports	
Console Port	CLI console connection
USB Ports	For connecting 4G/3G USB modems for additional WAN connections
MGMT Port	Management port

8.3 Peplink SDX Pro

In addition to the power of the SDX, the SDX Pro offers greater flexibility and functionality. It has two FlexModule slots, enabling you to customize the device with different modules to suit any deployment. It supports edge computing so it can deliver websites, applications, and docker containers to connected devices.

8.3.1 Main Chassis

SDX Pro Main Chassis	
Power Input	AC Input 100V - 240V
Power Consumption	140W System* , 420W PoE+ Power Budget
Throughput	24 Gbps
PepVPN/SpeedFusion Throughput	No Encryption: 1 Gbps 256-bit AES: 600 Mbps
Dimensions	17.2 x 13.8 x 1.7 inches - 438 x 350 x 44 mm
Weight (No Modules)	15.9 pounds - 7.2 kilograms
Operating Temperature	32° – 104°F (0° – 40°C)
Humidity	10% – 85% (non-condensing)
Certifications	FCC, IC, CE

* 140W consumption for the main chassis, 20W consumption for the optional module.

8.3.2 Panel Appearance



* WAN ports are configured as a LAN ports by default, configuration is changeable on the Web Admin

8.3.3 LED Indicators

LED Indicator	
Power LED	OFF – Power off
	Green – Power on

WAN Ports	
Right LED	Green – 1000 Mbps
	OFF – 10 Mbps / 100 Mbps or port is not connected
Left LED	Solid – Port is connected without traffic
	Blinking – Data is transferring
	OFF – Port is not connected
Port Type	Auto MDI/MDI-X ports

Console, MGMT & USB Ports	
Console Port	CLI console connection
USB Ports	For connecting 4G/3G USB modems for additional WAN connections
MGMT Port	Management port

8.4 Flex Module Expansion Modules

8.4.1 8x GE PoE+ Module (EXM-8C)

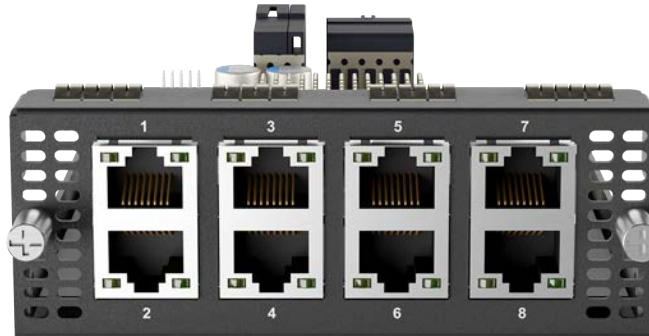

8x GE PoE Module	
Interface	8x 10/100/1000M Ethernet Ports * Capable of PoE+
Power Consumption	15W (255W max. with 802.3at/af PoE+ Output)
Dimensions	4.1 x 7.4 x 1.5 inches 103 x 188 x 38 mm
Weight	1.1 pounds (475 grams)

* Module can be configured with LAN or WAN ports as needed.

LED Indicator:

Ethernet Ports	
Right LED	Orange – Enabled as WAN port
	Green – PoE enabled
	OFF – PoE is disabled
Left LED	Solid – Port is connected without traffic
	Blinking – Data is transferring
	OFF – Port is not connected
Port Type	Auto MDI/MDI-X ports

8.4.2 4x SFP+ Module (EXM-4F)



4x SFP+ Module	
Interface	4x SFP+ Ports *
Power Consumption	11W
Dimensions	4.1 x 7.4 x 1.5 inches 103 x 188 x 38 mm
Weight	0.83 pounds (375 grams)

8.4.3 3x LTE-A Module (EXM-3LTEA)



3x LTE-A Module	
Interface	3x Embedded LTE-A Cellular Modems with Redundant SIM Slots
Antenna Connectors	6x SMA Cellular Antenna Connectors 1x SMA GPS Antenna Connector
Power Consumption	20W
Dimensions	4.1 x 7.4 x 1.5 inches 103 x 188 x 38 mm
Weight	0.83 pounds (375 grams)

8.4.4 4x LTE-A Module (EXM-4LTEA)



3x LTE-A Module	
Interface	4x Embedded LTE-A Cellular Modems with Redundant SIM Slots
Antenna Connectors	8x SMA Cellular Antenna Connectors 1x SMA GPS Antenna Connector
Power Consumption	20W
Dimensions	4.1 x 7.4 x 1.5 inches 103 x 188 x 38 mm
Weight	0.83 pounds (375 grams)

8.4.5 CAT-18. 2x LTE-A Module (EXM-2GLTE-G)



2x LTE-A Module	
Interface	2x Embedded LTE-A Cellular Modems with Redundant 4FF Nano SIM Slots
Antenna Connectors	8x SMA Cellular Antenna Connectors 1x SMA GPS Antenna Connector
Power Consumption	20W
Dimensions	4.1 x 7.4 x 1.5 inches 103 x 188 x 38 mm
Weight	0.83 pounds (375 grams)

8.4.6 SIM Injector FlexModule (EXM-SIM-BK56)

* Compatible with EPX, SDX Pro



SIM Injector FlexModule	
SIM Slot Capacity	56 4FF Nano SIM Cards
Power Consumption	15W
Dimensions	4.1 x 7.4 x 1.5 inches 103 x 188 x 38 mm
Weight	1.30 pounds (600 grams)

8.4.7 2x 5G Module (EXM-2X5GD)



2x 5G Module	
Interface	2x Embedded Cellular Modems with Redundant 4FF Nano SIM Slots
Antenna Connectors	8x SMA Cellular Antenna Connectors 1x SMA GPS Antenna Connector
Power Consumption	20W
Dimensions	4.1 x 7.4 x 1.5 inches 103 x 188 x 38 mm
Weight	0.83 pounds (375 grams)

9 OLED Display Menu

- > HA State: Master/Slave
 - > LAN IP
 - > VIP
- > System Status
 - > System
 - > Firmware ver. (shows firmware version)
 - > Serial number (shows serial number)
 - > System time (shows current time)
 - > System uptime (shows system uptime since last reboot)
 - > CPU load (shows current CPU loading, 0-100%)
 - > LAN
 - > Status (shows LAN port physical status)
 - > IP address (shows LAN IP address)
 - > Subnet mask (shows LAN subnet mask)
 - > Link status
 - > WAN1
 - > WAN2
 - > WAN3*
 - > VPN status (shows Connected/Disconnected)
 - >VPN Profile 1
 - >VPN Profile 2
 - >...
 - >VPN Profile n
 - > Link usage
 - > Throughput in (shows transfer rate in Kbps)
 - > WAN1
 - > WAN2
 - > WAN3*
 - > Throughput out (shows transfer rate in Kbps)
 - > WAN1
 - > WAN2
 - > WAN3*
 - > Data Transferred (shows volume transferred since last reboot in MB)
 - > WAN1
 - > WAN2
 - > WAN3*
- > Maintenance
 - > Reboot > Reboot? (Yes/No) (to reboot the unit)
 - > Factory default > Factory default? (Yes/No) (to restore factory defaults)
- > LAN config
 - > Port speed (shows port speed: Auto, 10baseT-FD, 10baseT-HD, 100baseTx-FD, 100baseTx-HD, 1000baseTx-FD)
 - > LAN
 - > WAN1
 - > WAN2
 - > WAN3*



*Layout continues as such for all available WAN ports

10 Installation

The following section details connecting the Peplink Balance to your network:

10.1 Preparation

Before installing your Peplink Balance, please prepare the following:

- At least one Internet/WAN access account
- For each network connection, one 10/100BaseT UTP cable with RJ45 connector, one 1000BaseT Cat5E UTP cable for the Gigabit port, or one USB modem for the USB WAN port
- A computer with the TCP/IP network protocol and a web browser installed— Supported browsers include Microsoft Internet Explorer 11 or above, Mozilla Firefox 24 or above, Apple Safari 7 or above, and Google Chrome 18 or above.

10.2 Constructing the Network

At the high level, construct the network according to the following steps:

1. With an Ethernet cable, connect a computer to one of the LAN ports on the Peplink Balance. For Peplink Balance models that support multiple connections, repeat with different cables connect up to 4 computers.
2. With another Ethernet cable, connect the WAN/broadband modem to one of the WAN ports on the Peplink Balance. Repeat using different cables to connect from two to 13 WAN/broadband connections or connect a USB modem to the USB WAN port.
3. Connect the provided power adapter or cord to the power connector on the Peplink Balance, and then plug the power adapter into a power outlet.

11 Basic Configuration

11.1 Connecting to the Web Admin Interface

Start a web browser on a computer that is connected with the Peplink Balance through the LAN.

To connect to the web admin of the Peplink Balance, enter the following LAN IP address in the address field of the web browser:

`https://192.168.1.1`

(This is the default LAN IP address of the Peplink Balance.) Enter the following to access the web admin interface.

Username: admin

Password: admin

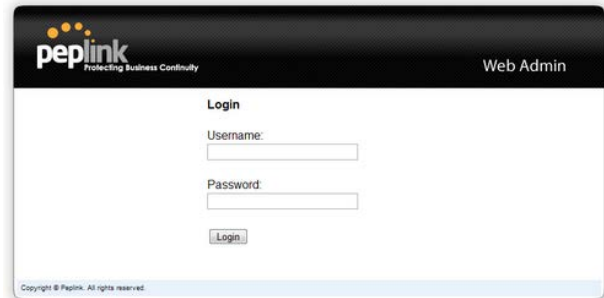

(This is the default admin user login of the Peplink Balance.)

You must change the default password on the first successful login.

Password requirements are: A minimum of 10 lower AND upper case characters, including at least 1 number.

When HTTP is selected, the URL will be redirected to HTTPS by default.

After successful login, the **Dashboard** of the web admin interface will be displayed.

Important Note

The **Save** button causes the changes to be saved. Configuration changes (e.g., WAN, LAN, admin settings, etc.) take effect after clicking the **Apply Changes** button on each page's top-right corner.

11.2 Configuration with the Setup Wizard

The Setup Wizard simplifies the task of configuring WAN connection(s) by guiding the configuration process step-by-step.

To begin, click **Setup Wizard** after connecting to the web admin interface.



Click **Next >>** to begin.

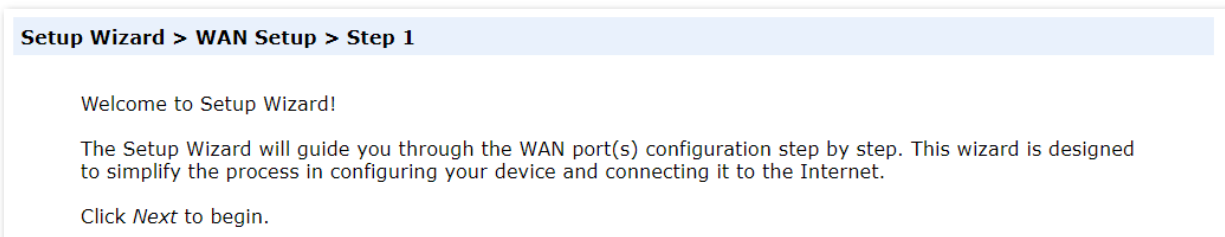

Select **Yes** if you want to set up drop-in mode using the Setup Wizard.

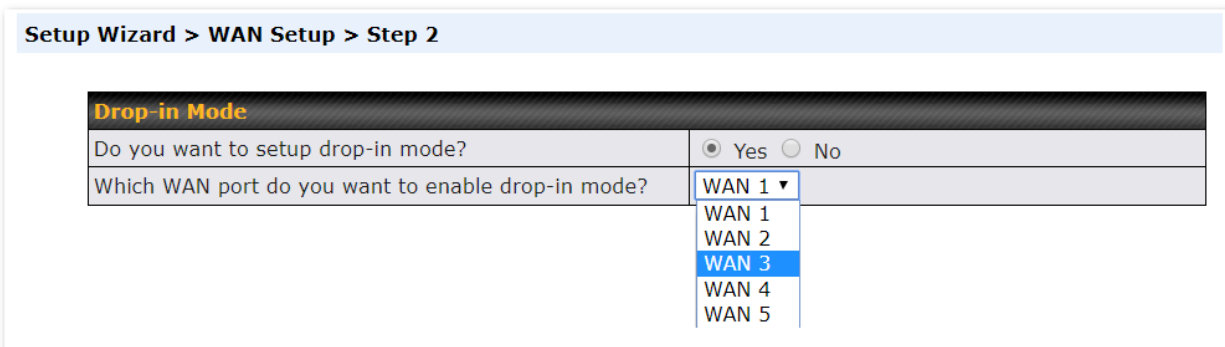

Click on the appropriate checkbox(es) to select the WAN connection(s) to be configured. If you have chosen to configure drop-in mode using the Setup Wizard, the WAN port to be configured in drop-in mode will be checked by default.

Setup Wizard > WAN Setup > Step 3

Choose the WAN port(s) to be configured.

WAN Ports ?	
WAN 1	<input type="checkbox"/>
WAN 2 (Drop-in)	<input checked="" type="checkbox"/>
WAN 3	<input type="checkbox"/>
WAN 4	<input type="checkbox"/>
WAN 5	<input type="checkbox"/>
Mobile Internet	<input type="checkbox"/>

If drop-in mode is going to be configured, the setup wizard will move on to **Drop-in Settings**.

Setup Wizard > WAN Setup > Step 4

Enter the parameters of Drop-in Settings for WAN 2.

Drop-in Settings	
IP Address	<input type="text"/>
Subnet Mask	255.255.255.0 (/24) ▼
Default Gateway	<input type="text"/>
DNS Servers	DNS server 1: <input type="text"/> DNS server 2: <input type="text"/>
Upload Bandwidth	1000 <input type="text"/> Mbps ▼
Download Bandwidth	1000 <input type="text"/> Mbps ▼

If you are not using drop-in mode, select the connection method for the WAN connection(s) from the following screen:

Setup Wizard > WAN Setup > Step 4

Choose a connection method for WAN 2.

Connection Method ?	
Method	Select
Static IP	<input type="radio"/>
DHCP	<input checked="" type="radio"/>
PPPoE	<input type="radio"/>
Disable	<input type="radio"/>

Depending on the selection of connection type, further configuration may be needed. For example, PPPoE and static IP require additional settings for the selected WAN port. Please refer to **Section 13, Configuring the WAN Interface(s)** for details on setting up DHCP, static IP, and PPPoE.

If **Mobile Internet Connection** is checked, the setup wizard will move on to **Operator Settings**.

Setup Wizard > WAN Setup > Step 4

Select whether Operator Settings for Mobile Internet will be automatically detected or customized.

Operator Settings (for HSPA/EDGE/GPRS only) ?	
Settings	Select
Auto	<input type="radio"/>
Custom	<input checked="" type="radio"/>

If **Custom Mobile Operator Settings** is selected, APN parameters are required. Some service providers may charge a fee for connecting to a different APN. Please consult your service provider for the correct settings.

Setup Wizard > WAN Setup > Step 5

Enter the parameters of Mobile Operator Settings for Mobile Internet.

Mobile Operator Settings ?	
APN	<input type="text"/>
Login ID	<input type="text"/>
Password	<input type="text"/>
Dial Number	<input type="text"/>

Click on the appropriate check box(es) to select the preferred WAN connection(s). Connection(s) not selected in this step will be used as a backup only. Click **Next >>** to continue.

Setup Wizard > WAN Setup > Step 8

Choose the preferred WAN Port(s) that is to be used as primary connection. The port(s) not selected in this step will only be used when none of the connection of the preferred port is up.

Preferred WAN Port Selection ?	
Port	Preferred
WAN 1	<input checked="" type="checkbox"/>
WAN 2	<input checked="" type="checkbox"/>

Choose the time zone of your country/region. Check the box **Show all** to display all time zone options.

Setup Wizard > WAN Setup > Step 9

Choose time zone of your Country / Region.

Time Zone Settings	
Time Zone	(GMT) Greenwich Mean Time : Dublin, Edinburgh, Lisbon, Lo ▾ (GMT) Greenwich Mean Time : Dublin, Edinburgh, Lisbon, London (GMT+01:00) West Central Africa

Check in the following screen to make sure all settings have been configured correctly, and then click **“Save Settings”** to confirm.

Setup Wizard > WAN Setup > Final Step

Confirm the WAN connection(s) configuration below. Click *Back* to modify the configuration settings in previous steps. Click *Save Settings* when you are done.

Summary of WAN Port(s) Configuration ?	
WAN 1	
Connection Method	DHCP
Upload Bandwidth	1000 Mbps
Download Bandwidth	1000 Mbps
Preferred WAN Port(s)	
Ports	WAN 1 WAN 2
Time Zone Settings	
Time Zone	(GMT) Greenwich Mean Time : Dublin, Edinburgh, Lisbon, London

After finishing the last step in the setup wizard, click **Apply Changes** on the page header to allow the configuration changes to take effect.

12 SpeedFusion Cloud

With Peplink products, your device is able to connect to SpeedFusion Cloud without the use of a second endpoint. This service has wide access to a number of SpeedFusion endpoints hosted from around the world, providing your device with unbreakable connectivity wherever you are.*



*SpeedFusion Cloud is supported in firmware version 8.1.0 and above. SpeedFusion Cloud is a subscription basis. SpeedFusion Cloud license can be purchased at <https://store.peplink.com/> > **Cloud Solutions** > **SpeedFusion Cloud Service**.

12.1 Activate SpeedFusion Cloud Service

You are entitled to a 30-day free period with 100GB of SpeedFusion usage upon activation of the SpeedFusion Cloud service. This offer is limited to once per device. To get your activation key please visit SpeedFusion Cloud.

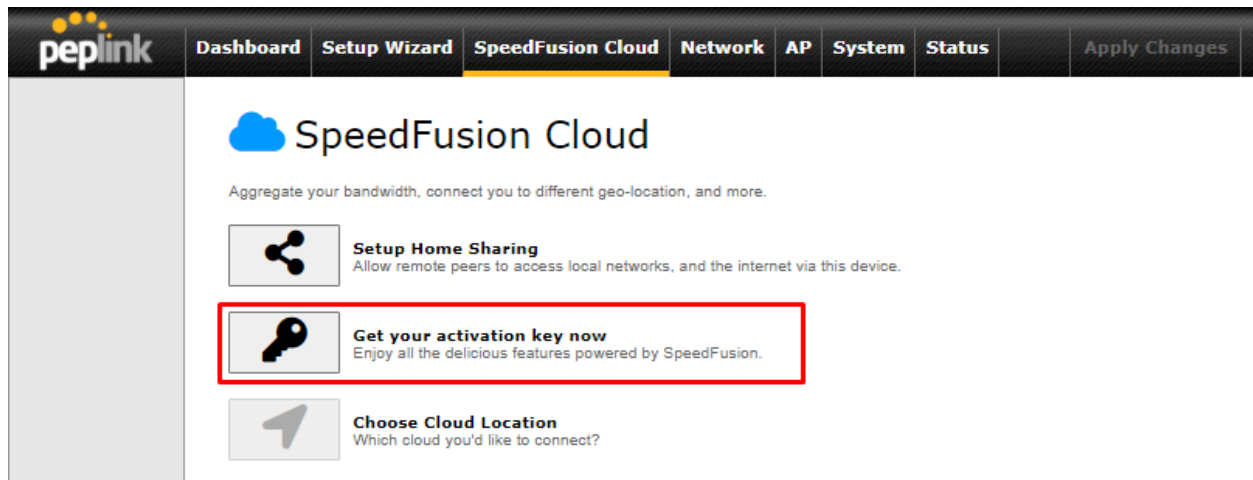

Go to activate.speedfusion.com and select the type of SpeedFusion Cloud service, “Via Free 30-days Trial” or “Via Care Plans”, that you would like to activate. Next, register or login to your account.

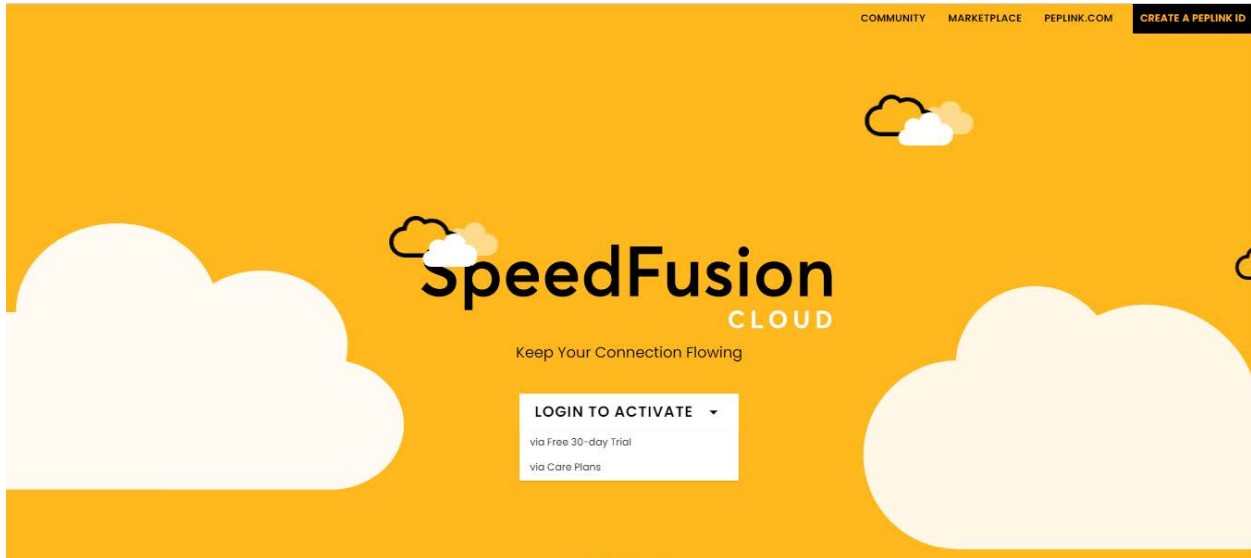

Select the devices that you wish to activate SpeedFusion Cloud on and click **ACTIVATE**.

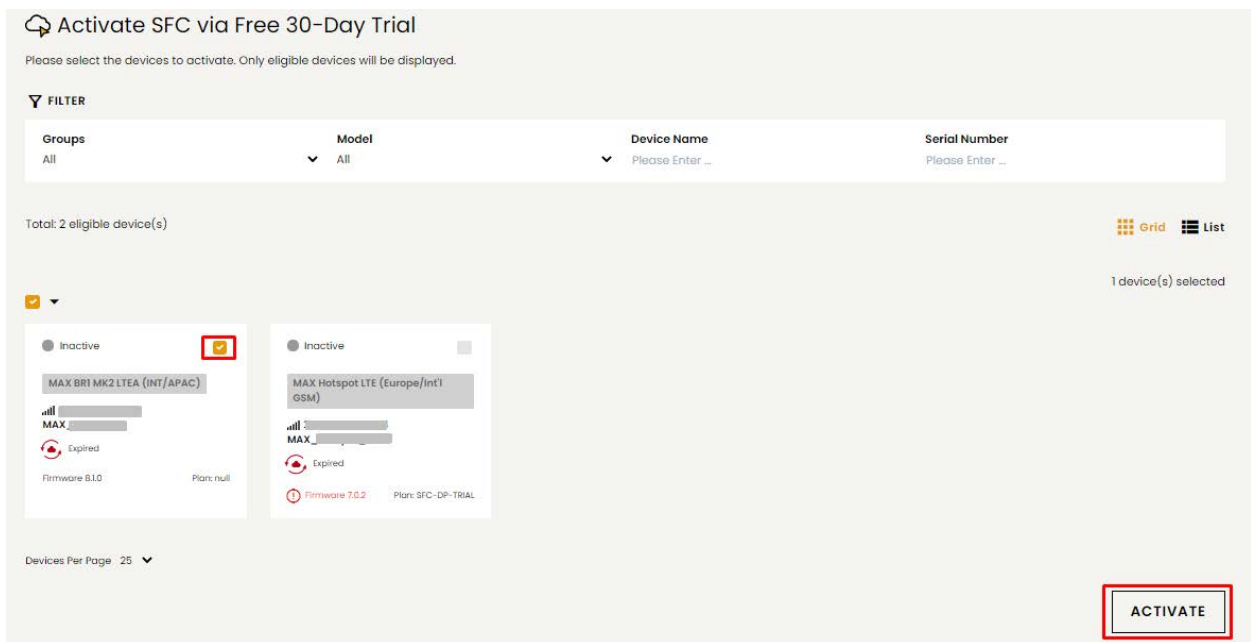

From **System > Features Add-ons**, paste the license key into the window and click on **Activate** once you have received the license key.

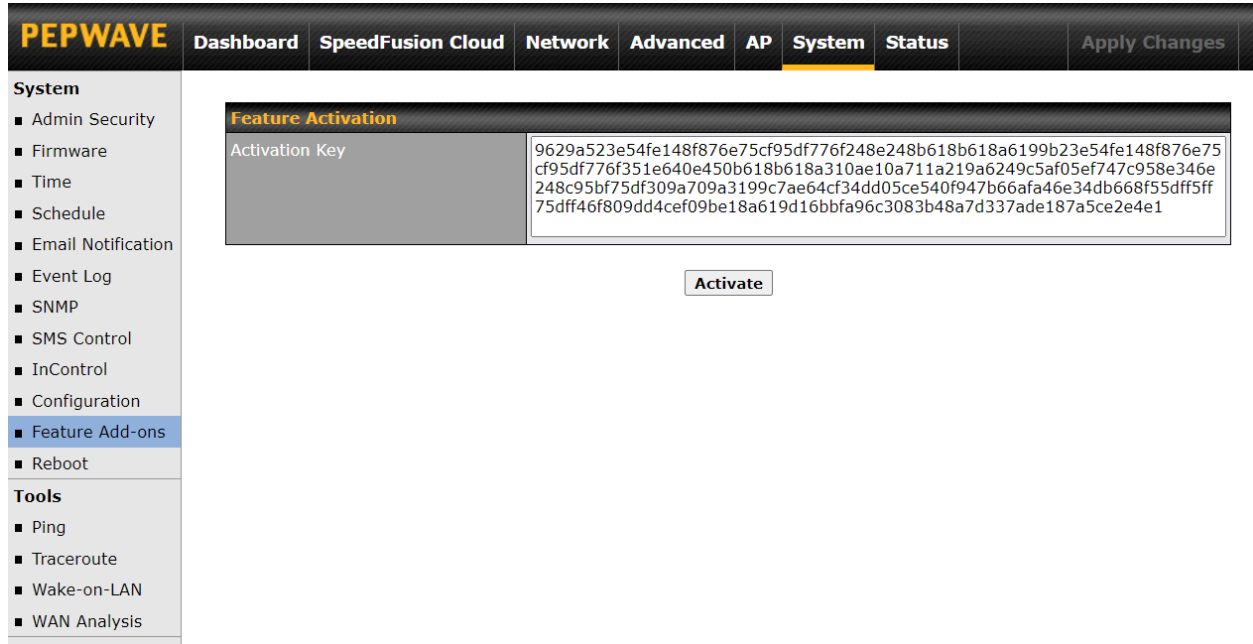

PEPWAVE Dashboard SpeedFusion Cloud Network Advanced AP **System** Status Apply Changes

System

- Admin Security
- Firmware
- Time
- Schedule
- Email Notification
- Event Log
- SNMP
- SMS Control
- InControl
- Configuration
- **Feature Add-ons**
- Reboot

Tools

- Ping
- Traceroute
- Wake-on-LAN
- WAN Analysis

Feature Activation

Activation Key

```
9629a523e54fe148f876e75cf95df776f248e248b618b618a6199b23e54fe148f876e75cf95df776f351e640e450b618b618a310ae10a711a219a6249c5af05ef747c958e346e248c95bf75df309a709a3199c7ae64cf34dd05ce540f947b66afa46e34db668f55dff5ff75dff46f809dd4cef09be18a619d16bbfa96c3083b48a7d337ade187a5ce2e4e1
```

Activate

12.2 Enable SpeedFusion Cloud

Access the Web Admin of the device you want to create as the SFC Relay Server, navigating to the “SpeedFusion Cloud” tab.

To setup a SpeedFusion Cloud Relay Server, select "**Setup Home Sharing**" > Choose the **Cloud Location** you wish to connect to > Click on the **green tick button** to confirm the change.

SpeedFusion Cloud	Cloud Location
	Singapore (SIN) / 10ms <input checked="" type="checkbox"/>

The Home Sharing Code will be generated and other peers can use this code to establish a SpeedFusion Cloud connection that will forward the traffic to this device, allowing them to access local networks and the Internet via your WAN connection.

PEPWAVE Dashboard **SpeedFusion Cloud** Network Advanced AP System Status Apply Changes

SpeedFusion Cloud > Setup Home Sharing

Allow remote peers to access local networks, and the internet via this device.

SpeedFusion Cloud	Cloud Location
SFH-SHARE-SIN	Home Sharing Code: [REDACTED]-[REDACTED]-[REDACTED]-[REDACTED] COPY

To connect to SpeedFusion Cloud, you can select a Cloud Location of your choice, or simply **Automatic**, then the device will establish a connection to the nearest cloud server.

peplink Dashboard Setup Wizard **SpeedFusion Cloud** Network AP System Status Apply Changes

SpeedFusion Cloud > Choose Cloud Location

You can connect up to 3 different cloud locations.

SpeedFusion Cloud	Cloud Location
SDWC_SFC-HKG	Hong Kong (HKG)

Choose **Automatic** > Click on the green tick button to confirm the change.

peplink Dashboard Setup Wizard **SpeedFusion Cloud** Network AP System Status Apply Changes

SpeedFusion Cloud > Choose Cloud Location

You can connect up to 3 different cloud locations.

SpeedFusion Cloud	Cloud Location
	[Automatic]

Or you may select **Home Sharing** and use your **Home Sharing Code** to create a profile if you have set up a SpeedFusion Cloud Relay Client on another device.

SpeedFusion Cloud > Choose Cloud Location

You can connect up to 3 different cloud locations.

SpeedFusion Cloud	Cloud Location
	[Home Sharing] e.g. 1234-5678-1234-5678

Click on **Apply Changes** to save the change.

PEPWAVE Dashboard SpeedFusion Cloud Network Advanced AP System Status Apply Changes

Saved! Changes will be effective after clicking the 'Apply Changes' button.

SpeedFusion Cloud > Choose Cloud Location

You can connect up to 3 different cloud locations.

SpeedFusion Cloud	Cloud Location
SEC	--- Automatic ---

PEPWAVE Dashboard SpeedFusion Cloud Network Advanced AP System Status Apply Changes

Changes applied successfully.

SpeedFusion Cloud > Choose Cloud Location

You can connect up to 3 different cloud locations.

SpeedFusion Cloud	Cloud Location
SEC	--- Automatic ---

By default, the router will build a SpeedFusion tunnel to the SpeedFusion Cloud

PEPWAVE Dashboard SpeedFusion Cloud Network Advanced AP System Status [Apply Changes](#)

WAN Connection Status ?

Priority 1 (Highest)
Drag desired (Priority 1) connections here

Priority 2

1 Cellular 1	Connected to MY MAXIS LTE-A	Details
2 Cellular 2	Connected to MY MAXIS LTE-A	Details

Priority 3
Drag desired (Priority 3) connections here

Disabled

1 WAN 1	<input type="checkbox"/> Disabled	Details
2 WAN 2	<input type="checkbox"/> Disabled	Details
3 Cellular 3	<input type="checkbox"/> Disabled	Details
4 Cellular 4	<input type="checkbox"/> Disabled	Details
Wi-Fi WAN	<input type="checkbox"/> Disabled	Details
3 LAN 1 as WAN	<input type="checkbox"/> Disabled	Details
4 LAN 2 as WAN	<input type="checkbox"/> Disabled	Details
5 LAN 3 as WAN	<input type="checkbox"/> Disabled	Details

LAN Interface

Router IP Address: 192.168.50.1

Wi-Fi AP ON [Details](#)

PEPWAVE_EBB4

SpeedFusion Cloud

SFC	Established
Data usage allowance: 98.40 GB (Expiry date: Sep 01, 2020)	

If you are running a latency sensitive service like video streaming or VOIP, a WAN Smoothing sub-tunnel can be created. Navigate to **Speedfusion Cloud > Choose a cloud location > SFC**.

PEPWAVE Dashboard **SpeedFusion Cloud** Network Advanced AP System Status Apply Changes

SpeedFusion Cloud > Choose Cloud Location

You can connect up to 3 different cloud locations.

SpeedFusion Cloud	Cloud Location
SFC	--- Automatic --- ✖

A Speedfusion tunnel configuration window will pop out. Click on the + sign to create the WAN Smoothing sub-tunnel.

PEPWAVE Dashboard **SpeedFusion Cloud** Network Advanced AP System Status Apply Changes

SpeedFusion Cloud Profile

Enable

Cloud Location --- Automatic ---

1 - Default +

Tunnel Options

Local / Remote Tunnel ID 1 (default tunnel)

Tunnel Name Default

Data Port Auto Custom

Bandwidth Limit

WAN Smoothing

Overall Redundancy Level Off

Maximum Level on the Same Link Off

Forward Error Correction Off

Receive Buffer 0 ms

PEPWAVE Dashboard **SpeedFusion Cloud** Network Advanced AP System Status Apply Changes

SpeedFusion Cloud Profile

Enable

Cloud Location --- Automatic ---

1 - Default 2 - WAN Smoo... +

Tunnel Options

Local / Remote Tunnel ID 2

Tunnel Name WAN Smoothing

Data Port Auto Custom

Bandwidth Limit

WAN Smoothing

Overall Redundancy Level Normal

Maximum Level on the Same Link Normal

Forward Error Correction Off

Receive Buffer 0 ms

Click on **Save** and **Apply Changes** to save the configuration. Now, the router has 2 Speedfusion tunnels to the Speedfusion Cloud.

PEPWAVE | Dashboard | **SpeedFusion Cloud** | Network | Advanced | AP | System | Status | Apply Changes

WAN Connection Status ?

Priority 1 (Highest)
Drag desired (Priority 1) connections here

Priority 2

	Cellular 1	Connected to MY MAXIS LTE-A	Details
	Cellular 2	Connected to MY MAXIS LTE-A	Details

Priority 3
Drag desired (Priority 3) connections here

Disabled

	WAN 1	<input type="checkbox"/> Disabled	Details
	WAN 2	<input type="checkbox"/> Disabled	Details
	Cellular 3	<input type="checkbox"/> Disabled	Details
	Cellular 4	<input type="checkbox"/> Disabled	Details
	Wi-Fi WAN	<input type="checkbox"/> Disabled	Details
	LAN 1 as WAN	<input type="checkbox"/> Disabled	Details
	LAN 2 as WAN	<input type="checkbox"/> Disabled	Details
	LAN 3 as WAN	<input type="checkbox"/> Disabled	Details

LAN Interface

Router IP Address: 192.168.50.1

Wi-Fi AP ON [Details](#)

PEPWAVE_EBB4

SpeedFusion Cloud

SFC (1 - Default)	Established
SFC (2 - WAN Smoothing)	Established

Data usage allowance: 98.40 GB (Expiry date: Sep 01, 2020)

Create an outbound policy to steer the internet traffic to go into Speedfusion Cloud. Please go to **Advanced > Outbound Policy**, click on **Add Rule** to create a new outbound policy.

The screenshot shows the PEPWAVE web interface with the 'Advanced' tab selected. The 'Outbound Policy' section is active, and the 'Add a New Custom Rule' dialog box is open. The dialog box contains the following fields and options:

- Service Name:** to_internet
- Enable:**
- Source:** IP Address (dropdown), 192.168.50.10
- Destination:** Any (dropdown)
- Protocol:** Any (dropdown), <::: Protocol Selection ::> (dropdown)
- Algorithm:** Priority (dropdown)
- Priority Order:**

Highest Priority	Not In Use
Cloud: SFC (1 - Defau...	
Cloud: SFC (2 - WAN ...	
WAN: WAN 1	
WAN: WAN 2	
WAN: Cellular 1	
WAN: Cellular 2	
WAN: Cellular 3	
WAN: Cellular 4	
WAN: USB	
WAN: Wi-Fi WAN	
WAN: LAN 1 as WAN	
WAN: LAN 2 as WAN	
WAN: LAN 3 as WAN	
Lowest Priority	
- When No Connections are Available:** Drop the Traffic (dropdown)
- Terminate Sessions on Connection Recovery:** Enable

Buttons: Save, Cancel

Outbound Policy ?

Custom ✎

Rules 👤 Drag and drop rows by the left to change rule order ?

Service	Algorithm	Source	Destination	Protocol / Port	
PepVPN / OSPF / BGP / RIPv2 Routes SpeedFusion Cloud Routes					
to internet	Priority VPN: SFC (1 - Def...	IP Address 192.168.50.10	Any	Any	✖
HTTPS Persistence	Persistence (Src) (Auto)	Any	Any	TCP 443	✖
Default	(Auto)				
Add Rule					

Expert Mode ?

Enabled ✎

12.3 Connect Clients to Cloud

SpeedFusion Cloud provides a convenient way to route the LAN client to the cloud. From **SpeedFusion Cloud > Connect Clients to Cloud**.

peplink Dashboard Setup Wizard **SpeedFusion Cloud** Network AP System Status Apply Changes

SpeedFusion Cloud

Aggregate your bandwidth, connect you to different geo-location, and more.

- Setup Home Sharing**
Allow remote peers to access local networks, and the internet via this device.
- Choose Cloud Location**
Which cloud you'd like to connect?

— Traffic Steering Priority —

- Connect Clients to Cloud**
Select a cloud for your laptops, phones, or other devices.

Logout

Choose a client from the drop down list > Click + > Save > Apply Changes.

SpeedFusion Cloud > Connect Clients to Cloud

Traffic from the selected clients will be redirected to the assigned cloud.

Client	IP Address	
Automatic		
MY-Room-A-DellPC (40:23:43:26:F7:93)	192.168.52.179	✖
---		+

Save

12.4 Link Wi-Fi to Cloud

SpeedFusion Cloud provides a convenient way to route the Wi-Fi client to the cloud from **SpeedFusion Cloud > Link Wi-Fi to Cloud**. This option is available for **Balance 20X, Balance 30 Pro, and Balance One**.

SpeedFusion Cloud

Aggregate your bandwidth, connect you to different geo-location, and more.

- Setup Home Sharing**
Allow remote peers to access local networks, and the internet via this device.
- Choose Cloud Location**
Which cloud you'd like to connect?

— Traffic Steering Priority —

- Connect Clients to Cloud**
Select a cloud for your laptops, phones, or other devices.
- Link Wi-Fi to Cloud**
Create a Wi-Fi SSID that is dedicated for the cloud.

Logout

Create a new SSID for SpeedFusion Cloud. The new SSID will inherit all settings from one of the existing SSIDs including the Security Policy. Then click **Save** follow by **Apply Changes**.

SpeedFusion Cloud > Link Wi-Fi to Cloud

The new SSID will inherit all settings from the existing SSID including the Security Policy.

SpeedFusion Cloud	
Reference SSID	SSID for Cloud
Home	Home_SFC

Save

SpeedFusion Cloud SSID will be shown on **Dashboard**.

LAN Interface

Router IP Address: 192.168.54.1

Wi-Fi AP ON ▾ Details

📶 HomeBunker	📶 Home	📶 Home_SFC
--------------	--------	------------

12.5 Optimize Cloud Application

Optimize Cloud Application allows you to route Internet traffic through SpeedFusion Cloud based on the application. Go to **SpeedFusion Cloud > Optimize Cloud Application**.



The screenshot shows the Peplink SpeedFusion Cloud management interface. At the top, there is a navigation bar with the following tabs: Dashboard, Setup Wizard, SpeedFusion Cloud (highlighted), Network, AP, System, Status, and Apply Changes. Below the navigation bar, the main content area is titled "SpeedFusion Cloud" with a sub-header "Aggregate your bandwidth, connect you to different geo-location, and more." There are three main sections:

- Setup Home Sharing**: Allow remote peers to access local networks, and the internet via this device.
- Choose Cloud Location**: Which cloud you'd like to connect?

Below these sections is a section titled "Traffic Steering Priority" which contains three items:

- Connect Clients to Cloud**: Select a cloud for your laptops, phones, or other devices.
- Link Wi-Fi to Cloud**: Create a Wi-Fi SSID that is dedicated for the cloud.
- Optimize Cloud Application**: Connect to Google, Microsoft, Zoom and others using the Cloud. This item is highlighted with a red rectangular box.

On the left side of the interface, there is a sidebar with a "Logout" button.

Select a Cloud application to route through SpeedFusion Cloud from the drop down list > Click  > Save > Apply Changes. Click the  to remove a selected Cloud application from routing through SpeedFusion Cloud.

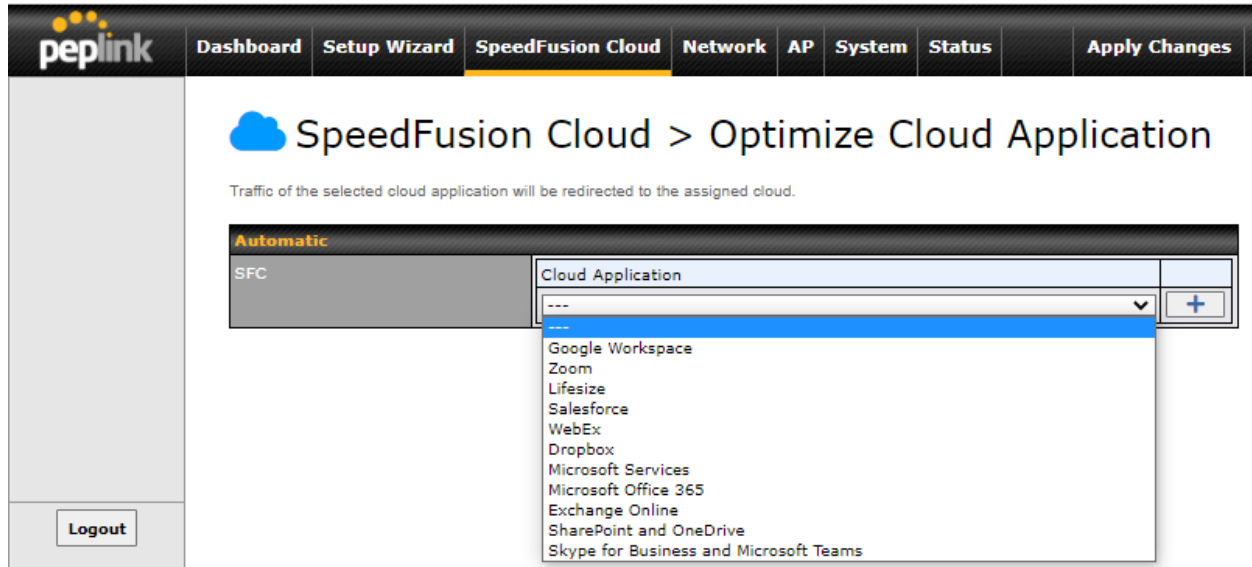

The screenshot shows the Peplink management interface. The top navigation bar includes 'Dashboard', 'Setup Wizard', 'SpeedFusion Cloud' (highlighted), 'Network', 'AP', 'System', 'Status', and 'Apply Changes'. The main content area is titled 'SpeedFusion Cloud > Optimize Cloud Application'. Below the title, a note states: 'Traffic of the selected cloud application will be redirected to the assigned cloud.' A table with the header 'Automatic' contains one row for 'SFC'. The 'Cloud Application' column of this row has a dropdown menu open, showing a list of applications: Google Workspace, Zoom, Lifesize, Salesforce, WebEx, Dropbox, Microsoft Services, Microsoft Office 365, Exchange Online, SharePoint and OneDrive, and Skype for Business and Microsoft Teams. A plus icon is visible to the right of the dropdown menu.

13 Network Tab

13.1 WAN

From **Network > WAN**, choose a WAN connection by clicking it.

WAN Connection Settings ?	
WAN Connection Name	WAN
Enable	<input type="checkbox"/>
Connection Method ?	DHCP ▼
Routing Mode ?	<input checked="" type="radio"/> NAT <input type="radio"/> IP Forwarding
Hostname (Optional) ?	<input type="text"/> <input type="checkbox"/> Use custom hostname
Management IP Address	<input type="text"/> 255.255.255.0 (/24) ▼
DNS Servers	<input checked="" type="checkbox"/> Obtain DNS server address automatically <input type="checkbox"/> Use the following DNS server address(es) DNS Server 1: <input type="text"/> DNS Server 2: <input type="text"/>
Connection Priority	<input checked="" type="radio"/> Always-on (Priority 1) <input type="radio"/> Backup
Independent from Backup WANs ?	<input type="checkbox"/>
Reply to ICMP Ping ?	<input checked="" type="radio"/> Yes <input type="radio"/> No
Upload Bandwidth ?	<input type="text"/> 100 Mbps ▼
Download Bandwidth ?	<input type="text"/> 100 Mbps ▼

IPv6

You can also enable IPv6 support in this section.

IPv6
Disabled

DNS over HTTPS (DoH)

You can enable the DoH support in this section.

DNS over HTTPS
Disabled

DNS over HTTPS ✕

Enable ?	<input checked="" type="checkbox"/>
Server	<div style="border: 1px solid black; padding: 2px;"> ▼ <ul style="list-style-type: none"> <li style="padding: 2px;">Cloudflare <li style="padding: 2px; background-color: #e0e0e0;">Cloudflare <li style="padding: 2px;">Quad9 <li style="padding: 2px;">Google DNS <li style="padding: 2px;">OpenDNS <li style="padding: 2px;">Custom URL: </div>

DNS over HTTPS	
Enable	When this option is enabled, the DNS proxy server will use HTTPS connections to forward DNS requests to the DoH resolver; it will not fallback to traditional UDP DNS options.
Server	<p>The options to configure DoH with a predefined server are:</p> <ul style="list-style-type: none"> Cloudflare - The DNS server IP addresses for Cloudflare will be using 1.1.1.1, which is unfiltered. Quad9 - The DNS server IP addresses for Quad9 will be using 9.9.9.9 and 142.112.112.112, which is malware blocking and DNSSEC. Google DNS - The DNS server IP addresses for Google DNS will be using 8.8.8.8 and 8.8.4.4, which is RFC8484 standard. OpenDNS - The DNS server IP addresses for OpenDNS will be using 208.67.222.222 and 208.67.220.220, which is standard DNS. Custom URL - You may select Custom URL:, and enter the resolver URL and IP address.

WAN Quality Monitoring

This settings advice how WAN Quality information is being gathered.

WAN Quality Monitoring ?

Auto	✎
------	---

By default, WAN Quality will always be observed and gathered automatically. With customized choice of WAN connections, the device will always observe WAN Quality of those selected WAN connections. Other WAN connections may stop observing WAN Quality information if it is not necessary for the underlying features.

WAN Connection Settings (Ethernet)

Clicking an Ethernet WAN connection will result in the following screen:

WAN Connection Settings	
WAN Connection Name	<input type="text" value="WAN"/>
Enable	<input checked="" type="checkbox"/> Always on ▼
Connection Method	<input type="text" value="DHCP"/> ▼
Routing Mode	<input checked="" type="radio"/> NAT
Hostname (Optional)	<input type="text"/> <input type="checkbox"/> Use custom hostname
DNS Servers	<input checked="" type="checkbox"/> Obtain DNS server address automatically <input type="checkbox"/> Use the following DNS server address(es) DNS Server 1: <input type="text"/> DNS Server 2: <input type="text"/>
IP Passthrough	<input type="checkbox"/>
Connection Priority	<input checked="" type="radio"/> Always-on (Priority 1) <input type="radio"/> Backup
Independent from Backup WANs	<input type="checkbox"/>
Reply to ICMP Ping	<input checked="" type="radio"/> Yes <input type="radio"/> No
Upload Bandwidth	<input type="text" value="1"/> Gbps ▼
Download Bandwidth	<input type="text" value="1"/> Gbps ▼

WAN Connection Settings																	
WAN Connection Name	Enter a name to represent this WAN connection.																
Enable	This setting enables the WAN connection. If schedules have been defined, you will be able to select a schedule to apply to the connection.																
Connection Method	<p>There are five possible connection methods for Ethernet WAN:</p> <ul style="list-style-type: none"> DHCP <table border="1"> <tr> <td>Connection Method</td> <td><input type="text" value="DHCP"/> ▼</td> </tr> <tr> <td>Routing Mode</td> <td><input checked="" type="radio"/> NAT</td> </tr> <tr> <td>Hostname (Optional)</td> <td><input type="text"/> <input type="checkbox"/> Use custom hostname</td> </tr> </table> Static IP <table border="1"> <tr> <td>Connection Method</td> <td><input type="text" value="Static IP"/> ▼</td> </tr> <tr> <td>Routing Mode</td> <td><input checked="" type="radio"/> NAT</td> </tr> <tr> <td>IP Address</td> <td><input type="text"/></td> </tr> <tr> <td>Subnet Mask</td> <td><input type="text" value="255.255.255.0 (/24)"/> ▼</td> </tr> <tr> <td>Default Gateway</td> <td><input type="text"/></td> </tr> </table> 	Connection Method	<input type="text" value="DHCP"/> ▼	Routing Mode	<input checked="" type="radio"/> NAT	Hostname (Optional)	<input type="text"/> <input type="checkbox"/> Use custom hostname	Connection Method	<input type="text" value="Static IP"/> ▼	Routing Mode	<input checked="" type="radio"/> NAT	IP Address	<input type="text"/>	Subnet Mask	<input type="text" value="255.255.255.0 (/24)"/> ▼	Default Gateway	<input type="text"/>
Connection Method	<input type="text" value="DHCP"/> ▼																
Routing Mode	<input checked="" type="radio"/> NAT																
Hostname (Optional)	<input type="text"/> <input type="checkbox"/> Use custom hostname																
Connection Method	<input type="text" value="Static IP"/> ▼																
Routing Mode	<input checked="" type="radio"/> NAT																
IP Address	<input type="text"/>																
Subnet Mask	<input type="text" value="255.255.255.0 (/24)"/> ▼																
Default Gateway	<input type="text"/>																

• **PPPoE**

Connection Method	PPPoE
Routing Mode	<input checked="" type="radio"/> NAT
PPPoE User Name	<input type="text"/>
PPPoE Password	<input type="text"/>
Confirm PPPoE Password	<input type="text"/>
Service Name (Optional)	<input type="text"/> <small>Leave it blank unless it is provided by ISP</small>
IP Address (Optional)	<input type="text"/> <small>Leave it blank unless it is provided by ISP</small>
Keep-Alive Interval	<input type="text" value="6"/> seconds(s)
Keep-Alive Retry	<input type="text" value="6"/>

• **L2TP**

Connection Method	L2TP
Routing Mode	<input checked="" type="radio"/> NAT
L2TP User Name	<input type="text"/>
L2TP Password	<input type="text"/>
Confirm L2TP Password	<input type="text"/>
Server IP Address / Host	<input type="text"/>
Address Type	<input checked="" type="radio"/> Dynamic IP <input type="radio"/> Static IP

• **GRE**

Connection Method	GRE
Routing Mode	<input checked="" type="radio"/> NAT
WAN IP Address	<input type="text"/>
WAN Subnet Mask	<input type="text" value="255.255.255.0"/> (/24)
WAN Default Gateway	<input type="text"/>
Remote GRE Host	<input type="text"/>
Tunnel Local IP Address	<input type="text"/>
Tunnel Remote IP Address	<input type="text"/>
Outgoing NAT IP Address	<input type="text"/>

The connection method and details are determined by, and can be obtained from the ISP. See the following sections for details on each connection method. DNS server settings can be configured in the corresponding menu for each connection method.

Routing Mode



icon.

Hostname (Optional)

If your service provider's DHCP server requires you to supply a hostname value upon acquiring an IP address, you may enter the value here. If your service provider does not provide you with a hostname, you can safely bypass this option.

<p>Management IP Address</p>	<p>Management IP Address is available for configuration when you click the link in the help  icon via the Hostname.</p> <p>This option allows you to configure the management IP address for the DHCP WAN connection.</p>
<p>DNS Servers</p>	<p>Each ISP may provide a set of DNS servers for DNS lookups. This setting specifies the DNS (Domain Name System) servers to be used when a DNS lookup is routed through this connection.</p> <p>Selecting Obtain DNS server address automatically results in the DNS servers assigned by the WAN DHCP server being used for outbound DNS lookups over the connection. (The DNS servers are obtained along with the WAN IP address assigned by the DHCP server.) When the following DNS server address(es) is selected, you may enter custom DNS server addresses for this WAN connection into the DNS server 1 and DNS server 2 fields.</p>
<p>Connection Priority</p>	<p>This option allows you to configure the WAN connection whether for normal daily usage or as a backup connection only.</p> <p>If Always-on is chosen, the WAN connection will be kept on continuously, regardless of the priority of other WAN connections.</p> <p>If Backup is chosen, the WAN connection will depend on other WAN connections. It will not be used when one or more higher priority dependent WAN connections are connected.</p>
<p>Independent from Backup WANs</p>	<p>If this is checked, the connection will be working independent from other Backup WAN connections. Those in Backup Priority will ignore the status of this WAN connection, and will be used when none of the other higher priority connections are available.</p>
<p>Reply to ICMP PING</p>	<p>If the checkbox is unticked, this option is disabled and the system will not reply to any ICMP ping echo requests to the WAN IP addresses of this WAN connection.</p> <p>Default: ticked (Yes)</p>
<p>Upload Bandwidth</p>	<p>This field refers to the maximum upload speed.</p> <p>This value is referenced when default weight is chosen for outbound traffic and traffic prioritization. A correct value can result in effective traffic prioritization and efficient use of upstream bandwidth.</p>
<p>Download Bandwidth</p>	<p>This field refers to the maximum download speed.</p> <p>Default weight control for outbound traffic will be adjusted according to this value.</p>

WAN Connection Settings (Cellular)



Clicking an Ethernet WAN connection will result in the following screens:

WAN Connection Settings ?	
WAN Connection Name	Cellular 1
Enable	<input checked="" type="checkbox"/>
Routing Mode ?	<input checked="" type="radio"/> NAT
DNS Servers	<input checked="" type="checkbox"/> Obtain DNS server address automatically <input type="checkbox"/> Use the following DNS server address(es) DNS Server 1: <input type="text"/> DNS Server 2: <input type="text"/>
Connection Priority	<input checked="" type="radio"/> Always-on (Priority 1) <input type="radio"/> Backup
Independent from Backup WANs ?	<input type="checkbox"/>
Standby State ?	<input checked="" type="radio"/> Remain connected <input type="radio"/> Disconnect
Idle Disconnect	<input type="checkbox"/>
Reply to ICMP Ping ?	<input checked="" type="radio"/> Yes <input type="radio"/> No

WAN Connection Settings	
WAN Connection Name	Indicate a name you wish to give this WAN connection
Enable	Click the checkbox to toggle the on and off state of this connection.
Routing Mode	<p>This option allows you to select the routing method to be used in routing IP frames via the WAN connection. The mode can be either NAT (Network Address Translation) or IP Forwarding.</p> <p>In the case if you need to choose IP Forwarding for your scenario. Click the ? button to enable IP Forwarding.</p>
DNS Servers	<p>Each ISP may provide a set of DNS servers for DNS lookups. This setting specifies the DNS (Domain Name System) servers to be used when a DNS lookup is routed through this connection.</p> <p>Selecting Obtain DNS server address automatically results in the DNS servers assigned by the WAN DHCP server being used for outbound DNS lookups over the connection. (The DNS servers are obtained along with the WAN IP address assigned by the DHCP server.) When Use the following DNS server address(es) is selected, you may enter custom DNS server addresses for this WAN connection into the DNS server 1 and DNS server 2 fields.</p>
Connection Priority	<p>This option allows you to configure the WAN connection whether for normal daily usage or as a backup connection only.</p> <p>If Always-on is chosen, the WAN connection will be kept on continuously, regardless of the priority of other WAN connections.</p> <p>If Backup is chosen, the WAN connection will depend on other WAN connections. It will not be used when one or more higher priority dependent WAN connections are connected.</p>

Independent from Backup WANs	If this is checked, the connection will be working independent from other Backup WAN connections. Those in Backup Priority will ignore the status of this WAN connection, and will be used when none of the other higher priority connections are available.
Idle Disconnect	If this is checked, the connection will disconnect when idle after the configured Time value. This option is disabled by default.
Reply to ICMP PING	If the checkbox is unticked , this option is disabled and the system will not reply to any ICMP ping echo requests to the WAN IP addresses of this WAN connection. Default: ticked (Yes)

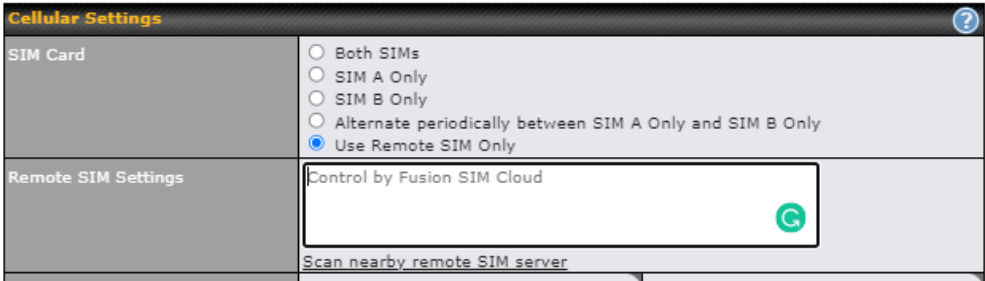
Cellular Settings ?		
SIM Card	<input checked="" type="radio"/> Both SIMs <input type="radio"/> SIM A Only <input type="radio"/> SIM B Only <input type="radio"/> Alternate periodically between SIM A Only and SIM B Only <input type="radio"/> Use Remote SIM Only	
Preferred SIM Card	<input checked="" type="radio"/> No preference <input type="radio"/> SIM A <input type="radio"/> SIM B	
	SIM Card A	SIM Card B
Carrier Selection ?	<input checked="" type="radio"/> Auto	<input checked="" type="radio"/> Auto
LTE/3G ?	Auto <input type="button" value="v"/>	Auto <input type="button" value="v"/>
Optimal Network Discovery ?	<input type="checkbox"/>	<input type="checkbox"/>
Band Selection	Auto <input type="button" value="v"/>	Auto <input type="button" value="v"/>
Data Roaming	<input type="checkbox"/>	<input type="checkbox"/>
Authentication	Auto <input type="button" value="v"/>	Auto <input type="button" value="v"/>
Operator Settings	<input checked="" type="radio"/> Auto <input type="radio"/> Custom	<input checked="" type="radio"/> Auto <input type="radio"/> Custom
APN	<input type="text"/>	<input type="text"/>
Username	<input type="text"/>	<input type="text"/>
Password	<input type="text"/>	<input type="text"/>
Confirm Password	<input type="text"/>	<input type="text"/>
SIM PIN (Optional) ?	<input type="text"/> <input type="text"/> (Confirm)	<input type="text"/> <input type="text"/> (Confirm)
Bandwidth Allowance Monitor ?	<input checked="" type="checkbox"/> Enable	<input type="checkbox"/> Enable
Action ?	Email notification is currently disabled. You can get notified when usage hits 75%/95% of monthly allowance by enabling Email Notification . <input checked="" type="checkbox"/> Disconnect when usage hits 100% of monthly allowance	Email notification is currently disabled. You can get notified when usage hits 75%/95% of monthly allowance by enabling Email Notification . <input checked="" type="checkbox"/> Disconnect when usage hits 100% of monthly allowance
Start Day ?	On <input type="text" value="1st"/> of each month at 00:00 midnight	On <input type="text" value="1st"/> of each month at 00:00 midnight
Monthly Allowance ?	<input type="text"/> GB <input type="button" value="v"/>	<input type="text"/> GB <input type="button" value="v"/>

Cellular Settings	
SIM Card	Indicate which SIM card this cellular WAN will use. Only applies to cellular WAN with redundant SIM cards. For routers that support the SIM Injector, you may select the "Use Remote SIM Only" to provision a SIM from a SIM Injector. Further details on the SIM Injector found is available here: https://www.peplink.com/products/sim-injector/ .
Preferred SIM Card	If "Both SIMs" were selected on the above field, then you can designate the priority of the SIM card slots here.
Remote SIM Settings	<p>If "Use Remote SIM Only" is selected in the SIM card section, the Remote SIM Settings will be shown.</p>  <p>You may need to enable the remote SIM Host settings in the Remote SIM management, see the section 13.14.7 or Appendix C for more details on FusionSIM. After that, click on "Scan nearby remote SIM server" to show the serial number(s) of the connected SIM Injector(s).</p> <p>If you want to select a specific SIM, in the Cellular Settings, type ":" and then the number of the SIM slot, eg.1111-2222-3333:7.</p>
LTE/3G	This drop-down menu allows restricting cellular to particular band. Click the  button to enable the selection of specific bands.
Optimal Network Discovery	Cellular WAsN by default will only handover from 3G to LTE network when there is no active data traffic, enable this option will make it run the handover procedures after fallback to 3G for a defined effective period, even this may interrupt the connectivity for a short while.
Band Selection	When set to Auto , band selection allows for automatically connecting to available, supported bands (frequencies) . When set to Manual, you can manually select the bands (frequencies) the SIM will connect to.
Data Roaming	This checkbox enables data roaming on this particular SIM card. When data roaming is enabled this option allows you to select in which countries the SIM has a data connection. The option is configured by using MMC (country) codes.Please check your service provider's data roaming policy before proceeding.
Authentication	Choose from PAP Only or CHAP Only to use those authentication methods exclusively. Select Auto to automatically choose an authentication method.
Operator Settings	This setting allows you to configure the APN settings of your connection. If Auto is selected, the mobile operator should be detected automatically. The connected device will be configured and connection will be made automatically. If there is any difficulty in making connections, you may select Custom to enter your carrier's APN, Login, Password , and

	Dial Number settings manually. The correct values can be obtained from your carrier. The default and recommended setting is Auto .
APN / Login / Password / SIM PIN	When Auto is selected, the information in these fields will be filled automatically. Select Custom to customize these parameters. The parameter values are determined by and can be obtained from the ISP.
Bandwidth Allowance Monitor	Check the box Enable to enable bandwidth usage monitoring on this WAN connection for each billing cycle. When this option is not enabled, bandwidth usage of each month is still being tracked but no action will be taken.
Action	If email notification is enabled, you will be notified by email when usage hits 75% and 95% of the monthly allowance. If Disconnect when usage hits 100% of monthly allowance is checked, this WAN connection will be disconnected automatically when the usage hits the monthly allowance. It will not resume connection unless this option has been turned off or the usage has been reset when a new billing cycle starts.
Start Day	This option allows you to define which day of the month each billing cycle begins.
Monthly Allowance	This field is for defining the maximum bandwidth usage allowed for the WAN connection each month.

Signal Threshold Settings

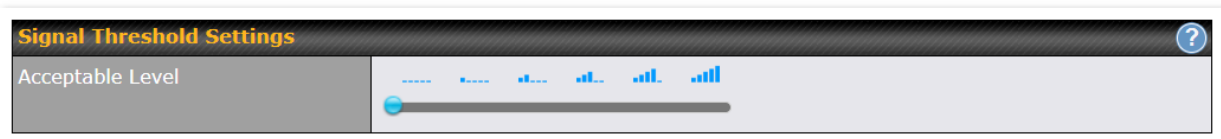

If signal threshold is defined, this connection will be treated as down when a weaker than threshold signal is determined.

The following values are used by the threshold scale:

	0 bars	1 bar	2 bars	3 bars	4 bars	5 bars
LTE / RSRP	-140	-128	-121	-114	-108	-98
3G / RSSI	-120	-100	-95	-90	-85	-75

To define the threshold manually using specific signal strength values, please click on the question Mark and the following field will be visible.

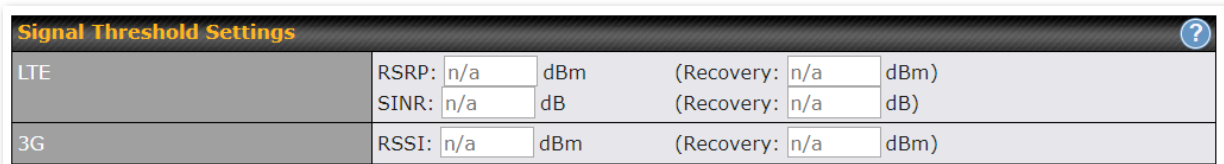

WAN Connection Settings (USB)

WAN Connection Settings	
WAN Connection Name	Mobile Internet
Enable	<input checked="" type="checkbox"/> Always on
DNS Servers	<input checked="" type="checkbox"/> Obtain DNS server address automatically <input type="checkbox"/> Use the following DNS server address(es) DNS Server 1: <input type="text"/> DNS Server 2: <input type="text"/>
Connection Priority	<input type="radio"/> Always-on (Priority 1) <input checked="" type="radio"/> Backup Priority 2
Standby State	<input checked="" type="radio"/> Remain connected <input type="radio"/> Disconnect
Idle Disconnect	<input type="checkbox"/>
Reply to ICMP Ping	<input checked="" type="radio"/> Yes <input type="radio"/> No

WAN Connection Settings	
WAN Connection Name	Indicate a name you wish to give this WAN connection
Enable	This setting enables the WAN connection. If schedules have been defined, you will be able to select a schedule to apply to the connection.
DNS Server	<p>Each ISP may provide a set of DNS servers for DNS lookups. This setting specifies the DNS (Domain Name System) servers to be used when a DNS lookup is routed through this connection.</p> <p>Selecting Obtain DNS server address automatically results in the DNS servers assigned by the WAN DHCP server being used for outbound DNS lookups over the connection. (The DNS servers are obtained along with the WAN IP address assigned by the DHCP server.) When Use the following DNS server address(es) is selected, you may enter custom DNS server addresses for this WAN connection into the DNS server 1 and DNS server 2 fields.</p>
Connection Priority	<p>This option allows you to configure the WAN connection whether for normal daily usage or as a backup connection only.</p> <p>If Always-on is chosen, the WAN connection will be kept on continuously, regardless of the priority of other WAN connections.</p> <p>If Backup is chosen, the WAN connection will depend on other WAN connections. It will not be used when one or more higher priority dependent WAN connections are connected.</p>
Standby State	This option allows you to choose whether to remain the connection connected or disconnect it when this WAN connection is no longer in the highest priority and has entered the standby state.
Idle Disconnect	If this is checked, the connection will disconnect when idle after the configured Time value. This option is disabled by default.
Reply to ICMP Ping	<p>If the checkbox is unticked, this option is disabled and the system will not reply to any ICMP ping echo requests to the WAN IP addresses of this WAN connection.</p> <p>Default: ticked (Yes)</p>

By default, the USB port is “USB Modem” mode. If you need to use it to connect to USB Ethernet Adapter, you need to change it to “USB Ethernet” mode, by enabling the hidden feature . Once this feature is enabled, the interface will behave as normal Ethernet WAN. The options that are the same as the ethernet WAN connection configuration are shown in the Ethernet WAN section.

Modem Settings	
Operator Settings	<input checked="" type="radio"/> Auto <input type="radio"/> Custom
APN	<input type="text"/>
Username	<input type="text"/>
Password	<input type="text"/>
Confirm Password	<input type="text"/>
Dial Number	<input type="text"/>
SIM PIN (Optional)	<input type="text"/> (Confirm)

ModemSettings	
Operator Settings	This setting allows you to configure the APN settings of your connection. If Auto is selected, the mobile operator should be detected automatically. The connected device will be configured and connection will be made automatically. If there is any difficulty in making connections, you may select Custom to enter your carrier's APN , Login , Password , and Dial Number settings manually. The correct values can be obtained from your carrier. The default and recommended setting is Auto .
APN / Login / Password / SIM PIN	When Auto is selected, the information in these fields will be filled automatically. Select Custom to customize these parameters. The parameter values are determined by and can be obtained from the ISP.

WAN Connection Settings (Common)

The remaining WAN-related settings are common to both Ethernet and cellular WAN

Physical Interface Settings	
Port Speed	Auto <input type="text"/>
MTU	<input type="radio"/> Auto <input checked="" type="radio"/> Custom <input type="text" value="1440"/>
MSS	<input checked="" type="radio"/> Auto <input type="radio"/> Custom
MAC Address Clone	<input checked="" type="radio"/> Default <input type="radio"/> Custom <input type="text" value="10:56:CA:15:92:5D"/>
VLAN	<input type="checkbox"/>

Physical Interface Settings	
Speed	<p>This is the port speed of the WAN connection. It should be set to the same speed as the connected device in case of any port negotiation problems.</p> <p>When a static speed is set, you may choose whether to advertise its speed to the peer device or not. Advertise Speed is selected by default. You can choose not to advertise the port speed if the port has difficulty in negotiating with the peer device.</p> <p>Default: Auto</p>
MTU	<p>This field is for specifying the Maximum Transmission Unit value of the WAN connection. An excessive MTU value can cause file downloads stall shortly after connected. You may consult your ISP for the connection's MTU value. Default value is 1440.</p>
MSS	<p>This field is for specifying the Maximum Segment Size of the WAN connection.</p> <p>When Auto is selected, MSS will be depended on the MTU value. When Custom is selected, you may enter a value for MSS. This value will be announced to remote TCP servers for maximum data that it can receive during the establishment of TCP connections.</p> <p>Some Internet servers are unable to listen to MTU setting if ICMP is filtered by firewall between the connections.</p> <p>Normally, MSS equals to MTU minus 40. You are recommended to reduce the MSS only if changing of the MTU value cannot effectively inform some remote servers to size down data size.</p> <p>Default: Auto</p>
MAC Address Clone	<p>Some service providers (e.g. cable network) identify the client's MAC address and require client to always use the same MAC address to connect to the network. If it is the case, you may change the WAN interface's MAC address to the client PC's one by entering the PC's MAC address to this field. If you are not sure, click the Default button to restore to the default value.</p>
VLAN	<p>Check the box to assign a VLAN to the interface.</p>

DHCP Settings	
Hostname (Optional)	<input type="text"/> <input type="checkbox"/> Use custom hostname
DNS Servers	<input checked="" type="checkbox"/> Obtain DNS server address automatically <input checked="" type="checkbox"/> Use the following DNS server address(es) DNS Server 1: <input type="text" value="1.1.1.1"/> DNS Server 2: <input type="text" value="8.8.8.8"/>

DHCP Settings	
Hostname (Optional)	<p>If your service provider's DHCP server requires you to supply a hostname value upon acquiring an IP address, you may enter the value here. If your service provider does not provide you with a hostname, you can safely bypass this option.</p>

Each ISP may provide a set of DNS servers for DNS lookups. This setting specifies the DNS (Domain Name System) servers to be used when a DNS lookup is routed through this connection.

DNS Servers

Selecting **Obtain DNS server address automatically** results in the DNS servers assigned by the WAN DHCP server being used for outbound DNS lookups over the connection. (The DNS servers are obtained along with the WAN IP address assigned by the DHCP server.) When **Use the following DNS server address(es)** is selected, you may enter custom DNS server addresses for this WAN connection into the **DNS server 1** and **DNS server 2** fields.

Health Check Settings

To ensure traffic is routed to healthy WAN connections only, the Peplink Balance can periodically check the health of each WAN connection.

Health Check settings for each WAN connection can be independently configured via **Network > Interfaces > WAN > *Connection name* > Health Check Settings**.

Enable Health Check by selecting PING, DNS Lookup, or HTTP from the Health Check Method drop-down menu.

Health Check Settings

Method

This setting specifies the health check method for the WAN connection. This value can be configured as **Disabled**, **PING**, **DNS Lookup**, or **HTTP**. The default method is **DNS Lookup**. For mobile Internet connections, the value of **Method** can be configured as **Disabled** or **SmartCheck**.

Health Check Disabled

Health Check Settings

Health Check Method	<div style="display: flex; align-items: center;"> ? <div style="border: 1px solid #ccc; padding: 2px;">Disabled</div> </div>
Health Check disabled. Network problem cannot be detected.	

When **Disabled** is chosen in the **Method** field, the WAN connection will always be considered as up. The connection will **NOT** be treated as down in the event of IP routing errors.

Health Check Method: PING

Health Check Method	<div style="display: flex; align-items: center;"> ? <div style="border: 1px solid #ccc; padding: 2px;">PING</div> </div>
PING Hosts	<div style="display: flex; align-items: flex-start;"> ? <div style="margin-right: 10px;">Host 1: <input style="width: 100%;" type="text"/></div> <div style="margin-right: 10px;">Host 2: <input style="width: 100%;" type="text"/></div> </div> <div style="margin-top: 5px;"> <input checked="" type="checkbox"/> Use first two DNS servers as PING Hosts </div>

ICMP ping packets will be issued to test the connectivity with a configurable target IP address or hostname. A WAN connection is considered as up if ping responses are received from either one or both of the ping hosts.

PING Hosts

This setting specifies IP addresses or hostnames with which connectivity is to be tested via ICMP ping. If **Use first two DNS servers as Ping Hosts** is checked, the target ping host will be the first DNS server for the corresponding WAN connection. Reliable ping hosts with a high uptime should be considered. By default, the first two DNS servers of the WAN connection are used as the ping hosts.

Health Check Method: DNS Lookup

Health Check Method	? DNS Lookup ▾
Health Check DNS Servers	? Host 1: <input type="text"/> Host 2: <input type="text"/> <input checked="" type="checkbox"/> Use first two DNS servers as Health Check DNS Servers <input type="checkbox"/> Include public DNS servers

DNS lookups will be issued to test connectivity with target DNS servers. The connection will be treated as up if DNS responses are received from one or both of the servers, regardless of whether the result was positive or negative.

Health Check DNS Servers

This field allows you to specify two DNS hosts' IP addresses with which connectivity is to be tested via DNS Lookup.

If **Use first two DNS servers as Health Check DNS Servers** is checked, the first two DNS servers will be the DNS lookup targets for checking a connection's health. If the box is not checked, **Host 1** must be filled, while a value for **Host 2** is optional.

If **Include public DNS servers** is selected and no response is received from all specified DNS servers, DNS lookups will also be issued to some public DNS servers. A WAN connection will be treated as down only if there is also no response received from the public DNS servers.

Connections will be considered as up if DNS responses are received from any one of the health check DNS servers, regardless of a positive or negative result. By default, the first two DNS servers of the WAN connection are used as the health check DNS servers.

Health Check Method: HTTP

Health Check Method	? HTTP ▾
URL 1	? http:// <input type="text"/> Matching String: <input type="checkbox"/>
URL 2	? http:// <input type="text"/> Matching String: <input type="checkbox"/>

HTTP connections will be issued to test connectivity with configurable URLs and strings to match.

URL1

WAN Settings>WAN Edit>Health Check Settings>URL1

The URL will be retrieved when performing an HTTP health check. When **String to Match** is left blank, a health check will pass if the HTTP return code is between 200 and 299 (Note: HTTP redirection codes 301 or 302 are treated as failures). When **String to Match** is filled, a health check will pass if the HTTP return code is between 200 and 299 and if the HTTP response content contains the string.

URL 2

WAN Settings>WAN Edit>Health Check Settings>URL2

If **URL2** is also provided, a health check will pass if either one of the tests passed.

Other Health Check Settings	
Timeout	<input type="text" value="5"/> second(s)
Health Check Interval	<input type="text" value="5"/> second(s)
Health Check Retries	<input type="text" value="3"/>
Recovery Retries	<input type="text" value="3"/>

Timeout	This setting specifies the timeout in seconds for ping/DNS lookup requests. The default timeout is 5 seconds .
Health Check Interval	This setting specifies the time interval in seconds between ping or DNS lookup requests. The default health check interval is 5 seconds .
Health Check Retries	This setting specifies the number of consecutive ping/DNS lookup timeouts after which the Peplink Balance will treat the corresponding WAN connection as down. Default health retries is set to 3 . Using the default Health Retries setting of 3 , the corresponding WAN connection will be treated as down after three consecutive timeouts.
Recovery Retries	This setting specifies the number of consecutive successful ping/DNS lookup responses that must be received before the Peplink Balance treats a previously down WAN connection as up again. By default, Recover Retries is set to 3 . Using the default setting, a WAN connection that is treated as down will be considered as up again upon receiving three consecutive successful ping/DNS lookup responses.

Note

If a WAN connection goes down, all of the WAN connections not set with a **Connection Type** of **Always-on** will also be brought up until any one of higher priority WAN connections is up and found to be healthy. This design could increase overall network availability.

For example, if WAN1, WAN2, and WAN3 have connection types of **Always-on**, **Backup Priority Group 1**, and **Backup Priority Group 2**, respectively, when WAN1 goes down, WAN2 and WAN3 will try to connect. If WAN3 is connected first, WAN2 will still be kept connecting. If WAN2 is connected, WAN3 will disconnect or stop connecting.

Automatic Public DNS Server Check on DNS Test Failure

When the health check method is set to **DNS Lookup** and checks fail, the Balance will automatically perform DNS lookups on some public DNS servers. If the tests are successful, the WAN may not be down, but rather the target DNS server malfunctioned. You will see the following warning message on the main page:

⚠ Failed to receive DNS response from the health-check DNS servers for WAN connection 3. But public DNS server lookup test via the WAN passed. So please check the DNS server settings.

Bandwidth Allowance Monitor Settings

Bandwidth Allowance Monitor Settings	
Bandwidth Allowance Monitor	<input checked="" type="checkbox"/> Enable
Action	<input type="checkbox"/> Email notification is currently disabled. You can get notified when usage hits 75%/95% of monthly allowance by enabling Email Notification . <input checked="" type="checkbox"/> Disconnect when usage hits 100% of monthly allowance
Start Day	On <input type="text" value="1st"/> of each month at 00:00 midnight
Monthly Allowance	<input type="text"/> GB

Bandwidth Allowance Monitor	
Action	<p>If Email Notification is enabled, you will be notified by email when usage hits 75% and 95% of the monthly allowance.</p> <p>If Disconnect when usage hits 100% of monthly allowance is checked, this WAN connection will be disconnected automatically when the usage hits the monthly allowance. It will not resume connection unless this option has been turned off or the usage has been reset when a new billing cycle starts.</p>
Start Day	This option allows you to define which day of the month each billing cycle begins.
Monthly Allowance	This field is for defining the maximum bandwidth usage allowed for the WAN connection each month.

Disclaimer

Due to different network protocol overheads and conversions, the amount of data reported by this Peplink device is not representative of actual billable data usage as metered by your network provider. Peplink disclaims any obligation or responsibility for any events arising from the use of the numbers shown here.

Additional Public IP Settings

Additional Public IP Address Settings	
Additional IP Address	<div style="border: 1px solid #ccc; padding: 5px;"> <p>IP Address <input type="text"/></p> <p>Subnet Mask <input type="text" value="255.255.255.255 (/32)"/></p> <p style="text-align: center;">↓</p> <div style="border: 1px solid #ccc; height: 40px; width: 100%;"></div> <p style="text-align: right;">✕</p> </div> <p>Those settings will not be saved until the save button below has been pressed.</p>

Additional Public IP Settings

IP Address List

IP Address List represents the list of fixed Internet IP addresses assigned by the ISP in the event that more than one Internet IP address is assigned to this WAN connection. Enter the fixed Internet IP addresses and the corresponding subnet mask, and then click the **Down Arrow** button to populate IP address entries to the **IP Address List**.

Dynamic DNS Settings

Peplink Balance routers allow registering domain name relationships to dynamic DNS service providers. Through registration with dynamic DNS service provider(s), the default public Internet IP address of each WAN connection can be associated with a hostname. With dynamic DNS service enabled for a WAN connection, you can connect to your WAN's IP address externally even if its IP address is dynamic. You must register for an account from the listed dynamic DNS service providers before enabling this option.

If the WAN connection's IP address is a reserved private IP address (i.e., behind a NAT router), the public IP of each WAN will be automatically reported to the DNS service provider.

Either upon a change in IP addresses or every 23 days without link reconnection, the Peplink Balance will connect to the dynamic DNS service provider to update the provider's IP address records.

The settings for dynamic DNS service provider(s) and the association of hostname(s) are configured via **Network>Interfaces>WAN>*Connection name*>Dynamic DNS Settings**.

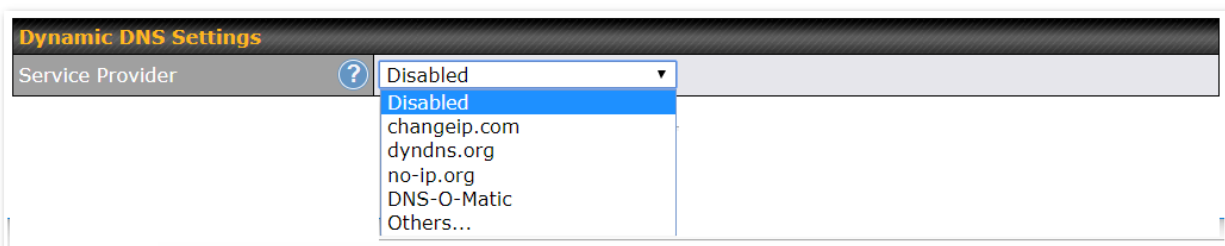

If your desired provider is not listed, you may check with **DNS-O-Matic**. This service supports updating 30 other dynamic DNS service providers. (Note: Peplink is not affiliated with DNS-O-Matic.)

Dynamic DNS Settings	
Service Provider	? DNS-O-Matic ▼
Username	<input type="text"/>
Password	<input type="password"/> 🔊
Confirm Password	<input type="password"/> 🔊
Update All Hosts	<input checked="" type="checkbox"/>

Dynamic DNS Settings	
Service Provider	<p>This setting specifies the dynamic DNS service provider to be used for the WAN. Supported providers are:</p> <ul style="list-style-type: none"> • changeip.com • dyndns.org • no-ip.org • tzo.com • DNS-O-Matic • Others... <p>support custom Dynamic DNS servers by entering its URL. Works with any service compatible with DynDNS API.</p> <p>Select Disabled to disable this feature.</p>
User ID / User / Email	This setting specifies the registered user name for the dynamic DNS service.
Password / Pass / TZO Key	This setting specifies the password for the dynamic DNS service.
Update All Hosts	Check this box to automatically update all hosts.
Hosts / IDs	This setting specifies a list of hostnames or domains to be associated with the public Internet IP address of the WAN connection.

Important Note

In order to use dynamic DNS services, appropriate hostname registration(s), as well as a valid account with a supported dynamic DNS service provider, are required.



A dynamic DNS update is performed whenever a WAN's IP address is changed, such as when an IP is changed after a DHCP IP refresh or reconnection.

Due to dynamic DNS service providers' policies, a dynamic DNS host expires automatically when the host record has not been updated for a long time. Therefore, the Peplink Balance performs an update every 23 days, even if a WAN's IP address did not change.

13.2 LAN

13.2.1 Network Settings

LAN interface settings are located at **Network>LAN>Network Settings**. Navigating to that page will show the following dashboard:

LAN	VLAN	Network	
LAN	None	172.16.251.1/24	
VLAN1	1	2.2.2.2/24	
VLAN2	2	3.3.3.3/24	

[New LAN](#)

This represents the LAN interfaces that are active on your router (including VLAN). A grey “X” means that the VLAN is used in other settings and cannot be deleted. You can find which settings are using the VLAN by hovering over the grey “X”.

Alternatively, a red “X” means that there are no settings using the VLAN. You can delete that VLAN by clicking the red “X”

Clicking on any of the existing LAN interfaces (or creating a new one) will show the following :

IP Settings

IP Address (/24) ▼

IP Settings

IP Address The IP address and subnet mask of the Pepwave router on the LAN.

Network Settings ?

Name	<input type="text"/>	Help Close To define a layer-2 bridging based PepVPN, please click here .
VLAN ID	<input type="text"/>	
Inter-VLAN routing	<input checked="" type="checkbox"/>	

Network Settings

Name	Enter a name for the LAN.
VLAN ID	Enter a number for your VLAN.
Inter-VLAN	Check this box to enable routing between virtual LANs.

routing

Layer 2 PepVPN Bridging		Help
PepVPN Profiles to Bridge	<input type="button" value="?"/> No profile is available	If you want to enable DHCP Option 82 Injection, please click here . This allow the device to inject Option 82 with Router Name information before forwarding the DHCP Request packet to PepVPN peer, such that the DHCP Server can identify where does this request come from.
Spanning Tree Protocol	<input type="checkbox"/>	
Override IP Address when bridge connected	<input checked="" type="radio"/> Do not override <input type="radio"/> Static <input type="radio"/> By DHCP <input type="radio"/> As None	
DHCP Server		



Layer 2 PepVPN Bridging	
PepVPN Profiles to Bridge	The remote network of the selected PepVPN profiles will be bridged with this local LAN, creating a Layer 2 PepVPN, they will be connected and operate like a single LAN, and any broadcast or multicast packets will be sent over the VPN.
Remote Network Isolation	Enable this option if you want to block network traffic between the remote networks, this will not affect the connectivity between them and this local LAN.
Spanning Tree Protocol	Click the box will enable STP for this layer 2 profile bridge.
Override IP Address when bridge connected	Select "Do not override" if the LAN IP address and local DHCP server should remain unchanged after the Layer 2 PepVPN is up. If you choose to override IP address when the VPN is connected, the device will not act as a router, and most Layer 3 routing functions will cease to work.
DHCP Option 82	Click on the question Mark if you want to enable DHCP Option 82. This allows the device to inject Option 82 with Router Name information before forwarding the DHCP Request packet to a PepVPN peer, such that the DHCP Server can identify where the request originates from.



DHCP Server			
DHCP Server	<input checked="" type="checkbox"/>	Enable	
DHCP Server Logging	<input type="checkbox"/>		
IP Range	<input type="text"/> - <input type="text"/>	255.255.255.0 (/24) ▼	
Lease Time	1	Days 0	Hours 0 Mins
DNS Servers	<input checked="" type="checkbox"/>	Assign DNS server automatically	
WINS Servers	<input type="checkbox"/>	Assign WINS server	
BOOTP	<input type="checkbox"/>		
Extended DHCP Option	Option	Value	
	<i>No Extended DHCP Option</i>		
	<input type="button" value="Add"/>		
DHCP Reservation	<input type="checkbox"/>	Name	MAC Address
			00:00:00:00:00:00

DHCP Server Settings	
DHCP Server	When this setting is enabled, the DHCP server automatically assigns an IP address to each computer that is connected via LAN and configured to obtain an IP address via DHCP. The Pepwave router's DHCP server can prevent IP address collision on the LAN.
DHCP Server Logging	Enable logging of DHCP events in the eventlog by selecting the checkbox.
IP Range & Subnet Mask	These settings allocate a range of IP addresses that will be assigned to LAN computers by the Pepwave router's DHCP server.
Lease Time	This setting specifies the length of time throughout which an IP address of a DHCP client remains valid. Upon expiration of the lease time, the assigned IP address will no longer be valid and renewal of the IP address assignment will be required.
DNS Servers	This option allows you to input the DNS server addresses to be offered to DHCP clients. If Assign DNS server automatically is selected, the Pepwave router's built-in DNS server address (i.e., LAN IP address) will be offered.
WINS Servers	This option allows you to optionally specify a Windows Internet Name Service (WINS) server. You may choose to use the built-in WINS server or external WINS servers . When this unit is connected using SpeedFusion™, other VPN peers can share this unit's built-in WINS server by entering this unit's LAN IP address in their DHCP WINS Server setting. Afterward, all PC clients in the VPN can resolve the NetBIOS names of other clients in remote peers. If you have enabled this option, a list of WINS clients will be displayed at Status>WINS Clients .
BOOTP	Check this box to enable BOOTP on older networks that still require it.
Extended DHCP Option	In addition to standard DHCP options (e.g., DNS server address, gateway address, subnet mask), you can specify the value of additional extended DHCP options, as defined in RFC 2132. With these extended options enabled, you can pass additional configuration information to LAN hosts. To define an extended DHCP option, click the Add button, choose the option to define and enter its value. For values that are in IP address list format, you can enter one IP address per line in the provided text area input control. Each option can be defined once only.

DHCP Reservation

This setting reserves the assignment of fixed IP addresses for a list of computers on the LAN. The computers to be assigned fixed IP addresses on the LAN are identified by their MAC addresses. The fixed IP address assignment is displayed as a cross-reference list between the computers' names, MAC addresses, and fixed IP addresses.

Name (an optional field) allows you to specify a name to represent the device. MAC addresses should be in the format of **00:AA:BB:CC:DD:EE**. Press  to create a new record. Press  to remove a record. Reserved client information can be imported from the **Client List**, located at **Status>Client List**. For more details, please refer to **Section 22.3**.

DHCP Relay Settings	
DHCP Relay	 <input checked="" type="checkbox"/> Enable
DHCP Server IP Address	DHCP Server 1: <input type="text"/> DHCP Server 2: <input type="text"/>
DHCP Option 82	 <input type="checkbox"/>
DHCP Relay Logging	<input type="checkbox"/>

DHCP Relay Settings	
DHCP Relay	Enter the address of the DHCP server here. DHCP requests will be relayed to it.
DHCP Server IP Address	DHCP requests from the LAN are relayed to the entered DHCP server. For active-passive DHCP server configurations, enter active and passive DHCP server IPs into the DHCP Server 1 and DHCP Server 2 fields.
DHCP Option 82	This feature includes device information as relay agent for the attached client when forwarding DHCP requests from a DHCP client to a DHCP server. Device MAC address and network name are embedded to circuit ID and Remote ID in option 82.
DHCP Relay Logging	Check this box to log DHCP relay activity.



13.2.2 Network Settings (Common Settings)

Static Route Settings			
Static Route	Destination Network	Subnet Mask	Gateway
	192.168.113.0	255.255.255.0 (/24) ▾	192.168.112.10
		255.255.255.0 (/24) ▾	

Static Route Settings





Static Route

This table is for defining static routing rules for the LAN segment. A static route consists of the network address, subnet mask, and gateway address. The address and subnet mask values are in w.x.y.z format.

The local LAN subnet and subnets behind the LAN will be advertised to the VPN. Remote routes sent over the VPN will also be accepted. Any VPN member will be able to route to the local subnet. Click  to create a new route. Click  to remove a route.

Entries in this list will allow traffic to route to a different subnet that is connected to the LAN interface. Any traffic destined for a network/mask pair will be directed to the corresponding gateway instead of routed through WANs.

^A - Advanced feature, please click the  button on the top right hand corner of the Static Route session to activate and configure Virtual Network Mapping to resolve network address conflict with remote peers.

Virtual Network Mapping			
One-to-One NAT		Local Network	Virtual Network
			
Many-to-One NAT		Local Network	Virtual IP Address
			

In case of a network address conflict with remote peers (i.e. PepVPN / IPsec VPN / IP Forwarding WAN are considered as remote connections), you can define Virtual Network Mapping to resolve it.

Note: OSPF & RIPv2 settings should be updated as well to avoid advertising conflicted networks.

For further details on virtual network mapping watch this video: <https://youtu.be/C1FMdZCn3Z8>

Virtual Network Mapping	
One-to-One NAT	Every IP Address in the Local Network has a corresponding unique Virtual IP Address for NAT. Traffic originating from the Local Network to remote connections will be SNAT'ed and behave like coming from the defined Virtual Network. While traffic initiated by remote peers to the Virtual Network will be DNAT'ed accordingly.
Many-to-One NAT	The subnet range defined in Local Network will be mapped to a single Virtual IP Address for NAT. Traffic can only be initiated from local to remote, and these traffic will be NAT'ed and behaves like coming from the same Virtual IP Address.



WINS Server Settings	
Enable	<input type="checkbox"/>

WINS Server Settings	
Enable	Check the box to enable the WINS Server. A list of WINS clients will be displayed at Status>WINS Clients .

Enter any needed DNS proxy settings. Once all settings have been entered, click **Save** to store your changes.



DNS Proxy Settings																			
Enable	<input checked="" type="checkbox"/>																		
DNS Caching	<input type="checkbox"/>																		
Include Google Public DNS Servers	<input type="checkbox"/>																		
Local DNS Records	<table border="1"> <thead> <tr> <th>Host Name</th> <th>IP Address</th> <th></th> </tr> </thead> <tbody> <tr> <td><input type="text"/></td> <td><input type="text"/></td> <td><input type="button" value="+"/></td> </tr> </tbody> </table>	Host Name	IP Address		<input type="text"/>	<input type="text"/>	<input type="button" value="+"/>												
Host Name	IP Address																		
<input type="text"/>	<input type="text"/>	<input type="button" value="+"/>																	
Domain Lookup Policy	<table border="1"> <thead> <tr> <th>Domain</th> <th>Connection</th> <th></th> </tr> </thead> <tbody> <tr> <td><input type="text"/></td> <td><input type="text"/></td> <td><input type="button" value="+"/></td> </tr> </tbody> </table>	Domain	Connection		<input type="text"/>	<input type="text"/>	<input type="button" value="+"/>												
Domain	Connection																		
<input type="text"/>	<input type="text"/>	<input type="button" value="+"/>																	
DNS Resolvers	<table border="1"> <thead> <tr> <th>WAN Connection</th> <th>DNS Servers</th> </tr> </thead> <tbody> <tr> <td><input type="checkbox"/> WAN 1</td> <td>1.1.1.1 1.0.0.1</td> </tr> <tr> <td><input type="checkbox"/> WAN 2</td> <td></td> </tr> <tr> <td><input type="checkbox"/> WAN 3</td> <td></td> </tr> <tr> <td><input type="checkbox"/> WAN 4</td> <td>8.8.8.8 8.8.4.4</td> </tr> <tr> <td><input type="checkbox"/> WAN 5</td> <td></td> </tr> <tr> <td><input type="checkbox"/> Mobile Internet</td> <td></td> </tr> <tr> <th>LAN Connection</th> <th>DNS Servers</th> </tr> <tr> <td><input type="checkbox"/> Untagged LAN</td> <td><input type="text"/> <input type="text"/></td> </tr> </tbody> </table> <p>Preferred connections are shown with <input checked="" type="checkbox"/></p>	WAN Connection	DNS Servers	<input type="checkbox"/> WAN 1	1.1.1.1 1.0.0.1	<input type="checkbox"/> WAN 2		<input type="checkbox"/> WAN 3		<input type="checkbox"/> WAN 4	8.8.8.8 8.8.4.4	<input type="checkbox"/> WAN 5		<input type="checkbox"/> Mobile Internet		LAN Connection	DNS Servers	<input type="checkbox"/> Untagged LAN	<input type="text"/> <input type="text"/>
WAN Connection	DNS Servers																		
<input type="checkbox"/> WAN 1	1.1.1.1 1.0.0.1																		
<input type="checkbox"/> WAN 2																			
<input type="checkbox"/> WAN 3																			
<input type="checkbox"/> WAN 4	8.8.8.8 8.8.4.4																		
<input type="checkbox"/> WAN 5																			
<input type="checkbox"/> Mobile Internet																			
LAN Connection	DNS Servers																		
<input type="checkbox"/> Untagged LAN	<input type="text"/> <input type="text"/>																		

DNS Proxy Settings	
Enable	To enable the DNS proxy feature, check this box, and then set up the feature at Network>LAN>DNS Proxy Settings .
DNS Caching	A DNS proxy server can be enabled to serve DNS requests originating from LAN/PPTP/SpeedFusion™ peers. Requests are forwarded to the DNS servers/resolvers defined for each WAN connection. This field is to enable DNS caching on the built-in DNS proxy server. When the option is enabled, queried DNS replies will be cached until the records' TTL has been reached. This feature can improve DNS response time by storing all received DNS results for faster DNS lookup. However, it cannot return the most updated result for frequently updated DNS records. By default, DNS Caching is disabled.

Include Google Public DNS Servers	When this option is enabled, the DNS proxy server will forward DNS requests to Google's public DNS servers, in addition to the DNS servers defined in each WAN. This could increase the DNS service's availability. This setting is disabled by default.
Local DNS Records	This table is for defining custom local DNS records. A static local DNS record consists of a host name and IP address. When looking up the host name from the LAN to LAN IP of the Peplink Balance, the corresponding IP address will be returned. To display the option to set TTL manually, click  . Click  to create a new record. Click  to remove a record.
Domain Lookup Policy	DNS proxy will look up the domain names defined here using only the specified connections.
DNS Resolvers^A	Check the box to enable the WINS server. A list of WINS clients will be displayed at Network>LAN>DNS Proxy Settings>DNS Resolvers . This field specifies which DNS resolvers will receive forwarded DNS requests. If no WAN/VPN/LAN DNS resolver is selected, all of the WAN's DNS resolvers will be selected. If a SpeedFusion™ peer is selected, you may enter the VPN peer's DNS resolver IP address(es). Queries will be forwarded to the selected connections' resolvers. If all of the selected connections are down, queries will be forwarded to all resolvers on healthy WAN connections.

^A - Advanced feature, please click the  button on the top right-hand corner to activate.

Finally, if needed, configure your Bonjour forwarding settings. Once all settings have been entered, click **Save** to store your changes.

Bonjour Forwarding Settings	
Enable	Check this box to turn on Bonjour forwarding.
Bonjour Service	Choose Service and Client networks from the drop-down menus, and then click  to add the networks. To delete an existing Bonjour listing, click  . Bonjour Forwarding is supported on All Balance models, MAX 700, HD2, HD4

Drop-In Mode

Drop-in mode (or transparent bridging mode) eases the installation of the Peplink Balance on a live network between the firewall and router, such that changes to the settings of existing equipment are not required.

The following diagram illustrates drop-in mode setup:

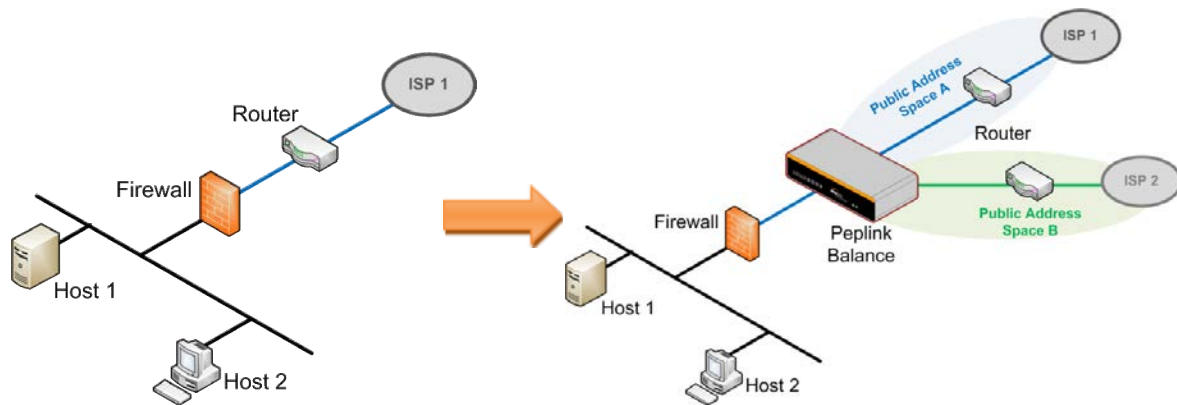

Enable drop-in mode using the Setup Wizard. After enabling this feature and selecting the WAN for drop-in mode, various settings, including the WAN's connection method and IP address, will be automatically updated.

When drop-in mode is enabled, the LAN and the WAN for drop-in mode ports will be bridged. Traffic between the LAN hosts and WAN router will be forwarded between the devices. In this case, the hosts on both sides will not notice any IP or MAC address changes.

After successfully setting up the Peplink Balance as part of the network using drop-in mode, it will, depending on model, support one or more WAN connections. Some MediaFast units also support multiple WAN connections after activating drop-in mode, though a SpeedFusion license may be required to activate more than one WAN port.

Please note the Drop-In Mode is mutually exclusive with VLAN.

Drop-In Mode Settings ?	
Enable	<input checked="" type="checkbox"/>
WAN for Drop-In Mode	? WAN 1 ▾
Share Drop-In IP	? <input checked="" type="checkbox"/>
Shared IP Address	? <input type="text"/> 255.255.255.0 (/24) ▾
WAN Default Gateway	? <input type="text"/> <input checked="" type="checkbox"/> I have other host(s) on WAN segment Host IP Address(es) <input type="text"/> - <input type="text"/> <input type="button" value="↓"/> <input type="text"/> <input type="button" value="Delete"/>
WAN DNS Servers	? DNS server 1: <input type="text"/> DNS server 2: <input type="text"/>
<p>NOTE: The DHCP Server Settings will be overwritten.</p> <p>The following WAN 1 settings will be overwritten: Connection Method, MTU, Health Check, Additional Public IP, and Dynamic DNS Settings.</p> <p>The PPTP Server will be disabled.</p> <p>Tip: please review the DNS Forwarding setting under the Service Forwarding section.</p>	

Drop-in Mode Settings	
Enable	<p>Drop-in mode eases the installation of the Peplink Balance on a live network between the existing firewall and router, such that no configuration changes are required on existing equipment. Check the box to enable the drop-in mode feature.</p> <p>Please refer to Section 12, Drop-in Mode for details.</p>
WAN for Drop-In Mode	<p>Select the WAN port to be used for drop-in mode. If WAN 1 with LAN Bypass is selected, the high availability feature will be disabled automatically.</p>
Shared Drop-In IP^A	<p>When this option is enabled, the passthrough IP address will be used to connect to WAN hosts (email notification, remote syslog, etc.). The Balance will listen for this IP address when WAN hosts access services provided by the Balance (web admin access from the WAN, DNS server requests, etc.).</p> <p>To connect to hosts on the LAN (email notification, remote syslog, etc.), the default gateway address will be used. The Balance will listen for this IP address when LAN hosts access services provided by the Balance (web admin access from the WAN, DNS proxy, etc.).</p>
Shared IP Address^A	<p>Access to this IP address will be passed through to the LAN port if this device is not serving the service being accessed. The shared IP address will be used in connecting to hosts on the WAN (e.g., email notification, remote syslog, etc.) The device will also listen on the IP address when hosts on the WAN access services served on this device (e.g., web admin accesses from WAN, DNS server, etc.)</p>
WAN Default	<p>Enter the WAN router's IP address in this field. If there are more hosts in addition to the router on the WAN segment, click the ? button next to "WAN Default Gateway" and check</p>

Gateway	the I have other host(s) on WAN segment box and enter the IP address of the hosts that need to access LAN devices or be accessed by others.
WAN DNS Servers	Enter the selected WAN's corresponding DNS server IP addresses.

^A - Advanced feature, please click the button on the top right-hand corner to activate.

13.2.3 Port Settings

To configure port settings, navigate to **Network > Port Settings**

Port Settings						
	Name	Enable	Speed	Advertise Speed	Port Type	VLAN
1	LAN Port 1	<input checked="" type="checkbox"/>			Trunk ▼	Any ▼
2	LAN Port 2	<input type="checkbox"/>	Auto ▼	<input checked="" type="checkbox"/>	Trunk ▼	Any ▼
3	LAN Port 3	<input checked="" type="checkbox"/>			Trunk ▼	Any ▼

This section allows you to:

- Enable or disable specific LAN ports
- Configure the negotiation speed of the LAN ports
- Configure the port type (Trunk or Access)
- Assign a VLAN to a LAN port (in Access mode)

13.3 VPN

13.3.1 SpeedFusion



Peplink Balance SpeedFusion™ Bandwidth Bonding is our patented technology that enables our SD-WAN routers to bond multiple Internet connections to increase site-to-site bandwidth and reliability. SpeedFusion securely connects one or more branch offices to your company's main headquarters or to other branches. The data, voice, and video communications between these locations are kept confidential across the public Internet.

The SpeedFusion™ of the Peplink Balance is specifically designed for multi-WAN environments. With SpeedFusion, in case of failures and network congestion at one or more WANs, other WANs can be used to continue carrying the network traffic. Peplink Balance routers can bond all WAN connections' bandwidth for routing SpeedFusion™ traffic. Unless all the WAN connections of one site are down, the Peplink Balance can keep the VPN up and running. Bandwidth bonding is enabled by default.

To begin, navigate to **Network > VPN > SpeedFusion** and enter a Local ID and click save.

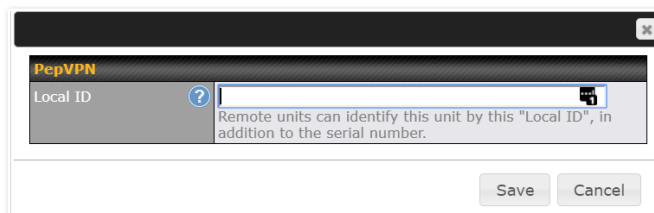

This device will be identified by other SpeedFusion Peers by this local ID. The following menus will appear:

Profile	Remote ID	Remote Address(es)	?
No VPN Connection Defined			
New Profile			

SpeedFusion Profiles

This table displays all defined profiles. Click the **New Profile** button to create a new profile for making a VPN connection to a remote unit via available WAN connections. Each pair of VPN connection requires its own profile.

The local LAN subnet and subnets behind the LAN (defined under Static Route on the LAN Settings page) will be advertised to the VPN. All VPN members will be able to route to local subnets.

Send All Traffic To

No PepVPN profile selected

Send All Traffic To

This feature allows you to redirect all traffic to a specified PepVPN connection. Click the  button to select your connection and the following menu will appear:

You could also specify a DNS server to resolve incoming DNS requests. Click the checkbox next to **Backup Site** to designate a backup SpeedFusion profile that will take over should the main PepVPN connection fail.

PepVPN Local ID

Local ID



Balance_01AA



PepVPN Local ID

This feature allows you to change the local ID of a PepVPN connection. Click the  button to select your connection and the following menu will appear:

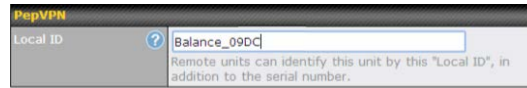

After updating the local ID, click **Save** to store your changes.

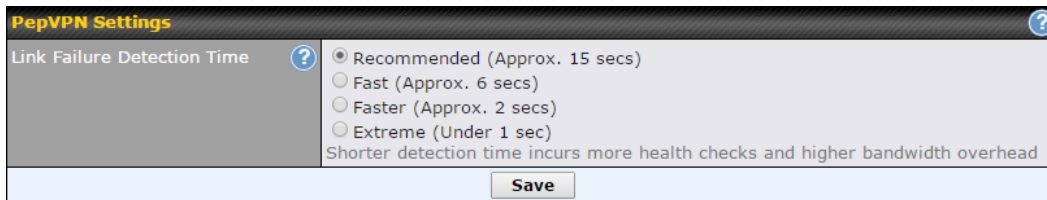

Link Failure Detection

The bonded VPN can detect routing failures on the path between two sites over each WAN connection. Failed WAN connections will not be used to route VPN traffic. Health check packets are sent to the remote unit to detect any failure. The more frequently checks are sent, the shorter the detection time, although more bandwidth will be consumed.

When **Recommended** (default) is selected, a health check packet is sent every five seconds, and the expected detection time is 15 seconds.

Link Failure Detection Time

When **Fast** is selected, a health check packet is sent every three seconds, and the expected detection time is six seconds.

When **Faster** is selected, a health check packet is sent every second, and the expected detection time is two seconds.

When **Extreme** is selected, a health check packet is sent every 0.1 second, and the expected detection time is less than one second.

Important Note

Peplink proprietary SpeedFusion™ uses TCP port 32015 and UDP port 4500 for establishing VPN connections. If you have a firewall in front of your Peplink Balance devices, you will need to add firewall rules for these ports and protocols to allow inbound and outbound traffic to pass through the firewall.

SpeedFusion: Profile Configuration

Click the **New Profile** button, or click one of the existing profiles, and the following menu will appear:

PepVPN Profile ?							
Name ?	<input type="text"/>						
Enable	<input checked="" type="checkbox"/>						
Encryption ?	<input checked="" type="radio"/> 256-bit AES <input type="radio"/> OFF						
Authentication	<input checked="" type="radio"/> Remote ID / Pre-shared Key <input type="radio"/> X.509						
Remote ID / Pre-shared Key ?	<table border="1"> <thead> <tr> <th>Remote ID</th> <th>Pre-shared Key</th> <th></th> </tr> </thead> <tbody> <tr> <td><input type="text"/></td> <td><input type="text"/></td> <td style="text-align: center;">+</td> </tr> </tbody> </table>	Remote ID	Pre-shared Key		<input type="text"/>	<input type="text"/>	+
Remote ID	Pre-shared Key						
<input type="text"/>	<input type="text"/>	+					
Allow shared Remote ID ?	<input type="checkbox"/>						
NAT Mode ?	<input type="checkbox"/>						
Remote IP Address / Host Names (Optional) ?	<input type="text"/> <small>If this field is empty, this field on the remote unit must be filled</small>						
Cost ?	<input type="text" value="10"/>						
Data Port ?	<input checked="" type="radio"/> Auto <input type="radio"/> Custom <input type="text"/>						
Bandwidth Limit ?	<input type="checkbox"/>						
WAN Smoothing ?	<input type="text" value="Off"/> ▼						
Forward Error Correction ?	<input type="text" value="Off"/> ▼						
Receive Buffer ?	<input type="text" value="0"/> ms						
Packet Fragmentation ?	<input checked="" type="radio"/> Always <input type="radio"/> Use DF Flag						
Use IP ToS	<input type="checkbox"/>						
Latency Difference Cutoff ?	<input type="text" value="500"/> ms						



A list of defined SpeedFusion connection profiles and a **Link Failure Detection Time** option will be shown. Click the **New Profile** button to create a new VPN connection profile for making a VPN connection to a remote Peplink Balance via the available WAN connections. Each profile is for making a VPN connection with one remote Peplink Balance.

PepVPN Profile Settings

Name

This field is for specifying a name to represent this profile. The name can be any combination of alphanumeric characters (0-9, A-Z, a-z), underscores (_), dashes (-), and/or non-leading/trailing spaces ().

Click the icon next to the **PepVPN Profile** title bar to use the IP ToS field of your data packet on PepVPN WAN traffic.

Enable	When this box is checked, this VPN connection profile will be enabled. Otherwise, it will be disabled.
Encryption	By default, VPN traffic is encrypted with 256-bit AES . If Off is selected on both sides of a VPN connection, no encryption will be applied.
Authentication	Select from By Remote ID Only , Preshared Key , or X.509 to specify the method the Peplink Balance will use to authenticate peers. When selecting By Remote ID Only , be sure to enter a unique peer ID number in the Remote ID field.
Remote ID / Pre-shared Key	<p>This optional field becomes available when Remote ID / Pre-shared Key is selected as the Peplink Balance's VPN Authentication method, as explained above. Pre-shared Key defines the pre-shared key used for this particular VPN connection. The VPN connection's session key will be further protected by the pre-shared key. The connection will be up only if the pre-shared keys on each side match. When the peer is running firmware 5.0+, this setting will be ignored.</p> <p>Enter Remote IDs either by typing out each Remote ID and Pre-shared Key, or by pasting a CSV. If you wish to paste a CSV, click the  icon next to the "Remote ID / Preshared Key" setting.</p>
Remote ID/Remote Certificate	These optional fields become available when X.509 is selected as the Peplink Balance's VPN authentication method, as explained above. To authenticate VPN connections using X.509 certificates, copy and paste certificate details into these fields. To get more information on a listed X.509 certificate, click the Show Details link below the field.
Allow Shared Remote ID	When this option is enabled, the router will allow multiple peers to run using the same remote ID.
NAT Mode	Check this box to allow the local DHCP server to assign an IP address to the remote peer. When NAT Mode is enabled, all remote traffic over the VPN will be tagged with the assigned IP address using network address translation.
Remote IP Address / Host Names (Optional)	<p>If NAT Mode is not enabled, you can enter a remote peer's WAN IP address or hostname(s) here. If the remote uses more than one address, enter only one of them here. Multiple hostnames are allowed and can be separated by a space character or carriage return. Dynamic-DNS host names are also accepted.</p> <p>This field is optional. With this field filled, the Peplink Balance will initiate connection to each of the remote IP addresses until it succeeds in making a connection. If the field is empty, the Peplink Balance will wait for connection from the remote peer. Therefore, at least one of the two VPN peers must specify this value. Otherwise, VPN connections cannot be established.</p> <p>Click the  icon to customize the handshake port of the remote Host (TCP)</p>
Cost	<p>Define path cost for this profile.</p> <p>OSPF will determine the best route through the network using the assigned cost.</p> <p>Default: 10</p>
Data Port	This field is used to specify a UDP port number for transporting outgoing VPN data. If Default is selected, UDP port 4500 will be used. Port 32015 will be used if the remote unit uses Firmware prior to version 5.4 or if port 4500 is unavailable. If Custom is selected, enter an outgoing port number from 1 to 65535.

	<p>Click the  icon to configure data stream using TCP protocol [EXPERIMENTAL]. In the case TCP protocol is used, the exposed TCP session option can be authorised to work with TCP accelerated WAN link.</p>
Bandwidth Limit	<p>Define maximum download and upload speed to each individual peer. This functionality requires the peer to use PepVPN version 4.0.0 or above.</p>
WAN Smoothing	<p>While using PepVPN, utilize multiple WAN links to reduce the impact of packet loss and get the lowest possible latency at the expense of extra bandwidth consumption. This is suitable for streaming applications where the average bitrate requirement is much lower than the WAN's available bandwidth.</p> <p>Off - Disable WAN Smoothing.</p> <p>Normal - The total bandwidth consumption will be at most 2x of the original data traffic.</p> <p>Medium - The total bandwidth consumption will be at most 3x of the original data traffic.</p> <p>High - The total bandwidth consumption depends on the number of connected active tunnels.</p>
Forward Error Correction	<p>Forward Error Correction (FEC) can help to recover packet loss by using extra bandwidth to send redundant data packets. Higher FEC level will recover packets on a higher loss rate link.</p> <p>The expected overhead of Low is 13.3% and High is 26.7%.</p> <p>Require peer using PepVPN version 8.0.0 and above.</p>
Receive Buffer	<p>Receive Buffer can help to reduce out-of-order packets and jitter, but will introduce extra latency to the tunnel. Default is 0 ms, which disables the buffer, and maximum buffer size is 2000 ms.</p>
Packet Fragmentation	<p>If the packet size is larger than the tunnel's MTU, it will be fragmented inside the tunnel in order to pass through.</p> <p>Select Always to fragment any packets that are too large to send, or Use DF Flag to only fragment packets with Don't Fragment bit cleared. This can be useful if your application does Path MTU Discovery, usually sending large packets with DF bit set, if allowing them to go through by fragmentation, the MTU will not be detected correctly.</p>
Use IP ToS^A	<p>If Use IP ToS is enabled, the ToS value of the data packets will be copied to the PepVPN header during encapsulation.</p>
Latency Difference Cutoff^A	<p>Traffic will be stopped for links that exceed the specified millisecond value with respect to the lowest latency link. (e.g. Lowest latency is 100ms, a value of 500ms means links with latency 600ms or more will not be used)</p>

^A - Advanced feature, please click the  button on the top right-hand corner to activate.

To enable Layer 2 Bridging between PepVPN profiles, navigate to **Network>LAN>*LAN Profile Name***

Traffic Distribution	
Policy	? Bonding ▼

Traffic Distribution	
Policy	? Dynamic Weighted Bonding ▼
Congestion Latency Level	? Default ▼
Ignore Packet Loss Event	? <input type="checkbox"/>
Disable Bufferbloat Handling	? <input type="checkbox"/>
Disable TCP ACK Optimization	? <input type="checkbox"/>
Packet Jitter Buffer	? 150 ms

Traffic Distribution	
Policy	<p>This option allows you to select the desired out-bound traffic distribution policy:</p> <ul style="list-style-type: none"> • Bonding - Aggregate multiple WAN-to-WAN links into a single higher throughput tunnel. • Dynamic Weighted Bonding - Aggregates WAN-to-WAN links with similar latencies. <p>By default, Bonding is selected as a traffic distribution policy.</p>
Congestion Latency Level	<p>For most WANs, especially on cellular networks, the latency will increase when the link becomes more congested.</p> <p>Setting the Congestion Latency Level to Low will treat the link as congested more aggressively.</p> <p>Setting it to High will allow the latency to increase more before treating it as congested.</p>
Ignore Packet Loss Event	<p>By default, when there is packet loss, it is considered as a congestion event. If this is not the case, select this option to ignore the packet loss event.</p>
Disable Bufferbloat Handling	<p>Bufferbloat is a phenomenon on the WAN side when it is congested. The latency can become very high due to buffering on the uplink. By default, the Dynamic Weighted Bonding policy will try its best to mitigate bufferbloat by reducing TCP throughput when the WAN is congested. However, as a side effect, the tunnel might not achieve maximum bandwidth.</p> <p>Selecting this option will disable the bufferbloat handling mentioned above.</p>
Disable TCP ACK Optimization	<p>By default, TCP ACK will be forwarded to remote peers as fast as possible. This will consume more bandwidth, but may help to improve TCP performance as well.</p> <p>Selecting this option will disable the TCP ACK optimization mentioned above.</p>
Packet Jitter Buffer	<p>The default jitter buffer is 150ms, and can be modified from 0ms to 500ms. The jitter buffer may increase the tunnel latency. If you want to keep the latency as low as possible, you can set it to 0ms to disable the buffer.</p> <p>Note: If the Receive Buffer is set, the Packet Jitter Buffer will be automatically disabled.</p>

WAN Connection Priority ?					
	Priority	Direction	Connect to Remote	Cut-off latency (ms)	Suspension Time after Packet Loss (ms)
1. WAN 1	1 (Highest) ▼	Up/Down ▼	All ▼	<input type="text"/>	<input type="text"/>
2. WAN 2	1 (Highest) ▼	Up/Down ▼	All ▼	<input type="text"/>	<input type="text"/>
3. Wi-Fi WAN	1 (Highest) ▼	Up/Down ▼	All ▼	<input type="text"/>	<input type="text"/>
4. Cellular 1	1 (Highest) ▼	Up/Down ▼	All ▼	<input type="text"/>	<input type="text"/>
5. Cellular 2	1 (Highest) ▼	Up/Down ▼	All ▼	<input type="text"/>	<input type="text"/>
6. USB	1 (Highest) ▼	Up/Down ▼	All ▼	<input type="text"/>	<input type="text"/>

WAN Connection Priority

WAN
Connection
Priority

If your device supports it, you can specify the priority of WAN connections to be used for making VPN connections. WAN connections set to **OFF** will never be used. Only available WAN connections with the highest priority will be used.

To enable asymmetric connections, connection mapping to remote WANs, cut-off latency, and packet loss suspension time, click the button.

Peplink also published a whitepaper about Speedfusion which can be downloaded from the following url:

<http://download.peplink.com/resources/whitepaper-speedfusion-and-best-practices-2019.pdf>

13.3.2 IPsec VPN

Peplink Balance IPsec VPN functionality securely connects one or more branch offices to your company's main headquarters or to other branches. Data, voice, and video communications between these locations are kept safe and confidential across the public Internet.

All Peplink products can make multiple IPsec VPN connections with Peplink routers, as well as Cisco and Juniper routers.

Note that all LAN subnets and the subnets behind them must be unique. Otherwise, VPN members will not be able to access each other.

All data can be routed over the VPN with a selection of encryption standards, such as 3DES, AES-128, and AES-256.

To configure, navigate to **Network > VPN > IPsec VPN**.

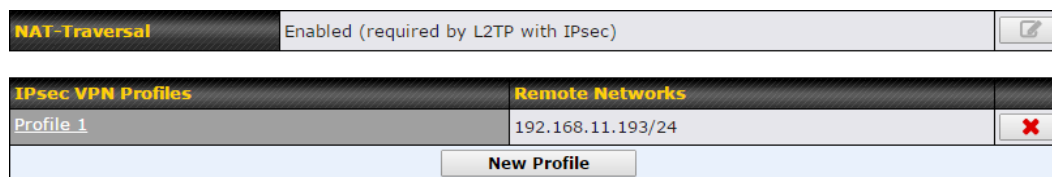

A **NAT-Traversal** option and list of defined **IPsec VPN** profiles will be shown.

NAT-Traversal should be enabled if your system is behind a NAT router.

Click the **New Profile** button to create new IPsec VPN profiles that make VPN connections to remote Peplink Balance, Cisco, or Juniper Routers via available WAN connections. To edit any of the profiles, click on its associated connection name in the leftmost column.

IPsec VPN Profile
✕

Name	<input type="text"/>								
Active ?	<input checked="" type="checkbox"/>								
IKE Version	<input checked="" type="radio"/> IKEv1 <input type="radio"/> IKEv2								
Connect Upon Disconnection of	<input checked="" type="checkbox"/> <input type="text" value="WAN 1"/>								
Remote Gateway IP Address / Host Name ?	<input type="text"/>								
IPsec Type ?	<input checked="" type="radio"/> Policy-based <input type="radio"/> Route-based								
Local Networks ?	Propose the following networks to remote gateway: <ul style="list-style-type: none"> <input checked="" type="checkbox"/> 192.168.50.0/24 <input type="checkbox"/> 192.168.101.0/24 <input type="checkbox"/> 192.168.102.0/24 <input type="checkbox"/> 192.168.103.0/24 <input type="checkbox"/> 192.168.104.0/24 <input type="checkbox"/> 192.168.105.0/24 <input type="checkbox"/> 172.16.1.0/24 <input type="checkbox"/> <input type="text"/> Apply the following NAT policies: <ul style="list-style-type: none"> <input type="checkbox"/> Local Network <input checked="" type="checkbox"/> NAT Network 								
Remote Networks	<table border="1" style="width: 100%; border-collapse: collapse;"> <thead> <tr> <th style="width: 60%;">Network</th> <th style="width: 20%;">Subnet Mask</th> <th style="width: 20%;"></th> </tr> </thead> <tbody> <tr> <td><input type="text"/></td> <td>255.255.255.0 (/24) ▾</td> <td style="text-align: center;">+</td> </tr> </tbody> </table>	Network	Subnet Mask		<input type="text"/>	255.255.255.0 (/24) ▾	+		
Network	Subnet Mask								
<input type="text"/>	255.255.255.0 (/24) ▾	+							
Authentication	<input checked="" type="radio"/> Preshared Key								
Mode	<input checked="" type="radio"/> Main Mode (All WANs need to have Static IP) <input type="radio"/> Aggressive Mode								
Force UDP Encapsulation ?	<input type="checkbox"/>								
Preshared Key	<input type="text"/> <input checked="" type="checkbox"/> Hide Characters								
Local ID ?	<input type="text"/>								
Remote ID ?	<input type="text"/>								
Phase 1 (IKE) Proposal	1 <input type="text" value="AES-256 & SHA1"/> ▾ 2 <input type="text" value="-----"/> ▾								
Phase 1 DH Group ?	1 <input type="text" value="Group 2"/> ▾ 2 <input type="text" value="-----"/> ▾								
Phase 1 SA Lifetime	<input type="text" value="3600"/> seconds								
Phase 2 (ESP) Proposal	1 <input type="text" value="AES-256 & SHA1"/> ▾ 2 <input type="text" value="-----"/> ▾								
Phase 2 PFS Group	<input type="text" value="None"/> ▾								
Phase 2 SA Lifetime	<input type="text" value="28800"/> seconds								

IPsec VPN Settings	
Name	This field is for specifying a local name to represent this connection profile.
Active	When this box is checked, this IPsec VPN connection profile will be enabled. Otherwise, it will be disabled.
IKE Version	Two versions of the IKE standards are available: <ul style="list-style-type: none"> • IKEv1 • IKEv2
Connect Upon Disconnection of	Check this box and select a WAN to connect to this VPN automatically when the specified WAN is disconnected. To activate this function, click the  button next to the "Active" option.
Remote Gateway IP Address / Host Name	Enter the remote peer's public IP address. For Aggressive Mode , this is optional.
IPsec Type	<p>Policy-based - (default) All the matched traffic as defined in Local Networks and Remote Networks will be routed to this IPsec connection, this cannot be overridden by other routing methods.</p> <p>Route-based - Outbound Policy rule is required to route traffic to this tunnel and comes with more flexibility to control how to route traffic compared to Policy-based. If you want to modify the traffic selector instead of using the default (0.0.0.0/0).</p> <p>Note: This option is only available for the following models:</p> <ul style="list-style-type: none"> • Balance: 30 LTE/Pro, One/Two, 210/310 HW4 or above, 305/380 or above • MediaFast • X series
Local Networks	<p>Enter the local LAN subnets here. If you have defined static routes, they will be shown here.</p> <p>Using NAT, you can map a specific local network / IP address to another, and the packets received by remote gateway will appear to be coming from the mapped network / IP address. This allows you to establish IPsec connection to a remote site that has one or more subnets overlapped with local site.</p> <p>Two types of NAT policies can be defined:</p> <p>One-to-One NAT policy: if the defined subnet in Local Network and NAT Network has the same size, for example, policy "192.168.50.0/24 > 172.16.1.0/24" will translate the local IP address 192.168.50.10 to 172.16.1.10 and 192.168.50.20 to 172.16.1.20. This is a bidirectional mapping which means clients in remote site can initiate connection to the local clients using the mapped address too.</p> <p>Many-to-One NAT policy: if the defined NAT Network on the right hand side is an IP address (or having a network prefix /32), for example, policy "192.168.1.0/24 > 172.168.50.1/32" will translate all clients in 192.168.1.0/24 network to 172.168.50.1. This is a unidirectional mapping which means clients in remote site will not be able to initiate a</p>

	connection to the local clients.
Remote Networks	Enter the LAN and subnets that are located at the remote site here.
Authentication	To access your VPN, clients will need to authenticate by your choice of methods. Choose between the Preshared Key and X.509 Certificate methods of authentication.
Mode	Choose Main Mode if both IPsec peers use static IP addresses. Choose Aggressive Mode if one of the IPsec peers uses dynamic IP addresses.
Force UDP Encapsulation	For forced UDP encapsulation regardless of NAT-traversal, tick this checkbox.
Pre-shared Key	This defines the peer authentication pre-shared key used to authenticate this VPN connection. The connection will be up only if the pre-shared keys on each side match.
Remote Certificate (pem encoded)	Available only when X.509 Certificate is chosen as the Authentication method, this field allows you to paste a valid X.509 certificate.
Local ID	In Main Mode , this field can be left blank. In Aggressive Mode , if Remote Gateway IP Address is filled on this end and the peer end, this field can be left blank. Otherwise, this field is typically a U-FQDN.
Remote ID	In Main Mode , this field can be left blank. In Aggressive Mode , if Remote Gateway IP Address is filled on this end and the peer end, this field can be left blank. Otherwise, this field is typically a U-FQDN.
Phase 1 (IKE) Proposal	In Main Mode , this allows setting up to six encryption standards, in descending order of priority, to be used in initial connection key negotiations. In Aggressive Mode , only one selection is permitted.
Phase 1 DH Group	This is the Diffie-Hellman group used within IKE. This allows two parties to establish a shared secret over an insecure communications channel. The larger the group number, the higher the security. Group 2: 1024-bit is the default value. Group 5: 1536-bit is the alternative option.
Phase 1 SA Lifetime	This setting specifies the lifetime limit of this Phase 1 Security Association. By default, it is set at 3600 seconds.
Phase 2 (ESP) Proposal	In Main Mode , this allows setting up to six encryption standards, in descending order of priority, to be used for the IP data that is being transferred. In Aggressive Mode , only one selection is permitted.
Phase 2 PFS Group	Perfect forward secrecy (PFS) ensures that if a key was compromised, the attacker will be able to access only the data protected by that key. None - Do not request for PFS when initiating connection. However, since there is no valid reason to refuse PFS, the system will allow the connection to use PFS if requested by the remote peer. This is the default value. Group 2: 1024-bit Diffie-Hellman group. The larger the group number, the higher the security.

Group 5: 1536-bit is the third option.	
Phase 2 SA Lifetime	This setting specifies the lifetime limit of this Phase 2 Security Association. By default, it is set at 28800 seconds.

IPsec VPN on the Peplink Balance is specially designed for multi-WAN environments. For instance, if a user sets up multiple IPsec profiles for his multi-WAN environment and WAN1 is connected and healthy, IPsec traffic will go through this link. However, should unforeseen problems (e.g., unplugged cables or ISP problems) cause WAN1 to go down, our IPsec implementation will make use of WAN2 and WAN3 for failover

WAN Connection Priority	
Priority	WAN Selection
1	WAN
2	-----

IPsec Status shows the current connection status of each connection profile and is displayed at **Status > IPsec VPN**.

13.3.3 GRE Tunnel

Generic Routing Encapsulation (GRE) is a tunneling protocol that can encapsulate a wide variety of network layer protocols inside virtual point-to-point links over an Internet Protocol network. A GRE tunnel is similar to IPsec or PepVPN.

To configure a GRE Tunnel, navigate to **Network > VPN > GRE Tunnel**.

GRE Tunnel Profiles	Remote Networks
No GRE profile defined	
New Profile	

Click the **New Profile** button to create new GRE tunnel profiles that establish tunnel connections to remote tunnel endpoints via available WAN connections. To edit the profiles, click on its associated connection name in the leftmost column.

GRE Tunnel Profile ✕

Name	<input style="width: 95%;" type="text"/>		
Active	<input checked="" type="checkbox"/>		
Remote GRE IP Address	<input style="width: 95%;" type="text"/>		
Tunnel Local IP Address	<input style="width: 95%;" type="text"/>		
Tunnel Remote IP Address	<input style="width: 95%;" type="text"/>		
Tunnel Subnet Mask	<input checked="" type="radio"/> Auto <input type="radio"/> 255.255.255.0 (/24) ▼		
Connection	WAN ▼		
Remote Networks	Network	Subnet Mask	
	<input style="width: 95%;" type="text"/>	255.255.255.0 (/24) ▼	<input type="button" value="+"/>

GRE Tunnel Profile Settings	
Name	This field is for specifying a name to represent this GRE Tunnel connection profile.
Active	When this box is checked, this GRE Tunnel connection profile will be enabled. Otherwise, it will be disabled.
Remote GRE IP Address	This field is for entering the remote GRE's IP address
Tunnel Local IP Address	This field is for specifying the tunnel source IP address.
Tunnel Remote IP Address	This field is for specifying the tunnel destination IP address
Tunnel Subnet Mask	This field is to select the subnet mask that is to be used for the GRE tunnel.
Connection	Select the appropriate WAN connection from the drop-down menu.
Remote Networks	Input the LAN and subnets that are located at the remote site here.

13.4 Outbound Policy

Outbound policies for managing and load balancing outbound traffic are located at

Network>Outbound Policy. Click the  button beside the **Outbound Policy** box:

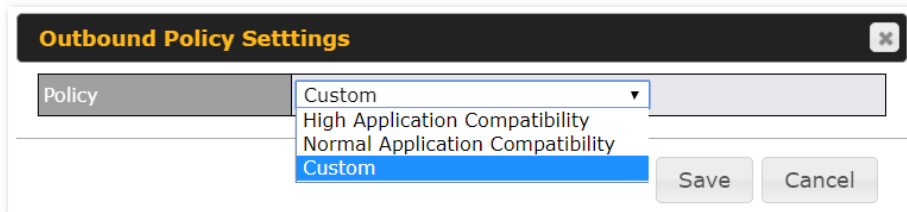
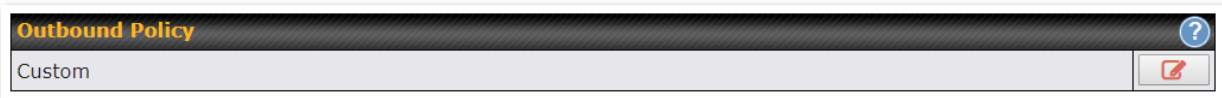

A selection menu will appear, giving you the choice between three different Outbound Policy Settings:

Outbound Policy Settings	
High Application Compatibility	Outbound traffic from a source LAN device is routed through the same WAN connection regardless of the destination Internet IP address and protocol. This option provides the highest application compatibility.
Normal Application Compatibility	Outbound traffic from a source LAN device to the same destination Internet IP address will be routed through the same WAN connection persistently, regardless of protocol. This option provides high compatibility to most applications, and users still benefit from WAN link load balancing when multiple Internet servers are accessed.
Custom	Outbound traffic behavior can be managed by defining rules in a custom rule table. A default rule can be defined for connections that cannot be matched with any of the rules.

The menu underneath enables you to define Outbound policy rules:



The bottom-most rule is **Default**. Edit this rule to change the device's default manner of controlling outbound traffic for all connections that do not match any of the rules above it. Under

the **Service** heading, click **Default** to change these settings.

To rearrange the priority of outbound rules, drag and drop them into the desired sequence.

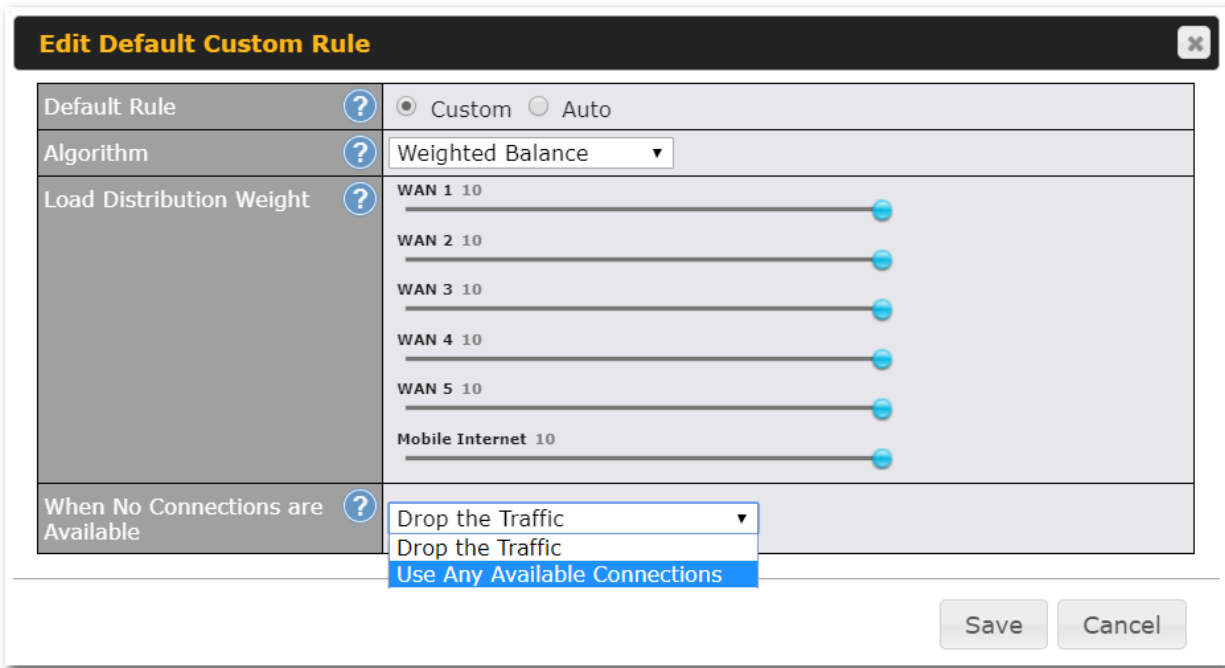

Default Rule	<input checked="" type="radio"/> Custom <input type="radio"/> Auto
Algorithm	Weighted Balance
Load Distribution Weight	WAN 1 10
	WAN 2 10
	WAN 3 10
	WAN 4 10
	WAN 5 10
	Mobile Internet 10
When No Connections are Available	Drop the Traffic Drop the Traffic Use Any Available Connections

By default, **Auto** is selected as the **Default Rule**. You can select **Custom** to change the algorithm to be used. Please refer to the upcoming sections for the details on the available algorithms.

To create a custom rule, click **Add Rule** at the bottom of the table.

Add a New Custom Rule
✕

Service Name	<input style="width: 90%;" type="text"/>
Enable	<input checked="" type="checkbox"/> Always on ▾
Source	Any ▾
Destination	<input type="text" value="IP Network"/> ▾ <input style="width: 100px;" type="text"/> Mask: <input type="text" value="255.255.255.0 (/24)"/> ▾
Protocol	Any ▾ ← :: Protocol Selection :: ▾
Algorithm	Weighted Balance ▾
Load Distribution Weight	<div style="display: flex; flex-direction: column; gap: 5px;"> <div>WAN 1 10 <input style="width: 100px;" type="range"/></div> <div>WAN 2 10 <input style="width: 100px;" type="range"/></div> <div>WAN 3 10 <input style="width: 100px;" type="range"/></div> <div>WAN 4 10 <input style="width: 100px;" type="range"/></div> <div>WAN 5 10 <input style="width: 100px;" type="range"/></div> <div>Mobile Internet 10 <input style="width: 100px;" type="range"/></div> </div>
When No Connections are Available	Drop the Traffic ▾

New Custom Rule Settings																									
Service Name	This setting specifies the name of the outbound traffic rule.																								
Enable	<p>This setting specifies whether the outbound traffic rule takes effect. When Enable is checked, the rule takes effect: traffic is matched and actions are taken by the Pepwave router based on the other parameters of the rule. When Enable is unchecked, the rule does not take effect: the Pepwave router disregards the other parameters of the rule.</p> <p>Click the drop-down menu next to the checkbox to apply a time schedule to this custom rule.</p>																								
Source	<p>This setting specifies the source IP address, IP network, MAC address or Grouped network for traffic that matches the rule.</p> <div style="border: 1px solid gray; padding: 5px; width: fit-content;"> <table border="1" style="width: 100%; border-collapse: collapse;"> <tr><td style="width: 30%;">Source</td><td style="width: 10%; text-align: center;">?</td><td style="width: 10%;"><input type="text" value="Any"/></td><td style="width: 5%; text-align: center;">▾</td></tr> <tr><td>Destination</td><td style="text-align: center;">?</td><td style="background-color: #007bff; color: white;">Any</td><td></td></tr> <tr><td></td><td></td><td>IP Address</td><td></td></tr> <tr><td></td><td></td><td>IP Network</td><td></td></tr> <tr><td></td><td></td><td>MAC Address</td><td></td></tr> <tr><td></td><td></td><td>Grouped Network</td><td></td></tr> </table> </div>	Source	?	<input type="text" value="Any"/>	▾	Destination	?	Any				IP Address				IP Network				MAC Address				Grouped Network	
Source	?	<input type="text" value="Any"/>	▾																						
Destination	?	Any																							
		IP Address																							
		IP Network																							
		MAC Address																							
		Grouped Network																							
Destination	This setting specifies the destination IP address, IP network, Domain name, SpeedFusion Cloud, PepVPN Profile or Grouped network for traffic that matches the rule.																								

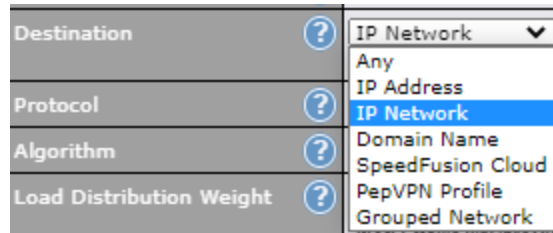

If **Domain Name** is chosen and a domain name, such as *foobar.com*, is entered, any outgoing accesses to *foobar.com* and **.foobar.com* will match this criterion. You may enter a wildcard (.*) at the end of a domain name to match any host with a name having the domain name in the middle. If you enter *foobar.**, for example, *www.foobar.com*, *www.foobar.co.jp*, or *foobar.co.uk* will also match. Placing wildcards in any other position is not supported.

NOTE: if a server has one Internet IP address and multiple server names, and if one of the names is defined here, access to any one of the server names will also match this rule.

Protocol and Port

This setting specifies the IP protocol and port of traffic that matches this rule. Via a drop-down menu, the following protocols can be specified:

- Any
- TCP
- UDP
- IP
- DSCP

Alternatively, the **Protocol Selection Tool** drop-down menu can be used to automatically fill in the protocol and port number of common Internet services (e.g., HTTP, HTTPS, etc.) After selecting an item from the **Protocol Selection Tool** drop-down menu, the protocol and port number remains manually modifiable.

Algorithm

This setting specifies the behavior of the Pepwave router for the custom rule. One of the following values can be selected (note that some Pepwave routers provide only some of these options):

- Weighted Balance
- Persistence
- Enforced
- Priority
- Overflow
- Least Used
- Lowest Latency
- Fastest Response Time

For a full explanation of each Algorithm, please see the following article:

<https://forum.peplink.com/t/exactly-how-do-peplinks-load-balancing-algorithmns-work/8059>

Load Distribution Weight

This is to define the outbound traffic weight ratio for each WAN connection.

<p>When No connections are available</p>	<p>This field allows you to configure the default action when all the selected Connections are not available.</p> <p>Drop the Traffic - Traffic will be discarded.</p> <p>Use Any Available Connections - Traffic will be routed to any available Connection, even it is not selected in the list.</p> <p>Fall-through to Next Rule - Traffic will continue to match next Outbound Policy rule just like this rule is inactive.</p>
<p>Terminate Sessions on Link Recovery</p>	<p>This setting specifies whether to terminate existing IP sessions on a less preferred WAN connection in the event that a more preferred WAN connection is recovered. This setting is applicable to the Priority algorithms. By default, this setting is disabled. In this case, existing IP sessions will not be terminated or affected when any other WAN connection is recovered. When this setting is enabled, existing IP sessions may be terminated when another WAN connection is recovered, such that only the preferred healthy WAN connection(s) is used at any point in time.</p>

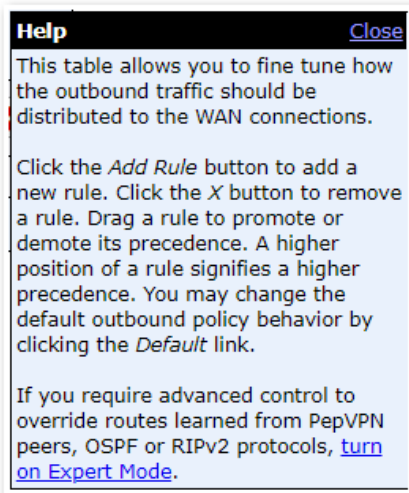

Expert Mode is available on some Pepwave routers for use by advanced users. To enable the feature, click on the help icon and click **turn on Expert Mode**.

In Expert Mode, a new special rule, **SpeedFusion™ Routes**, is displayed in the **Custom Rules** table. This rule represents all SpeedFusion™ routes learned from remote VPN peers. By default, this bar is on the top of all custom rules. This position means that traffic for remote VPN subnets will be routed to the corresponding VPN peer. You can create custom **Priority** or **Enforced** rules and move them

above the bar to override the SpeedFusion™ routes.

Upon disabling Expert Mode, all rules above the bar will be removed.

Algorithm: Weighted Balance

This setting specifies the ratio of WAN connection usage to be applied on the specified IP protocol and port. This setting is applicable only when **Algorithm** is set to **Weighted Balance**.

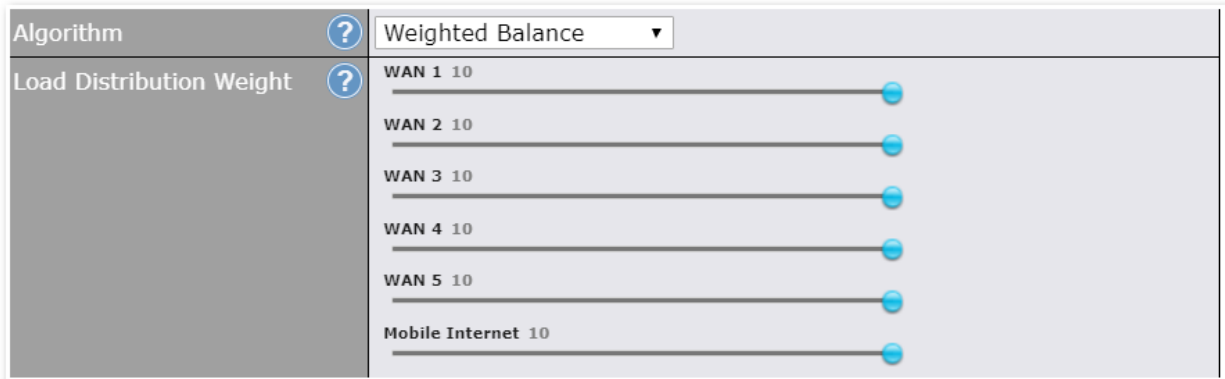

The amount of matching traffic that is distributed to a WAN connection is proportional to the weight of the WAN connection relative to the total weight. Use the sliders to change each WAN's weight.

For example, with the following weight settings:

- Ethernet WAN1: 10
- Ethernet WAN2: 10
- Wi-Fi WAN: 10
- Cellular 1: 10
- Cellular 2: 10
- USB: 10

Total weight is 60 = (10 +10 + 10 + 10 + 10 + 10).

Matching traffic distributed to Ethernet WAN1 is 16.7% = (10 / 60 x 100%).

Matching traffic distributed to Ethernet WAN2 is 16.7% = (10 / 60) x 100%.

Matching traffic distributed to Wi-Fi WAN is 16.7% = (10 / 60) x 100%.

Matching traffic distributed to Cellular 1 is 16.7% = (10 / 60) x 100%.

Matching traffic distributed to Cellular 2 is 16.7% = (10 / 60) x 100%.

Matching traffic distributed to USB is 16.7% = (10 / 60) x 100%.



Algorithm: Persistence

The configuration of persistent services is the solution to the few situations where link load distribution for Internet services is undesirable. For example, for security reasons, many e-banking and other secure websites terminate the session when the client computer's Internet IP address changes mid-session.

In general, different Internet IP addresses represent different computers. The security concern is that an IP address change during a session may be the result of an unauthorized intrusion attempt. Therefore, to prevent damages from the potential intrusion, the session is terminated upon the detection of an IP address change.

Pepwave routers can be configured to distribute data traffic across multiple WAN connections. Also, the Internet IP depends on the WAN connections over which communication actually takes place. As a result, a LAN client computer behind the Pepwave router may communicate using multiple Internet IP addresses. For example, a LAN client computer behind a Pepwave router with three WAN connections may communicate on the Internet using three different IP addresses.

With the persistence feature, rules can be configured to enable client computers to persistently utilize the same WAN connections for e-banking and other secure websites. As a result, a client computer will communicate using one IP address, eliminating the issues mentioned above.

Algorithm	 Persistence
Persistence Mode	 <input checked="" type="radio"/> By Source <input type="radio"/> By Destination

There are two persistent modes: **By Source** and **By Destination**.

By Source:	The same WAN connection will be used for traffic matching the rule and originating from the same machine, regardless of its destination. This option will provide the highest level of application compatibility.
By Destination:	The same WAN connection will be used for traffic matching the rule, originating from the same machine, and going to the same destination. This option can better distribute loads to WAN connections when there are only a few client machines.

The default mode is **By Source**. When there are multiple client requests, they can be distributed (persistently) to WAN connections with a weight. If you choose **Auto** in **Load Distribution**, the weights will be automatically adjusted according to each WAN's **Downstream Bandwidth** which is specified in the WAN settings page). If you choose **Custom**, you can customize the weight of each WAN manually by using the sliders.

Algorithm: Enforced

This setting specifies the WAN connection usage to be applied on the specified IP protocol and port. This setting is applicable only when **Algorithm** is set to **Enforced**.

Algorithm	? Enforced
Enforced Connection	? <ul style="list-style-type: none"> WAN: WAN 1 <li style="background-color: #007bff; color: white;">WAN: WAN 1 WAN: WAN 2 WAN: WAN 3 WAN: WAN 4 WAN: WAN 5 WAN: Mobile Internet
<input type="button" value="Save"/> <input type="button" value="Cancel"/>	

Matching traffic will be routed through the specified WAN connection, regardless of the health check status of the WAN connection. Outbound traffic can also be enforced to go through a specified SpeedFusion™ connection.

Algorithm: Priority

This setting specifies the priority of the WAN connections used to route the specified network service. The highest priority WAN connection available will always be used for routing the specified type of traffic. A lower priority WAN connection will be used only when all higher priority connections have become unavailable.

Priority Order	?	Highest Priority	Not In Use
		WAN: WAN	
		WAN: Cellular 1	
		WAN: Cellular 2	
		WAN: USB	
		WAN: LAN 1 as WAN	
		WAN: GRE WAN 1	
		WAN: GRE WAN 2	
		WAN: OpenVPN WAN 1	
		Lowest Priority	
When No Connections are Available	?	Drop the Traffic	
Terminate Sessions on Connection Recovery	?	<input type="checkbox"/> Enable	

Starting from Firmware 5.2, outbound traffic can be prioritized to go through SpeedFusion™ connection(s). By default, VPN connections are not included in the priority list.

Tip

Configure multiple distribution rules to accommodate different kinds of services.

Algorithm: Overflow

The traffic matching this rule will be routed through the healthy WAN connection that has the highest priority and is not in full load. When this connection gets saturated, new sessions will be routed to the next healthy WAN connection that is not in full load.

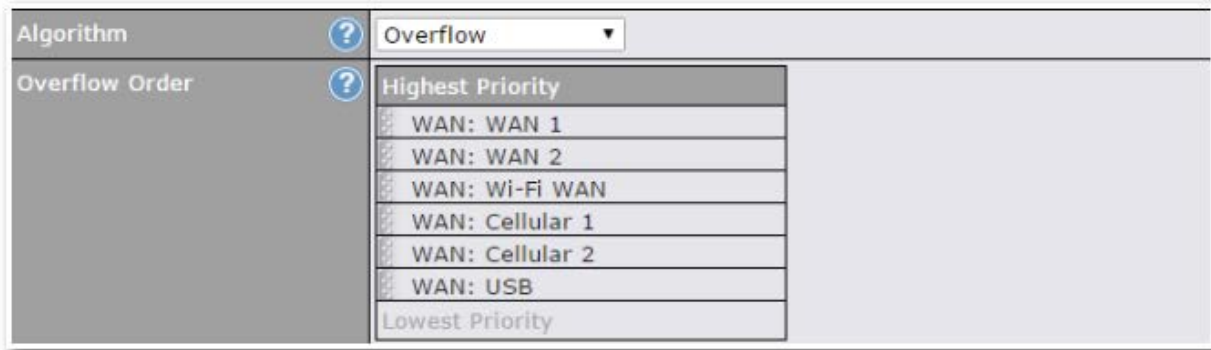

Drag and drop to specify the order of WAN connections to be used for routing traffic. Only the highest priority healthy connection that is not in full load will be used.

Algorithm: Least Used

Add a New Custom Rule
✕

Service Name	<input type="text"/>
Enable	<input checked="" type="checkbox"/> Always on ▾
Source	Any ▾
Destination ?	IP Network ▾ <input type="text"/> Mask: 255.255.255.0 (/24) ▾
Protocol ?	Any ▾ ◀ :: Protocol Selection :: ▾
Algorithm ?	Least Used ▾
Connection	<input type="checkbox"/> WAN 1 <input checked="" type="checkbox"/> WAN 2 <input checked="" type="checkbox"/> WAN 3 <input type="checkbox"/> WAN 4 <input type="checkbox"/> WAN 5
When No Connections are Available ?	Drop the Traffic ▾

The traffic matching this rule will be routed through the healthy WAN connection that is selected in **Connection** and has the most available download bandwidth. The available download bandwidth of a WAN connection is calculated from the total download bandwidth specified on the WAN settings page and the current download usage. The available bandwidth and WAN selection is determined every time an IP session is made.

Algorithm: Lowest Latency

Add a New Custom Rule
✕

Service Name	<input type="text"/>
Enable	<input checked="" type="checkbox"/> Always on ▾
Source	Any ▾
Destination	<input type="text" value="IP Network"/> ▾ <input type="text" value="Mask: 255.255.255.0 (/24)"/> ▾
Protocol	<input type="text" value="Any"/> ▾ < ⌂ :: Protocol Selection :: ▾
Algorithm	<input type="text" value="Lowest Latency"/> ▾ <small>Note: Use of Lowest Latency will incur additional network usage.</small>
Connection	<input type="checkbox"/> WAN 1 <input checked="" type="checkbox"/> WAN 2 <input checked="" type="checkbox"/> WAN 3 <input type="checkbox"/> WAN 4 <input type="checkbox"/> WAN 5 <input type="checkbox"/> Mobile Internet
When No Connections are Available	<input type="text" value="Drop the Traffic"/> ▾

The traffic matching this rule will be routed through the healthy WAN connection that is selected in **Connection** and has the lowest latency. Latency checking packets are issued periodically to a nearby router of each WAN connection to determine its latency value. The latency of a WAN is the packet round trip time of the WAN connection. Additional network usage may be incurred as a result.

Tip

The roundtrip time of a 6M down/640k uplink can be higher than that of a 2M down/2M up link because the overall round trip time is lengthened by its slower upload bandwidth, despite its higher downlink speed. Therefore, this algorithm is good for two scenarios:

- All WAN connections are symmetric; or
- A latency sensitive application must be routed through the lowest latency WAN, regardless of the WAN's available bandwidth.

Algorithm : Fastest Response Time

Add a New Custom Rule
✕

Service Name	<input type="text"/>
Enable	<input checked="" type="checkbox"/> Always on ▾
Source	Any ▾
Destination	? IP Network ▾ <input type="text"/> Mask: 255.255.255.0 (/24) ▾
Protocol	? Any ▾ ← :: Protocol Selection :: ▾
Algorithm	? Fastest Response Time ▾
Connection	<input checked="" type="checkbox"/> WAN 1 <input checked="" type="checkbox"/> WAN 2 <input type="checkbox"/> WAN 3 <input type="checkbox"/> WAN 4 <input type="checkbox"/> WAN 5 <input type="checkbox"/> Mobile Internet
When No Connections are Available	? <input type="text" value="Drop the Traffic"/> ▾

The Fastest response Time algorithm works as follows:

When a network session is created, the first outgoing packet of that particular session is duplicated to all the available WANs.

When the first response is received from a remote server, any further traffic for this session will be routed over that particular WAN connection for the fastest possible response time.

If any slower responses are received on other connections afterwards, they will be discarded.

13.5 Inbound Access

Inbound access is also known as inbound port address translation. On a NAT WAN connection, all inbound traffic to the server behind the Peplink unit requires inbound access rules.

By the custom definition of servers and services for inbound access, Internet users can access the servers behind Peplink Balance. Advanced configurations allow inbound access to be distributed among multiple servers on the LAN.

Important Note

Inbound access applies only to WAN connections that operate in NAT mode. For WAN connections that operate in drop-in mode or IP forwarding, inbound traffic is forwarded to the LAN by default.

13.5.1 Servers

The settings to configure servers on the LAN are located at **Network>Inbound Access>Servers**.

Inbound connections from the Internet will be forwarded to the specified Inbound IP address(es) based on the protocol and port number. When more than one server is defined, requests will be distributed to the servers in the weight ratio specified for each server.

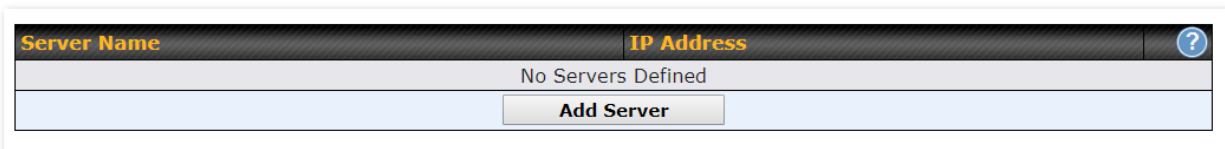

Server Name	IP Address
No Servers Defined	
<input type="button" value="Add Server"/>	

To define a new server, click **Add Server**, which displays the following screen:

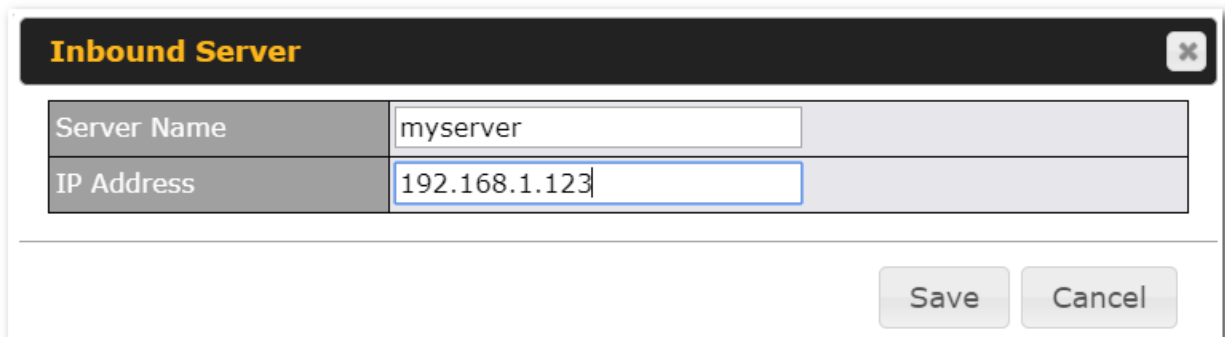

Inbound Server

Server Name	<input type="text" value="myserver"/>
IP Address	<input type="text" value="192.168.1.123"/>

Enter a valid server name and its corresponding LAN IP address. Upon clicking **Save** after entering required information, the following screen appears.

Server Name	IP Address	
myserver	192.168.1.123	<input type="checkbox"/>
Add Server		

To define additional servers, click **Add Server** and repeat the above steps.

13.5.2 Services

Services are defined at **Network>Inbound Access>Services**.

Service	IP Address(es)	Server	Protocol
No Services Defined			
Add Service			

Tip

At least one server must be defined before services can be added.

To define a new service, click the **Add Service** button, upon which the following menu appears:

Inbound Service ✕

Enable	<input checked="" type="checkbox"/>
Service Name	<input type="text"/>
Protocol	TCP ← :: Protocol Selection ::
Port	Any Port
Inbound IP Address(es) <small>(Require at least one IP address)</small>	<div style="border: 1px solid #ccc; padding: 5px;"> <div style="background-color: #333; color: white; padding: 2px;">Connection / IP Address(es)</div> <div style="text-align: right; padding: 2px;">All Clear</div> <ul style="list-style-type: none"> <input type="checkbox"/> WAN 1 <input type="checkbox"/> WAN 2 <input type="checkbox"/> WAN 3 <input type="checkbox"/> WAN 4 <input type="checkbox"/> WAN 5 <input type="checkbox"/> Mobile Internet <input type="checkbox"/> PepVPN </div>
Included Server(s) <small>(Require at least one IP address)</small>	<div style="border: 1px solid #ccc; padding: 5px;"> <div style="background-color: #333; color: white; padding: 2px;">Server</div> <ul style="list-style-type: none"> <input type="checkbox"/> myserver (192.168.1.123) </div>

Services Settings	
Enable	<p>This setting specifies whether the inbound service rule takes effect.</p> <p>When Yes is selected, the inbound service rule takes effect. If the inbound traffic matches the specified IP protocol and port, action will be taken by the Peplink Balance based on the other parameters of the rule.</p> <p>When No is selected, the inbound service rule does not take effect. The Peplink Balance will disregard the other parameters of the rule.</p>
Service Name	<p>This setting identifies the service to the system administrator. Only alphanumeric and the underscore “_” characters are valid.</p>
IP Protocol	<p>The IP Protocol setting, along with the Port setting, specifies the protocol of the service as TCP, UDP, ICMP, or IP. Inbound traffic that matches the specified IP Protocol and Port(s) will be forwarded to the LAN hosts specified by the Servers setting.</p> <p>Upon choosing a protocol, the Protocol Selection Tool drop-down menu can be used to automatically the port information of common Internet services (e.g. HTTP, HTTPS, etc.).</p> <p>After selecting an item from the Protocol Selection Tool drop-down menu, the protocol and the port number will remain manually modifiable.</p>
Port	<p>The Port setting specifies the port(s) that correspond to the service, and can be configured to behave in one of the following manners:</p> <p>Any Port, Single Port, Port Range, Port Map, and Range Mapping</p> <div style="border: 1px solid #ccc; padding: 5px; margin-bottom: 10px;"> <p>Port Any Port</p> </div> <p>Any Port: all traffic that is received by the Peplink Balance via the specified protocol is forwarded to the servers specified by the Servers setting.</p> <p>For example, if IP Protocol is set to TCP and Port is set to Any Port, then all TCP traffic will be forwarded to the configured servers.</p> <div style="border: 1px solid #ccc; padding: 5px; margin-bottom: 10px;"> <p>Port Single Port Service Port: 80</p> </div> <p>Single Port: traffic that is received by the Peplink Balance via the specified protocol at the specified port is forwarded via the same port to the servers specified by the Servers setting.</p> <p>For example, if IP Protocol is set to TCP, Port is set to Single Port, and Service Port is set to 80, then TCP traffic received on Port 80 will be forwarded to the configured servers via port 80.</p> <div style="border: 1px solid #ccc; padding: 5px; margin-bottom: 10px;"> <p>Port Port Range Service Ports: 80 - 88</p> </div> <p>Port Range: traffic that is received by the Peplink Balance via the specified protocol at the specified port range is forwarded via the same respective ports to the LAN hosts specified by the Servers setting.</p> <p>For example, if IP Protocol is set to TCP, Port is set to Port Range, and Service Port set to 80-88, then TCP traffic received on ports 80 through 88 will be forwarded to the configured servers via the respective ports.</p> <div style="border: 1px solid #ccc; padding: 5px; margin-bottom: 10px;"> <p>Port Port Mapping Service Port: 80 Map to Port: 88</p> </div> <p>Port Mapping: traffic that is received by the Peplink Balance via the specified protocol at the specified port is forwarded via a different port to the servers specified by the Servers setting.</p> <p>For example, if IP Protocol is set to TCP, Port is set to Port Mapping, Service Port is set to 80, and Map to Port is set to 88, then TCP traffic on port 80 is forwarded to the configured servers via port 88.</p> <p>(Please see below for details on the Servers setting.)</p>

	<p>Range Mapping: traffic that is received by Peplink Balance via the specified protocol at the specified port range is forwarded via a different port to the servers specified by the Servers setting.</p>
<p>Inbound IP Address(es)</p>	<p>This setting specifies the WAN connections and Internet IP address(es) from which the service can be accessed.</p>
<p>Included Server(s)</p>	<p>This setting specifies the LAN servers that handle requests for the service, and the relative weight values. The amount of traffic that is distributed to a server is proportional to the weight value assigned to the server relative to the total weight.</p> <p>Example:</p> <p>With the following weight settings on a Peplink Balance:</p> <ul style="list-style-type: none"> • demo_server_1: 10 • demo_server_2: 5 <p>The total weight is 15 = (10 + 5)</p> <p>Matching traffic distributed to demo_server_1: 67% = (10 / 15) x 100%</p> <p>Matching traffic distributed to demo_server_2: 33% = (5 / 15) x 100%</p>

UPnP / NAT-PMP Settings

UPnP and NAT-PMP are network protocols which allow a computer connected to the LAN port to automatically configure the router to allow parties on the WAN port to connect to itself. That way, the process of inbound port forwarding becomes automated.

When a computer creates a rule using these protocols, the specified TCP/UDP port of all WAN connections' default IP address will be forwarded.

Check the corresponding box(es) to enable UPnP and/or NAT-PMP. Enable these features only if you trust the computers connected to the LAN ports.

UPnP / NAT-PMP Settings	
UPnP	<input type="checkbox"/> Enable
NAT-PMP	<input type="checkbox"/> Enable
<input type="button" value="Save"/>	

When the options are enabled, a table listing all the forwarded ports under these two protocols can be found at **Network > Services > UPnP / NAT-PMP**.

13.5.3 DNS Settings

The built-in DNS server functionality of the Peplink Balance facilitates inbound load balancing. With this functionality, NS/SOA DNS records for a domain name can be delegated to the Internet IP address(es) of the Peplink Balance. Upon receiving a DNS query, the Peplink Balance can return (as an “A” record) the IP address for the domain name on the most appropriate healthy WAN connection. It can also act as a generic DNS server for hosting “A”, “CNAME”, “MX”, “TXT” and “NS” records.

The settings for defining the DNS records to be hosted by the Peplink Balance are located at **Network > Inbound Access > DNS Settings**.

Note: DNS names may only contain alphanumeric characters (A-Z and 0-9), hyphens (-), and periods (.). The period is only allowed when it is used to delimit the components of domain style names.

For more information, see the following websites:

- rfc952
- rfc1123

DNS Server	Disabled							
Zone Transfer	Disabled							
Default SOA / NS	Undefined							
Default Connection Priority	Priority 1: WAN 1, WAN 2, WAN 3, WAN 4, WAN 5, Mobile Internet							
Domain Names	<table border="1"> <tr> <td>Domain Name</td> <td></td> </tr> <tr> <td colspan="2" style="text-align: center;"><i>There is currently no DNS domains.</i></td> </tr> <tr> <td colspan="2" style="text-align: center;"><input type="button" value="New Domain Name"/></td> </tr> </table>		Domain Name		<i>There is currently no DNS domains.</i>		<input type="button" value="New Domain Name"/>	
Domain Name								
<i>There is currently no DNS domains.</i>								
<input type="button" value="New Domain Name"/>								
Reverse Lookup Zones	<table border="1"> <tr> <td>Zone Name</td> <td></td> </tr> <tr> <td colspan="2" style="text-align: center;"><i>There is currently no Reverse Lookup Zones.</i></td> </tr> <tr> <td colspan="2" style="text-align: center;"><input type="button" value="New Reverse Lookup Zone"/></td> </tr> </table>		Zone Name		<i>There is currently no Reverse Lookup Zones.</i>		<input type="button" value="New Reverse Lookup Zone"/>	
Zone Name								
<i>There is currently no Reverse Lookup Zones.</i>								
<input type="button" value="New Reverse Lookup Zone"/>								

[Import records via zone transfer...](#)

DNS Settings	
DNS Servers	<p>This setting specifies the WAN IP addresses on which the DNS server of the Peplink Balance should listen.</p> <p>If no addresses are selected, the inbound link load balancing feature will be disabled and the Peplink Balance will not respond to DNS requests.</p>

	<p>To specify and/or modify the IP addresses on which the DNS server should listen, click the button that corresponds to DNS Server, and a selection screen will be displayed:</p> <p>To specify the Internet IP addresses on which the DNS server should listen, select the desired WAN connection then select the desired associated IP addresses. (Multiple items in the list can be selected by holding CTRL and clicking on the items.)</p> <p>Click Save to save the settings when configuration is complete.</p>
Zone Transfer	<p>This setting specifies the IP address(es) of the secondary DNS server(s) authorized to retrieve zone records from the DNS server of the Peplink Balance.</p> <p>The zone transfer server of the Peplink Balance listens on TCP port 53.</p> <p>The Peplink Balance serves both the clients that are accessing from the specified IP addresses, and the clients that are accessing its LAN interface.</p>
Routing Control by Subnet Database	<p>When this function is enabled, the system will check to see if an incoming DNS client is within any WAN's ISP subnet. Only the matched WAN(s)'s IP addresses will be returned. Note that this feature is available only when a subnet database has been defined.</p>
Default SOA / NS	<p>Click the button to define a default SOA / NS record for all domain names.</p> <p>When defining a default SOA record, Name Server IP Address is optional. If left blank, the Address (A) record for the same server should be defined manually in each domain.</p> <p>For defining default NS records, the host <i>[domain]</i> indicates that this record is for the domain name itself without a sub-domain prefix. To add a secondary NS server, just create a second NS record with the Host field left empty. When the entered name server is a fully qualified domain name (FQDN), the IP Address field will be disabled.</p>
Default Connection Priority	<p>Default Connection Priority defines the default priority group of each WAN connection in resolving A records. It applies to Address (A) records which have the Connection Priority set to Default. Please refer to Section 17.3.9 for details.</p> <p>The WAN connection(s) with the highest priority (smallest number) will be chosen. Those with lower priorities will not be chosen in resolving A records unless the higher priority ones become unavailable.</p> <p>To specify the primary and backup connections, click the button that corresponds to Default Connection Priority. A selection screen will appear.</p> <p>Each WAN connection is associated with a priority number. Click Save to save the settings when configuration is complete.</p>
Domain name	<p>This section shows a list of domain names to be hosted by the Peplink Balance. Each domain can have its "NS", "MX" and "TXT" records, and its sub-domains' "A" and "CNAME" records. Add a new record by clicking the New Domain Name button. Click on a domain name to edit. Press the red X to remove a domain name.</p>

New Domain Name

Upon clicking the New Domain Name button, and the following screen will appear:

SOA Record ?						
Use Default SOA and NS Records						

NS Records ?			
Host	Name Server	TTL (sec)	
<i>There is currently no NS records.</i>			
<input type="button" value="New NS Records"/>			

MX Records ?			
Host	Priority	Mail Server	TTL (sec)
<i>There is currently no MX records.</i>			
<input type="button" value="New MX Records"/>			

CNAME Records ?		
Host	Points To	TTL (sec)
<i>There is currently no CNAME records.</i>		
<input type="button" value="New CNAME Record"/>		

A Records ?		
Host	Included IP Address(es)	TTL (sec)
<i>There is currently no A records.</i>		
<input type="button" value="New A Record"/>		

TXT Records ?		
Host	TXT Value	TTL (sec)
<i>There is currently no default TXT records.</i>		
<input type="button" value="New TXT Record"/>		

SRV Records ?					
Service	Priority	Weight	Target	Port	TTL (sec)
<i>There is currently no SRV records</i>					
<input type="button" value="New SRV Record"/>					

This page is for defining the domain's SOA, NS, MX, CNAME, A, TXT, and SRV records. Seven tables are presented in this page for defining the five types of records.

SOA Records

Default / Custom SOA Record
✕

Policy	<input checked="" type="radio"/> Use Default SOA and NS Records <input type="radio"/> Customize SOA Record for this domain
--------	---

Click on the icon to choose whether to use the pre-defined default SOA record and NS records. If the option **Use Default SOA and NS Records** is selected, any changes made in the default SOA/NS records will be applied to this domain automatically. Otherwise, select the option **Customize SOA Record** for this domain to customize this domain's SOA and NS records.

SOA Record
✕

Name Server	?	<input type="text" value="ns1"/>
Name Server IP Address	?	<input type="text"/>
Email	?	<input type="text" value="webmaster"/>
Refresh (sec)	?	<input type="text" value="14400"/>
Retry (sec)	?	<input type="text" value="900"/>
Expire (sec)	?	<input type="text" value="1209600"/>
Min Time (sec)	?	<input type="text" value="3600"/>
TTL (sec)	?	<input type="text" value="3600"/>

This table displays the current SOA record. When the option **Customize SOA Record for this domain** is selected, you can click the link **Click here to define SOA record** to create or click on the **Name Server** field to edit the SOA record.

In the SOA record, you have to fill out the fields **Name Server**, **Name Server IP Address**, **Email**, **Refresh**, **Retry**, **Expire**, **Min Time**, and **TTL**.

Default values are set for SOA and NS records,

- **Name Server IP Address:** This is the IP address of the authoritative name server. An

entry in this field is optional. If the Balance is the authoritative name server of the domain, this field's value should be the WAN connection's name server IP address that is registered in the DNS registrar. If this field is entered, a corresponding A record for the name server will be created automatically. If it is left blank, the A record for the name server must be created manually.

- **E-mail:** Defines the e-mail address of the person responsible for this zone. Note: format should be *mailbox-name.domain.com*, e.g., *hostmaster.example.com*.
- **Refresh:** Indicates the length of time (in seconds) when the slave will try to refresh the zone from the master.
- **Retry:** Defines the duration (in seconds) between retries if the slave (secondary) fails to contact the master and the refresh (above) has expired.
- **Expire:** Indicates the time (in seconds) when the zone data is no longer authoritative. This option applies to slave DNS servers only.
- **Min Time:** Is the negative caching time which defines the time (in seconds) after an error record is cached.
- **TTL (Time-to-Live):** Defines the duration (in seconds) that the record may be cached.

NS Records

The **NS Records** table shows the NS servers and TTL that correspond to the domain. The NS record of the name server defined in the SOA record is automatically added here.

To add a new NS record, click the **New NS Records** button in the **NS Records** box. Then the table will expand to look like the following:

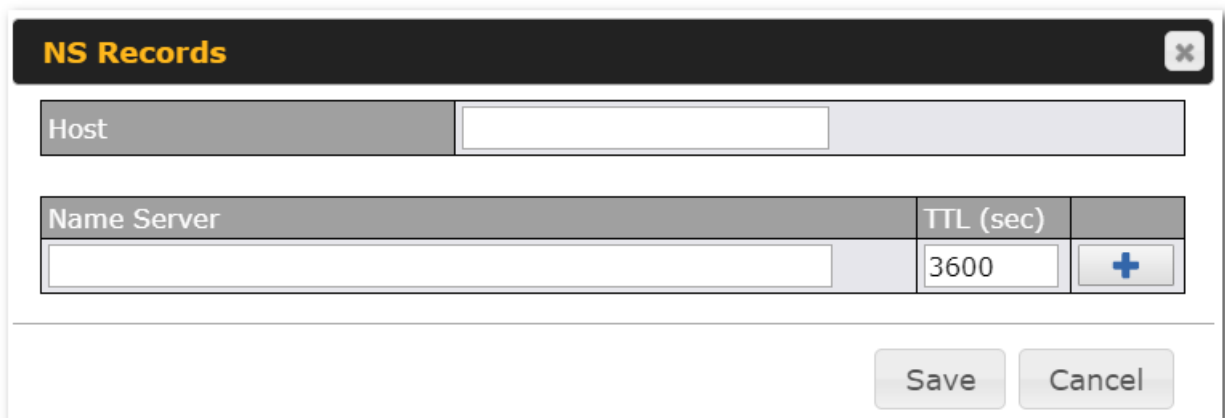

NS Records		
Host	<input type="text"/>	
Name Server	TTL (sec)	
<input type="text"/>	3600	<input type="button" value="+"/>
		<input type="button" value="Save"/> <input type="button" value="Cancel"/>

When creating an NS record for the domain itself (not a sub-domain), the **Host** field should be left blank.

Enter a name server host name and its IP address into the corresponding boxes. The host name can be a non-FQDN (fully qualified domain name). Please be sure that a corresponding A record is created. Click the button on the right to finish and to add other name servers. Click the **Save** button to save your changes.

MX Records

The **MX Record** table shows the domain's MX records. To add a new MX record, click the **New MX Records** button in the **MX Records** box. Then the table will expand to look like the following:

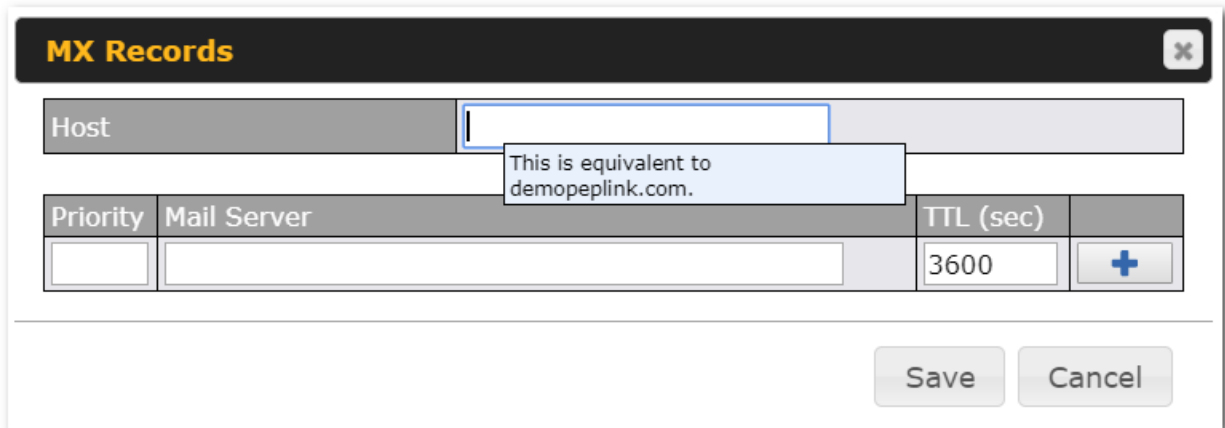

Host	Priority	Mail Server	TTL (sec)	
			3600	+

Save Cancel

When creating an MX record for the domain itself (not a sub-domain), the **Host** field should be left blank.

For each record, **Priority and Mail Server** name must be entered. **Priority** typically ranges from 10 to 100. Smaller numbers have a higher priority. After finishing adding MX records, click the **Save** button.

CNAME Records

The **CNAME Record** table shows the domain's CNAME records. To add a new CNAME record, click the **New CNAME Records** button in the **CNAME Record** box. Then the table will expand to look like the following:

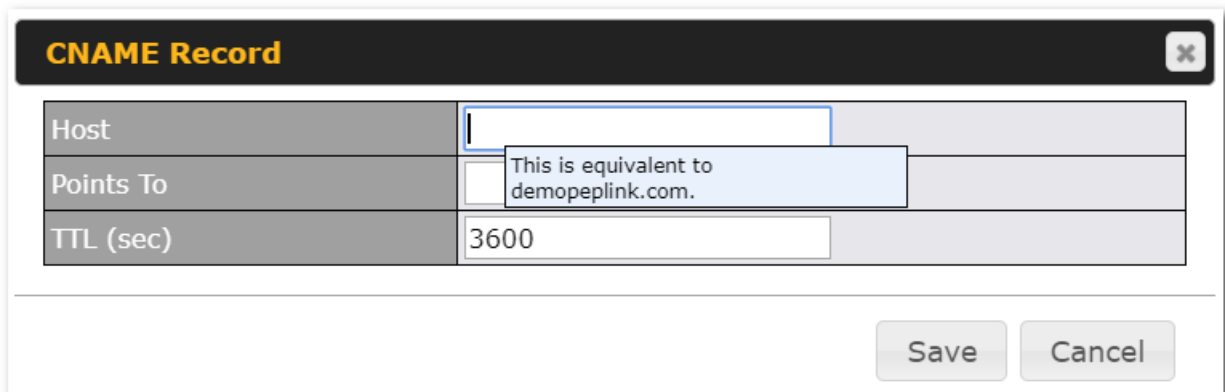

Host	Points To	TTL (sec)
		3600

Save Cancel

When creating a CNAME record for the domain itself (not a sub-domain), the **Host** field should be left blank.

The wildcard character "*" is supported in the **Host** field. The reference of ".domain.name" will be returned for every name ending with ".domain.name" except names that have their own records.

The **TTL** field tells the time to live of the record in external DNS caches.

A Records

This table shows the A records of the domain name. To add an A record, click the **New A Record** button. The following screen will appear:

A Record
✕

Host	<input style="width: 90%;" type="text"/>
TTL (sec)	<input style="width: 20px;" type="text" value="5"/> <div style="border: 1px solid #ccc; padding: 2px; font-size: 0.8em; margin-left: 5px;">This is equivalent to demopeplink.com.</div>
Priority	<input checked="" type="radio"/> Default <input type="radio"/> Custom

Included IP Address(es)
<input type="checkbox"/> WAN 1
<input type="checkbox"/> WAN 2
<input type="checkbox"/> WAN 3
<input type="checkbox"/> WAN 4
<input type="checkbox"/> WAN 5
<input type="checkbox"/> Mobile Internet
<input type="checkbox"/> Custom IP Address

A record may be automatically added for the SOA records with a name server IP address provided.

A Record	
Host Name	This field specifies the A record of this sub-domain to be served by the Peplink Balance. The wildcard character "*" is supported. The IP addresses of "*.domain.name" will be returned for every name ending with ".domain.name" except names that have their own records.
TTL	This setting specifies the time to live of this record in external DNS caches. In order to reflect any dynamic changes on the IP addresses in case of link failure and recovery, this value should be set to a smaller value, e.g., 5 secs, 60 secs, etc.
Priority	This option specifies the priority of different connections. Select the Default option to apply the Default Connection Priority (refer to the table

	<p>shown on the main DNS settings page) to an A record. To customize priorities, choose the Custom option and a priority selection table will be shown at the bottom.</p>
<p>Included IP Address(es)</p>	<p>This setting specifies lists of WAN-specific Internet IP addresses that are candidates to be returned when the Peplink Balance responds to DNS queries for the domain name specified by Host Name.</p> <p>The IP addresses listed in each box as default are the Internet IP addresses associated with each of the WAN connections. Static IP addresses that are not associated with any WAN can be entered into the Custom IP list. A PTR record is also created for each custom IP.</p> <p>For WAN connections that operate under drop-in mode, there may be other routable IP addresses in addition to the default IP address. Therefore, the Peplink Balance allows custom Internet IP addresses to be added manually via filling the text box on the right-hand side and clicking the  button.</p> <p>Only the checked IP addresses in the lists are candidates to be returned when responding to a DNS query.</p> <p>If a WAN connection is down, the corresponding set of IP addresses will not be returned. However, the IP addresses in the Custom IP Address field will always be returned.</p> <p>If the Connection Priority field is set to Custom, you can also specify the usage priority of each WAN connection. Only selected IP address(es) of available connection(s) with the highest priority, and custom IP addresses will be returned. By default, Connection Priority is set to Default.</p>

PTR Records

PTR records are created along with A records pointing to custom IPs. For example, if you created an A record *www.mydomain.com* pointing to *11.22.33.44*, then a PTR record *44.33.22.11.in-addr.arpa* pointing to *www.mydomain.com* will also be created. When there are multiple host names pointing to the same IP address, only one PTR record for the IP address will be created. In order for PTR records to function, you also need to create NS records. For example, if the IP address range *11.22.33.0* to *11.22.33.255* is delegated to the DNS server on the Peplink Balance, you will also have to create a domain *33.22.11.in-addr.arpa* and have its NS records pointing to your DNS server's (the Peplink Balance's) public IP addresses. With the above records created, the PTR record creation is complete.

TXT Records

This table shows the TXT record of the domain name.

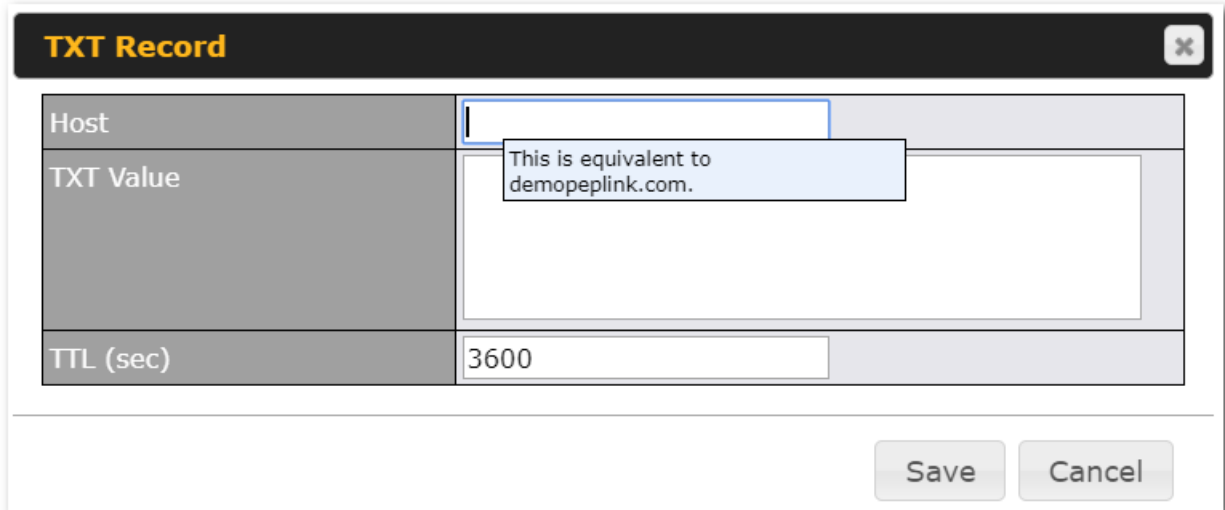

TXT Record	
Host	<input type="text"/>
TXT Value	<input type="text" value="This is equivalent to demopeplink.com."/>
TTL (sec)	<input type="text" value="3600"/>

Save Cancel

To add a new TXT record, click the **New TXT Record** button in the **TXT Records** box. Click the **Edit** button to edit the record. The time-to-live value and the TXT record's value can be entered. Click the **Save** button to finish.

When creating a TXT record for the domain itself (not a sub-domain), the **Host** field should be left blank.

The maximum size of the TXT Value is 255 bytes.

After editing the five types of records, you can leave the page by simply going to another section of the web admin interface.

SRV Records

To add a new SRV record, click the **New SRV Record** button in the **SRV Records** box.

Priority	Weight	Target	Port	TTL (sec)	
				3600	+

- **Service:** The symbolic name of the desired service.
- **Priority:** Indicates the priority of the target; the smaller the value, the higher the priority.
- **Weight:** A relative weight for records with the same priority.
- **Target:** The canonical hostname of the machine providing the service.
- **Port:** Enter the TCP or UDP port number on which the service is to be found.

Reverse Lookup Zones

Reverse lookup zones can be configured in **Network>Inbound Access>DNS Settings**.

Reverse lookup refers to performing a DNS query to find one or more DNS names associated with a given IP address.

The DNS stores IP addresses in the form of specially formatted names as pointer (PTR) records using special domains/zones. The zone is *in-addr.arpa*.

To enable DNS clients to perform a reverse lookup for a host, perform two steps:

- Create a reverse lookup zone that corresponds to the subnet network address of the host.
In the reverse lookup zone, add a pointer (PTR) resource record that maps the host IP address to the host name.
- Click the **New Reverse Lookup Zone** button and enter a reverse lookup zone name. If

you are delegated the subnet 11.22.33.0/24, the **Zone Name** should be 33.22.11.in-arpa.addr. PTR records for 11.22.33.1, 11.22.33.2, ... 11.22.33.254 should be defined in this zone where the host IP numbers are 1, 2, ... 254, respectively.

33.22.11.in-addr.arpa
✕

SOA Record
?

WARNING: You should define SOA record in your zone!
[Click here to define SOA Record](#)

NS Records
?

Host	Name Server	TTL (sec)	
<p>WARNING: You should define NS records in your zone!</p>			
<input type="button" value="New NS Records"/>			

CNAME Records
?

Host	Points To	TTL (sec)	
<p>There is currently no CNAME records.</p>			
<input type="button" value="New CNAME Record"/>			

PTR Records
?

Host IP Number	Points To	TTL (sec)	
<p>There is currently no PTR records.</p>			
<input type="button" value="New PTR Record"/>			

SOA Record

You can click the link [Click here to define SOA record](#) to create or click on the **Name Server** field to edit the SOA record.

SOA Record

Name Server	<input type="text"/>
Email	<input type="text" value="webmaster"/>
Refresh (sec)	<input type="text" value="14400"/>
Retry (sec)	<input type="text" value="900"/>
Expire (sec)	<input type="text" value="1209600"/>
Min Time (sec)	<input type="text" value="3600"/>
TTL (sec)	<input type="text" value="3600"/>

Name Server: Enter the NS record's FQDN server name here.

For example:

"ns1.mydomain.com" (equivalent to "www.1stdomain.com.")

"ns2.mydomain.com."

Email, Refresh, Retry, Expire, Min Time, and TTL are entered in the same way as in the forward zone. Please refer to **Section 17.3.5** for details.

NS Records

NS Records
✕

Host	<input type="text"/>
This is equivalent to 33.22.11.in-addr.arpa.	
Name Server	<input type="text"/>
TTL (sec)	3600 +

Save
Cancel

The NS record of the name server defined in the SOA record is automatically added here. To create a new NS record, click the **New NS Records** button.

When creating an NS record for the *reverse lookup zone* itself (not a sub-domain or dedicated zone), the **Host** field should be left blank. **Name Server** must be a FQDN.

CNAME Records

CNAME Record
✕

Host	<input type="text"/>
Points To	<input type="text"/>
This is equivalent to 33.22.11.in-addr.arpa.	
TTL (sec)	3600

Save
Cancel

To create a new CNAME record, click the **New CNAME Record** button.

CNAME records are typically used for defining classless reverse lookup zones. Subnetted reverse lookup zones are further described in RFC 2317, "Classless IN-ADDR.ARPA delegation."

PTR Records

PTR Record	
Host IP Number	<input type="text"/>
Points To	<input type="text"/> This is equivalent to 33.22.11.in-addr.arpa.
TTL (sec)	<input type="text" value="3600"/>

To create a new PTR record, click the **New PTR Record** button.

For **Host IP Number** field, enter the last integer in the IP address of a PTR record. For example, for the IP address *11.22.33.44*, where the reverse lookup zone is *33.22.11.in-addr.arpa*, the **Host IP Number** should be *44*.

The **Points To** field defines the host name which the PTR record should be pointed to. It must be a FQDN.

DNS Record Import Wizard

At the bottom of the DNS settings page, the link **Import records via zone transfer...** is used to import DNS record using an import wizard.

DNS Record Import Wizard

This wizard allows you to import DNS records from an existing DNS server via zone transfer.

Requirement: Your existing DNS server is configured to allow one of the WAN's default IP addresses to transfer DNS zone records.

To continue, click Next.

- Select **Next >>** to continue.

DNS Record Import Wizard ✕

Step 1 of 3

Target DNS Server IP Address:

Transfer via...

WAN 1 ▾

<< Back
Next >>
Cancel

- In the **Target DNS Server IP Address** field, enter the IP address of the DNS server.
- In the **Transfer via...**field, choose the connection which you would like to transfer through.
- Select **Next >>** to continue.

DNS Record Import Wizard ✕

Step 2 of 3

Domain Names (Zones):

mycompany.com
 peplink.com

(One domain name per line)

<< Back
Next >>
Cancel

- In the blank space, enter the **Domain Names (Zones)** which you would like to assign the IP address entered in the previous step. Enter one domain name per line.
- Select **Next >>** to continue.

Important Note

If you have entered domain(s) which already exist in your settings, a warning message will appear. Select **Next >>** to overwrite the existing record or **<< Back** to go back to the previous step.

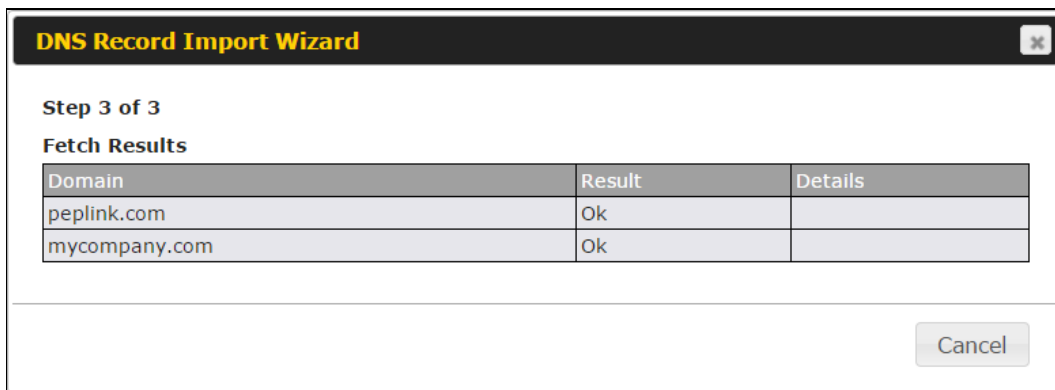
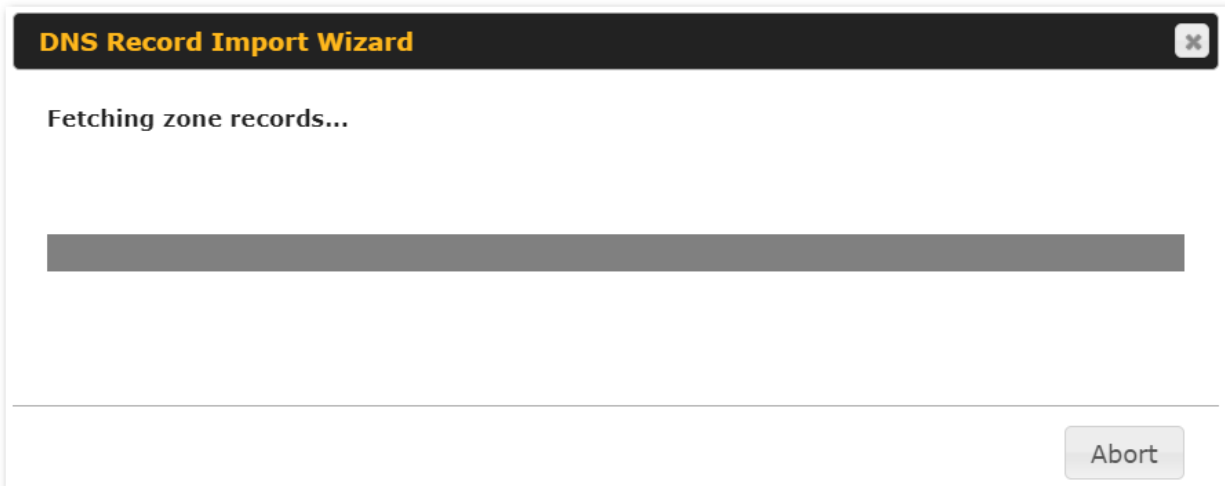
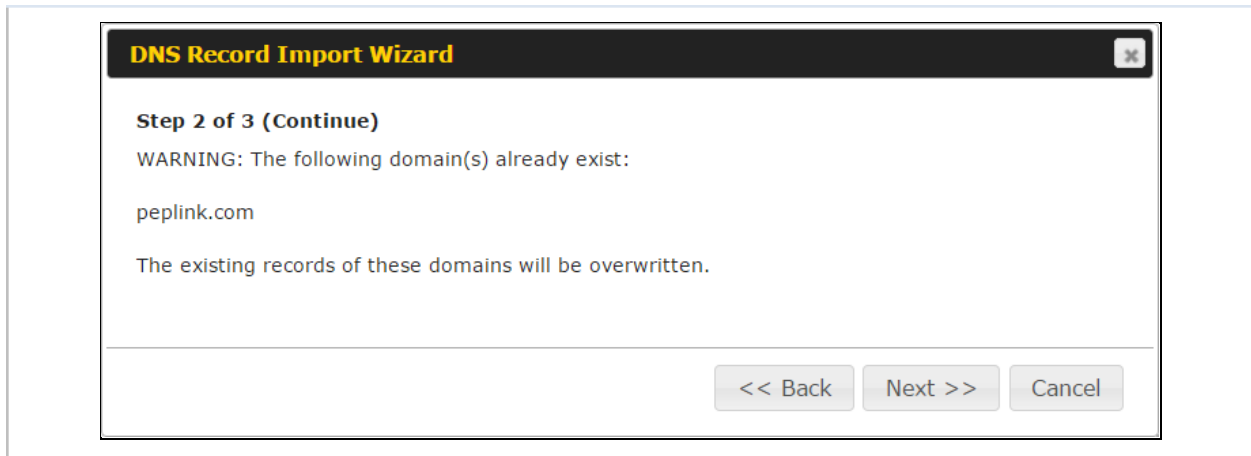

After the zone records process have been fetched, the fetch results would be shown as above. You can view import details by clicking the corresponding hyperlink on the right-hand side.

Zone: mytest.com

Record Type	Name	Value
SOA	mytest.com	ns1.mytest.com.
NS	mytest.com	ns1.mytest.com.
NS	mytest.com	ns2.mytest.com.
NS	mytest.com	ns3.mytest.com.
NS	mytest.com	ns4.mytest.com.
MX	mytest.com	mail01.mytest.com.
MX	mytest.com	1.us.testinglabs.com.
MX	mytest.com	backup.mytest.com.
MX	mytest.com	2.us.testinglabs.com.
A	backup.mytest.com	210.120.111.12
A	download.mytest.com	33.11.22.33
A	guest.mytest.com	126.132.111.0

13.6 NAT Mappings

The Peplink Balance allows the IP address mapping of all inbound and outbound NATed traffic to and from an internal client IP address.

NAT mappings can be configured at **Network>NAT Mappings**.

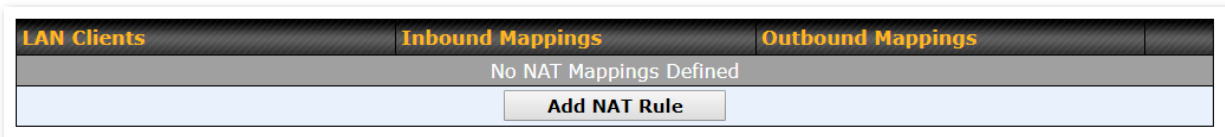

To add a rule for NAT mappings, click **Add NAT Rule** and the following screen will be displayed:

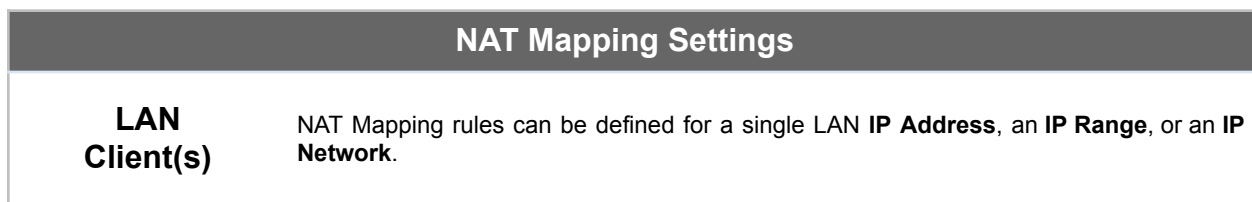
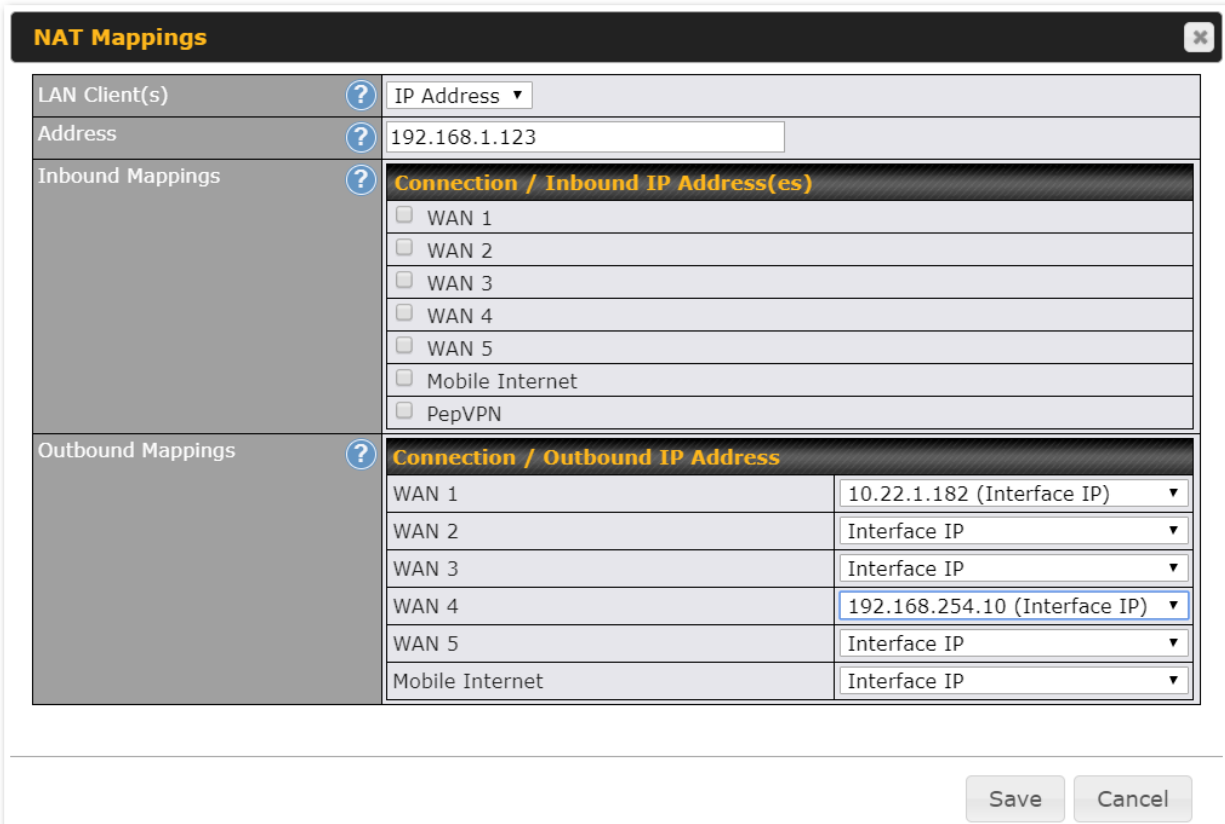

Address	This refers to the LAN host's private IP address. The system maps this address to a number of public IP addresses (specified below) in order to facilitate inbound and outbound traffic. This option is only available when IP Address is selected.
Range	The IP range is a contiguous group of private IP addresses used by the LAN host. The system maps these addresses to a number of public IP addresses (specified below) to facilitate outbound traffic. This option is only available when IP Range is selected.
Network	The IP network refers to all private IP addresses and ranges managed by the LAN host. The system maps these addresses to a number of public IP addresses (specified below) to facilitate outbound traffic. This option is only available when IP Network is selected.
Inbound Mappings	<p>This setting specifies the WAN connections and corresponding WAN-specific Internet IP addresses on which the system should bind. Any access to the specified WAN connection(s) and IP address(es) will be forwarded to the LAN host. This option is only available when IP Address is selected in the LAN Client(s) field.</p> <p>Note 1: Inbound mapping is not needed for WAN connections in drop-in mode or IP forwarding mode.</p> <p>Note 2: Each WAN IP address can be associated to one NAT mapping only.</p>
Outbound Mappings	<p>This setting specifies the WAN IP addresses should be used when an IP connection is made from a LAN host to the Internet.</p> <p>Each LAN host in an IP range or IP network will be evenly mapped to one of each selected WAN's IP addresses (for better IP address utilization) in a persistent manner (for better application compatibility).</p> <p>Note 1: If you do not want to use a specific WAN for outgoing accesses, you should still choose default here, then customize the outbound access rule in the Outbound Policy section.</p> <p>Note 2: WAN connections in drop-in mode or IP forwarding mode are not shown here.</p>

Click **Save** to save the settings when configuration has been completed.

Important Note

Inbound firewall rules override inbound mapping settings.

13.7 MediaFast

MediaFast settings can be configured by navigating to **Network > MediaFast**.

Setting Up MediaFast Content Caching

To access MediaFast content caching settings, select **Network > MediaFast**.

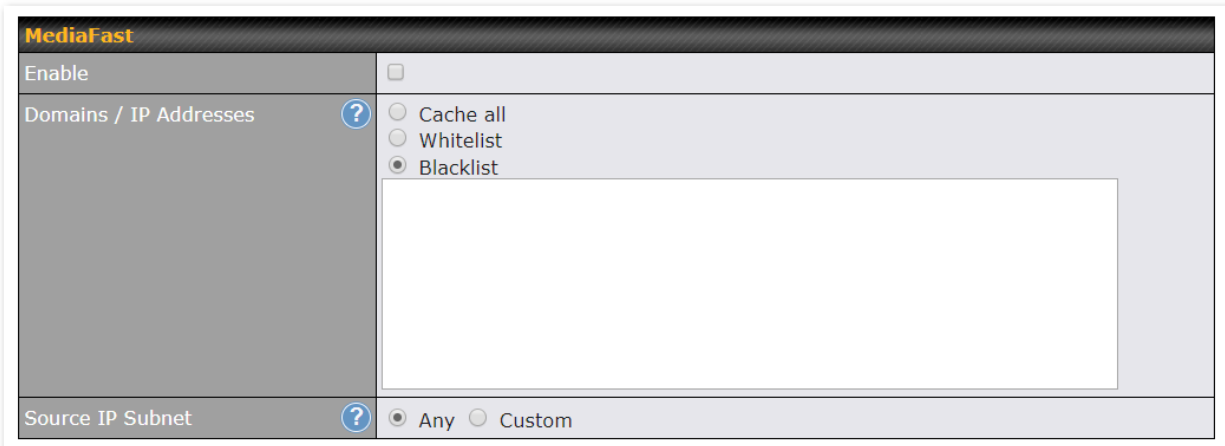

MediaFast	
Enable	Click the checkbox to enable MediaFast content caching.
Domains / IP Addresses	Choose to Cache on all domains , or enter domain names and then choose either Whitelist (cache the specified domains only) or Blacklist (do not cache the specified domains).
Source IP Subnet	This setting allows caching to be enabled on custom subnets only. If "Any" is selected, then caching will apply to all subnets.

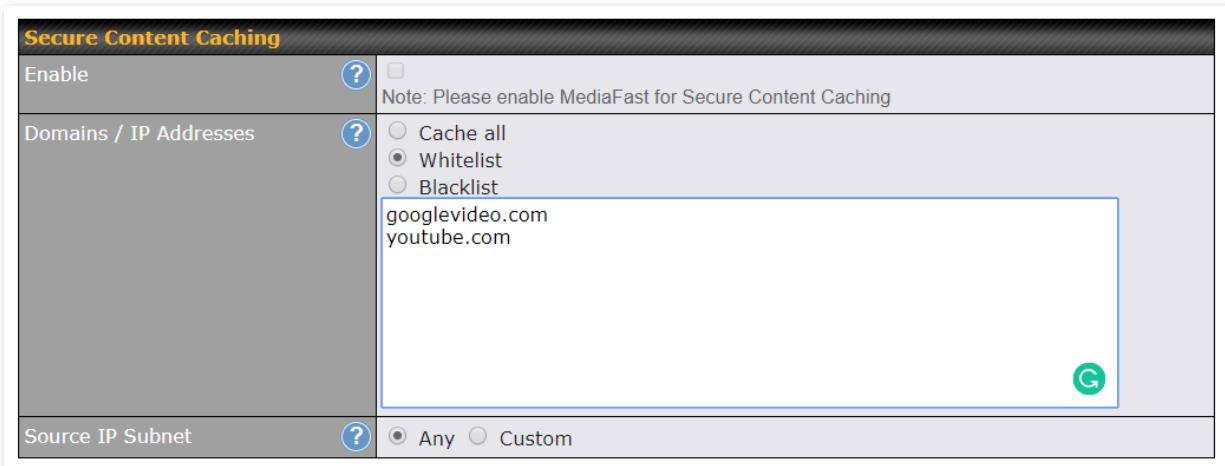

The **Secure Content Caching** menu operates identically to the **MediaFast** menu, except it is for secure content caching accessible through https://. In order for Mediafast devices to cache and deliver HTTPS content, every client needs to have the necessary certificates installed*.

*See <https://forum.peplink.com/t/certificate-installation-for-mediafast-https-caching/>

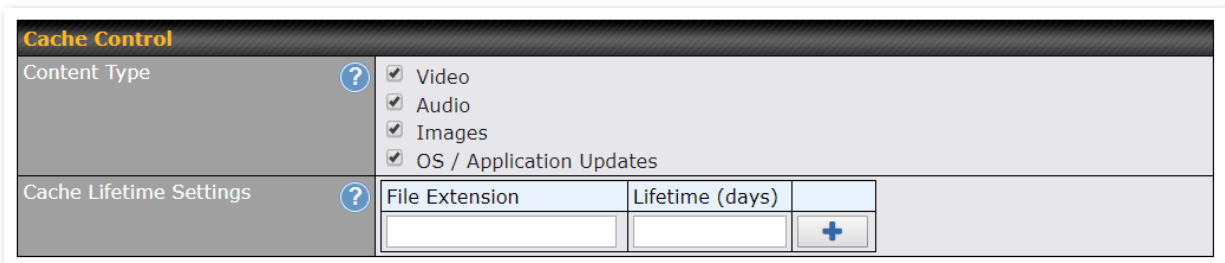

Cache Control	
Content Type	Check these boxes to cache the listed content types or leave boxes unchecked to disable caching for the listed types.
Cache Lifetime Settings	Enter a file extension, such as JPG or DOC. Then enter a lifetime in days to specify how long files with that extension will be cached. Add or delete entries using the controls on the right.

Viewing MediaFast Statistics

To get details on storage and bandwidth usage, select **Status>MediaFast**.

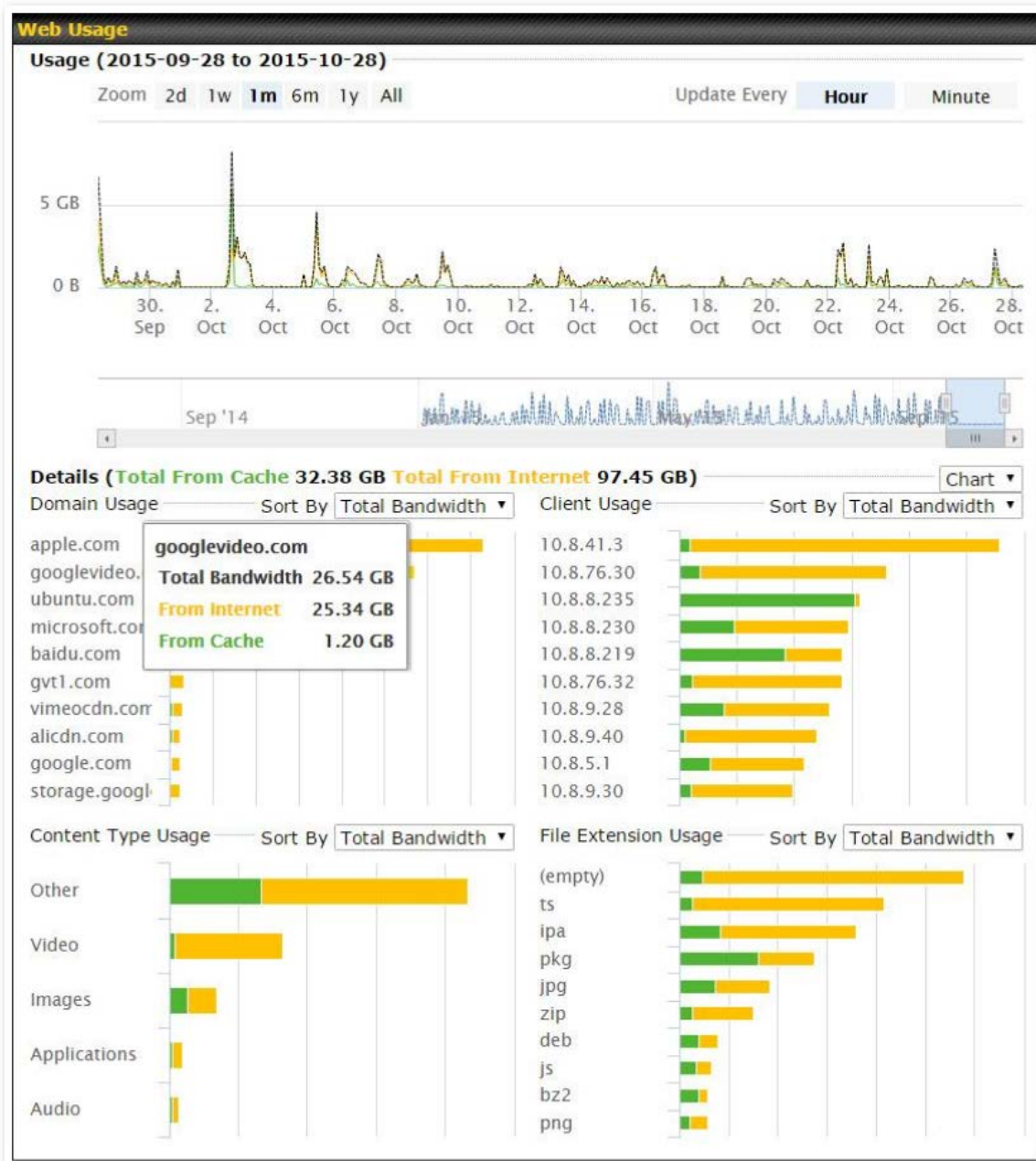

Prefetch Schedule

Content prefetching allows you to download content on a schedule that you define, which can help to preserve network bandwidth during busy times and keep costs down. To access MediaFast content prefetching settings, select **Network > MediaFast > Prefetch Schedule**.

Prefetch Schedule

Name	Status	Next Run Time	Last Run Time	Last Duration	Result	Last Download	Actions
▶ Course Progress	Downloading	04-11 06:00	04-09 02:03	-		0 B	
▶ National Geog	Ready	04-11 00:00	04-09 00:00	00:01		4.98 kB	
▶ Syllabus	Downloading	04-11 06:00	04-09 06:00	-		0 B	
▶ Vimeo	Ready	04-11 00:00	04-09 02:03	00:01		115.91 kB	
▶ ted	Ready	04-11 00:00	04-09 00:00	00:01		62.26 kB	

[New Schedule](#)

Tools

[Clear Web Cache](#) [Clear Statistics](#)

Prefetch Schedule Settings	
Name	This field displays the name given to the scheduled download.
Status	Check the status of your scheduled download here.
Next Run Time/Last Run Time	These fields display the date and time of the next and most recent occurrences of the scheduled download.
Last Duration	Check this field to ensure that the most recent download took as long as expected to complete. A value that is too low might indicate an incomplete download or incorrectly specified download target, while a value that is too long could mean a download with an incorrectly specified target or stop time.
Result	This field indicates whether downloads are in progress () or complete ().
Last Download	Check this field to ensure that the most recent download file size is within the expected range. A value that is too low might indicate an incomplete download or incorrectly specified download target, while a value that is too long could mean a download with an incorrectly specified target or stop time. This field is also useful for quickly seeing which downloads are consuming the most storage space.
Actions	<p>To begin a scheduled download immediately, click .</p> <p>To cancel a scheduled download, click .</p> <p>To edit a scheduled download, click .</p> <p>To delete a scheduled download, click .</p>
New Schedule	Click to begin creating a new scheduled download. Clicking the button will cause the following screen to appear:

MediaFast Schedule
✕

Name (optional)	<input style="width: 90%;" type="text"/>	
Active	<input checked="" type="checkbox"/>	
URL	<input style="width: 70%;" type="text"/>	+
Depth	2 ▾ levels Default	
Time Period	From 00 ▾ : 00 ▾ to 01 ▾ : 00 ▾	
Repeat	Everyday ▾	
Bandwidth Limit	0 <input style="width: 40px;" type="text"/> Gbps ▾ (0: Unlimited)	

Simply provide the requested information to create your schedule.

Clear Web Cache	Click to clear all cached content. Note that this action cannot be undone.
Clear Statistics	Click to clear all prefetch and status page statistics.

13.8 ContentHub

ContentHub allows you to deliver webpages and applications to users connected to the SSID using the local storage on your router. Users will be able to access news, articles, videos, and access your web app without the need for internet access.

The ContentHub can be used to provide infotainment to connected users on transport.

ContentHub storage needs to be configured before content can be uploaded to the ContentHub. Click on the link on the information panel to configure storage.

ContentHub storage has not been configured. Click [here](#) to review storage configuration

To access ContentHub, navigate to **Network > ContentHub** and check the **Enable** box.:

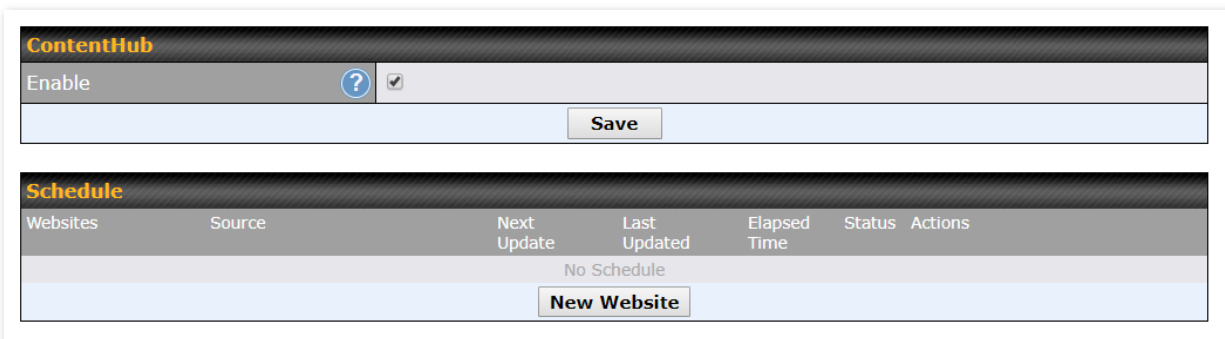

ContentHub

Enable [?](#)

Save

Schedule

Websites	Source	Next Update	Last Updated	Elapsed Time	Status	Actions
No Schedule						

New Website

On an external server, configure content (a website or application) that will be synced to the ContentHub. For example, an html5 website.

To configure a website or application as content, follow the steps below.

Configure a website for the ContentHub

This option allows you to sync a website to the Peplink router. This website will then be published with the specified domain from the router itself and makes the content available to the client via the HTTP/HTTPS protocol.

Only FTP sync is supported for this type of ContentHub content.

The content should be uploaded to an FTP server before you sync it with ContentHub.

Click **New Website** and a window with the following configuration options will appear:

Schedule
✕

Active	<input checked="" type="checkbox"/>
Type	<input checked="" type="radio"/> Website <input type="radio"/> Application
Protocol	HTTP ▾
Domain/Path	? http:// <input style="width: 150px;" type="text"/>
Source	<div style="display: flex; align-items: flex-start;"> <div style="margin-right: 10px;"> ftp ▾ :// Username: Password: </div> <div style="border: 1px solid #ccc; width: 150px; height: 20px; margin-bottom: 5px;"></div> <div style="border: 1px solid #ccc; width: 150px; height: 20px; margin-bottom: 5px;"></div> <div style="border: 1px solid #ccc; width: 150px; height: 20px;"></div> </div>
Period	Everyday ▾ From 00 ▾ : 00 ▾ to 01 ▾ : 00 ▾
Bandwidth Limit	<input style="width: 50px;" type="text" value="0"/> Gbps ▾ (0: Unlimited)

Schedule	
Active	Checking the box toggles the activation of the content.
Type	Select the type of content: Website or Application.
Protocol	Configure the protocol to be used: HTTP, HTTPS or both.
Domain/Path	Enter the URL for the ContentHub to use as the domain name for client access (such as http://mytest.com).
Method	Only applicable for Application type content. Choose between sync or file upload.
Source	Enter the details of the server that the content will be downloaded from. Enter credentials under Username and Password .
Period	This field determines how often the router will search for updates to the source content.
Bandwidth Limit	Set a bandwidth limit for clients.

Click **“Save & Apply Now”** to activate the changes. A screenshot of the display after configuration is shown below:

Websites	Source	Next Update	Last Updated	Elapsed Time	Status	Actions
▼ http://mytest.com						+ [edit] [delete]
/(root)	ftp://10.8.76.254/web...	-	-	-		↓ [share] [edit] [delete]

New Website

The content will be synced regularly according to the time set in the **Period** that was configured earlier.

If you want to activate the sync manually, you can click the “” icon. The “Status” column will display the sync progress. When the sync is completed, a summary will be displayed, as shown in the screenshot below:

Websites	Source	Next Update	Last Updated	Elapsed Time	Status	Actions
▼ http://mytest.com						+ [edit] [delete]
/(root)	ftp://10.8.76.254/web...	-	05-23 03:41	00:00:11	✓	↓ [share] [edit] [delete]

New Website

Status details Close
 Completed
 +1 / 0 / -0 files

To access the content, open a browser in the MFA’s client and enter the domain details that were configured earlier (such as <http://mytest.com>).

Configure an application for the ContentHub

MediaFast routers allow you to configure and publish any application from the router itself by using one of the supported frameworks below:

- Python (version 2.7.12)
- Ruby (version 2.3.3)
- Node.js (version 6.9.2)

Install the desired framework under “Package Manager” as shown below:

(Last Update: Tue May 23 04:02:36 UTC 2017)

Package List		Update All
Node.js Version: 6.9.2 (17178) Size: 8.99 MB Date: Fri Feb 24 07:45:28 UTC 2017		
Python Version: 2.7.12 (17178) Size: 20.29 MB Date: Fri Feb 24 07:45:28 UTC 2017		
Ruby Version: 2.3.3 (17178) Size: 31.44 MB Date: Fri Feb 24 07:45:30 UTC 2017		

After installing the framework, change the "Type" to "Application" and configure the website.

Schedule
✕

Active	<input checked="" type="checkbox"/>
Type	<input type="radio"/> Website <input checked="" type="radio"/> Application
Protocol	HTTP
Domain	http:// <input type="text"/>
Method	<input checked="" type="radio"/> Sync <input type="radio"/> File Upload
Source	ftp :// <input type="text"/> Username: <input type="text"/> Password: <input type="text"/>
Period	Everyday From 00:00 to 01:00
Bandwidth Limit	0 Gbps (0: Unlimited)

The setting is the same as the Website type (refer to the description in the section above).

Application type content need to be packed as explained below:

1. Implement two bash script files, start.sh and stop.sh in the root folder, to start and stop your application. The MediaFast router will only execute start.sh and stop.sh when the corresponding website is enabled and disabled respectively.
2. Compress the application files and the bash script to .tar.gz format.
3. Upload this tar file to the router.

MDM Settings

In addition to performing content caching, MediaFast-enabled routers can also serve as an MDM, administrating to client devices. To access MDM Settings, navigate to **Network > MDM Settings**:

MDM Settings	
Enable	<input checked="" type="checkbox"/>
Account Settings	<input type="radio"/> Follow Web Admin Account <input checked="" type="radio"/> Custom
Username	<input type="text"/>
Password	<input type="password"/>
Confirm Password	<input type="password"/>

MDM Settings	
Enable	Click this checkbox to enable MDM on your router.
Account Settings	Click Follow Web Admin Account to allow client devices to use the built-in administrator account when performing MDM. Set Custom to specify a username and password your router will use to log into your client devices.

Please refer to the knowledgebase for information about enrolling client devices to MDM:
<https://forum.peplink.com/t/how-to-enroll-a-device-to-the-mdm-server/8454>

Docker

MediaFast enabled routers can host Docker containers when running Firmware 7.1 or later. Docker is an open platform for developing, shipping, and running applications. From Firmware version 7.1.0 and upwards, it is possible to install and run Docker Containers on your Peplink Mediafast 500 or 750 router.

Due to the nature of Docker and its unlimited variables, this feature is supported by Pepwave up to the point of creating a running Docker Container.

Information about Docker can be found on the Docker Documentation site:
<https://docs.docker.com/> 2

This will allow you to run a file sharing platform (ownCloud), a web server (WordPress, Joomla!), a learning platform (Moodle), or a visualisation tool for viewing large scale data (Kibana). When creating a new Docker Container, the Pepwave router will search through the Docker Hub repository. <https://hub.docker.com/explore/> 7

For detailed configuration instructions, refer to our knowledge base:

<https://forum.peplink.com/t/how-to-run-a-docker-application-on-a-peplink-mediafast-router/1602>
 1

KVM

MediaFast enabled routers now support KVM. Users will have to download and install Virtual Machine Manager to manage the KVM virtual machines. Through this, users are able to virtualise a Linux environment.

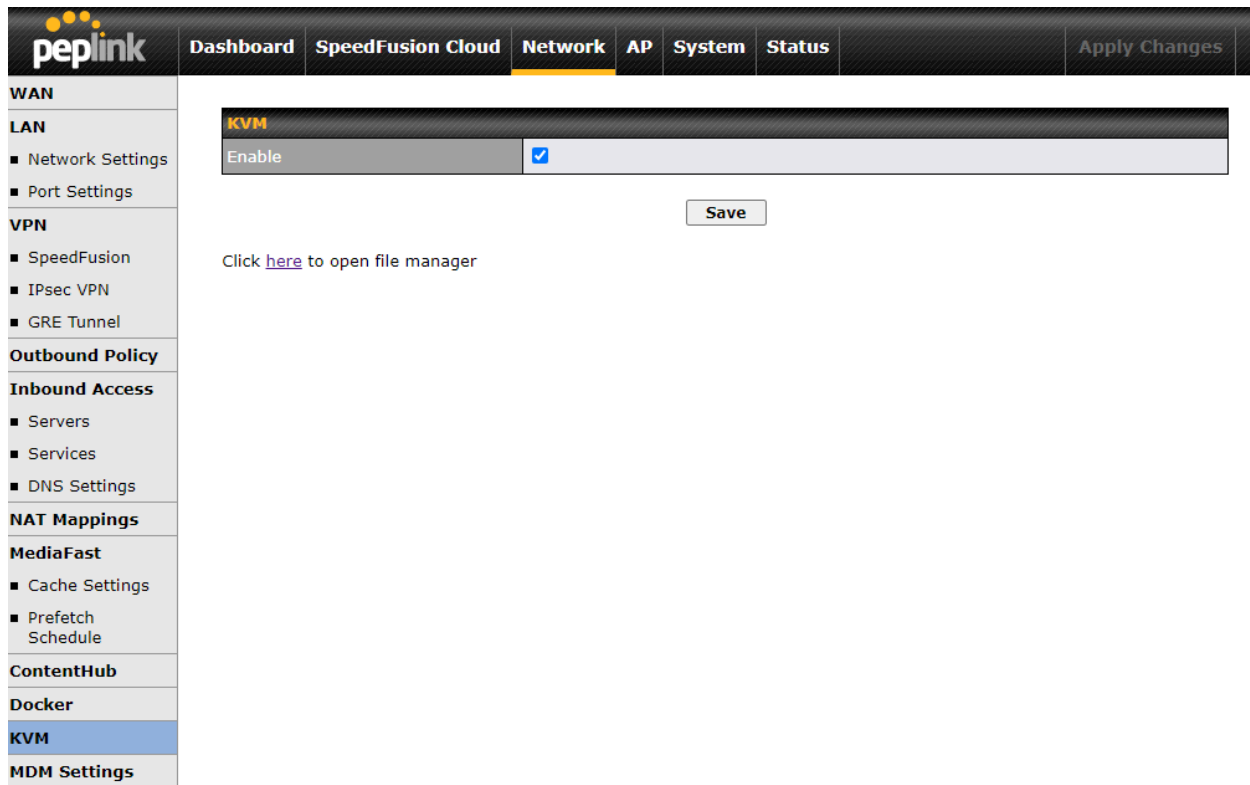

The screenshot shows the Peplink web interface with the following elements:

- Navigation Bar:** Dashboard, SpeedFusion Cloud, **Network**, AP, System, Status, Apply Changes
- Left Sidebar:** WAN, LAN (Network Settings, Port Settings), VPN (SpeedFusion, IPsec VPN, GRE Tunnel), Outbound Policy, Inbound Access (Servers, Services, DNS Settings), NAT Mappings, MediaFast (Cache Settings, Prefetch Schedule), ContentHub, Docker, **KVM**, MDM Settings
- Main Content Area:**
 - KVM Section:** A header bar with 'KVM' and a sub-section with 'Enable' and a checked checkbox.
 - Buttons:** A 'Save' button is located below the checkbox.
 - Text:** 'Click [here](#) to open file manager'

For detailed configuration instructions, refer to our knowledge base articles:

1. [How to install a Virtual Machine on Peplink/Peplink - MediaFast/ContentHub Routers](#)
2. [How to Install Virtual Machine with USB storage on Peplink/Peplink - MediaFast/ContentHub Routers](#)

13.9 Captive Portal

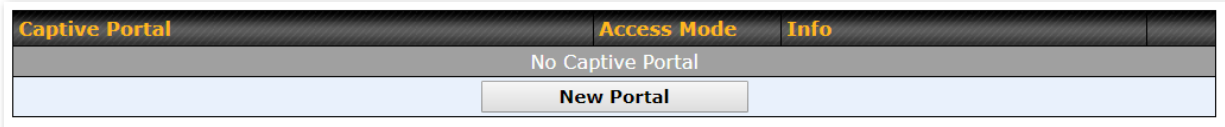

The captive portal serves as a gateway that clients have to pass if they wish to access the Internet using your router. To configure, navigate to **Network > Captive Portal**.

Captive Portal ✕

General Settings

Name	<input type="text" value="demoportal"/>	
Enable	<input type="checkbox"/>	
Hostname	<input type="text" value="captive-portal.peplink.com"/> Default	
Access Mode	<input checked="" type="radio"/> Open Access <input type="radio"/> User Authentication <input type="radio"/> External Server	



Portal Access Settings



Access Quota	<input type="text" value="30"/> mins (0: Unlimited) <input type="text" value="0"/> MB (0: Unlimited)
Quota Reset Time	<input checked="" type="radio"/> Daily at <input type="text" value="00"/> :00 <input type="radio"/> <input type="text" value="1440"/> minutes after quota reached
Inactive Timeout	<input type="text" value="0"/> minutes (0: No Timeout)
Allowed Networks	<input type="text" value="Domain Name / IP Address / Network"/> +
Allowed Clients	<input type="text" value="MAC / IP Address"/> +
Splash Page	<input checked="" type="radio"/> Built-in <input type="radio"/> External, URL: <input type="text" value="http://"/>
Popup Handling	<input type="checkbox"/> Bypass Popup (Redirection only takes place on normal browser) <input type="checkbox"/> Automatically show splash page on Safari for Apple (iOS / macOS) devices
Logout Hostname	<input type="text" value="(Not configured)"/>

Click [here](#) to preview / customize built-in splash page

Captive Portal Settings

Enable	Check Enable and then, optionally, select the LANs/VLANs that will use the captive portal.
---------------	---

<p>Hostname</p>	<p>To customize the portal's form submission and redirection URL, enter a new URL in this field. To reset the URL to factory settings, click Default.</p>																					
<p>Access Mode</p>	<p>Click Open Access to allow clients to freely access your router. Click User Authentication to force your clients to authenticate before accessing your router. Select External Server to use the Captive Portal with a HotSpot system. As described in the following knowledgebase article: https://forum.peplink.com/t/using-hotspotsystem-wi-fi-on-pepwave-max-routers/</p>																					
<p>RADIUS Server</p>	<p>This authenticates your clients through a RADIUS server. After selecting this option, you will see the following fields:</p> <table border="1" data-bbox="553 636 1378 833"> <tr> <td>Authentication</td> <td colspan="2">RADIUS Server ▾</td> </tr> <tr> <td>Auth Server</td> <td><input type="text"/></td> <td>Port 1812 Default</td> </tr> <tr> <td>Auth Server Secret</td> <td><input type="text"/></td> <td><input checked="" type="checkbox"/> Hide Characters</td> </tr> <tr> <td>CoA-DM</td> <td colspan="2"><input type="checkbox"/></td> </tr> <tr> <td>Accounting Server</td> <td><input type="text"/></td> <td>Port 1813 Default</td> </tr> <tr> <td>Accounting Server Secret</td> <td><input type="text"/></td> <td><input checked="" type="checkbox"/> Hide Characters</td> </tr> <tr> <td>Accounting Interim Interval</td> <td><input type="text"/></td> <td>seconds</td> </tr> </table> <p>Fill in the necessary information to complete your connection to the server and enable authentication.</p>	Authentication	RADIUS Server ▾		Auth Server	<input type="text"/>	Port 1812 Default	Auth Server Secret	<input type="text"/>	<input checked="" type="checkbox"/> Hide Characters	CoA-DM	<input type="checkbox"/>		Accounting Server	<input type="text"/>	Port 1813 Default	Accounting Server Secret	<input type="text"/>	<input checked="" type="checkbox"/> Hide Characters	Accounting Interim Interval	<input type="text"/>	seconds
Authentication	RADIUS Server ▾																					
Auth Server	<input type="text"/>	Port 1812 Default																				
Auth Server Secret	<input type="text"/>	<input checked="" type="checkbox"/> Hide Characters																				
CoA-DM	<input type="checkbox"/>																					
Accounting Server	<input type="text"/>	Port 1813 Default																				
Accounting Server Secret	<input type="text"/>	<input checked="" type="checkbox"/> Hide Characters																				
Accounting Interim Interval	<input type="text"/>	seconds																				
<p>LDAP Server</p>	<p>This authenticates your clients through a LDAP server. Upon selecting this option, you will see the following fields:</p> <table border="1" data-bbox="553 1056 1373 1207"> <tr> <td>Authentication</td> <td colspan="2">LDAP Server ▾</td> </tr> <tr> <td>LDAP Server</td> <td><input type="text"/></td> <td>Port 389 Default</td> </tr> <tr> <td></td> <td colspan="2"><input type="checkbox"/> Use DN/Password to bind to LDAP Server</td> </tr> <tr> <td>Base DN</td> <td colspan="2"><input type="text"/></td> </tr> <tr> <td>Base Filter</td> <td colspan="2"><input type="text"/></td> </tr> </table> <p>Fill in the necessary information to complete your connection to the server and enable authentication.</p>	Authentication	LDAP Server ▾		LDAP Server	<input type="text"/>	Port 389 Default		<input type="checkbox"/> Use DN/Password to bind to LDAP Server		Base DN	<input type="text"/>		Base Filter	<input type="text"/>							
Authentication	LDAP Server ▾																					
LDAP Server	<input type="text"/>	Port 389 Default																				
	<input type="checkbox"/> Use DN/Password to bind to LDAP Server																					
Base DN	<input type="text"/>																					
Base Filter	<input type="text"/>																					
<p>Access Quota</p>	<p>Set a time and data cap to each user's Internet usage.</p>																					
<p>Quota Reset Time</p>	<p>This menu determines how your usage quota resets. Setting it to Daily will reset it at a specified time every day. Setting a number of minutes after quota reached establish a timer for each user that begins after the quota has been reached.</p>																					
<p>Inactive Timeout</p>	<p>Clients will get disconnected when the inactive the configured time is reached. Default 0: no timeout</p>																					
<p>Allowed Networks</p>	<p>To whitelist a network, enter the domain name / IP address here and click  . To delete an existing network from the list of allowed networks, click the  button next to the listing.</p>																					

Allowed Clients	To whitelist a client, enter the MAC address / IP address here and click  . To delete an existing client from the list of allowed clients, click the  button next to the listing.
Splash Page	Here, you can choose between using the Balance's built-in captive portal and redirecting clients to a URL you define.
Popup Handling	Configurable options for popup handling: - Bypass Popup (Redirection only takes place on normal browser) - Automatically show splash page on Safari for Apple (iOS / macOS) devices
Logout Hostname	A hostname that can be used to logout captive portal when being accessed on browser.
Customize splash page	Click on the provided link in the Captive portal profile to customize the splash page. A new browser tab is opened with a WYSIWYG editor of the splash page o edit the content, click on the corresponding element after switching Edit Mode to ON.

Captive Portal



Use default Logo Image

Choose File

NOTE: Size max 512KB. Supported images types: JPEG, PNG and GIF.

EMPTY STRING

I have read and agree to the [terms and conditions](#) ?

You must accept the terms and conditions before you can proceed

[Agree](#)

Powered by Peplink.

Portal Configuration

Show Quota Status	<input checked="" type="checkbox"/>
Custom Landing Page	<input type="checkbox"/>

Page: Login

- Login
- TNC
- Success
- Quota reached

Edit mode ON ?

[Save](#)

13.10 QoS

13.10.1 User Groups

LAN and PPTP clients can be categorized into three user groups - **Manager, Staff, and Guest**. This menu allows you to define rules and assign client IP addresses or subnets to a user group. You can apply different bandwidth and traffic prioritization policies on each user group in the **Bandwidth Control** and **Application** sections.

The table is automatically sorted, and the table order signifies the rules' precedence. The smaller and more specific subnets are put towards the top of the table and have higher precedence; larger and less specific subnets are placed towards the bottom.

Click the **Add** button to define clients and their user group. Click the  button to remove the defined rule.

Two default rules are predefined and put at the bottom. They are **All DHCP reservation clients** and **Everyone**, and they cannot be removed. The **All DHCP reservation client represents** the LAN clients defined in the DHCP Reservation table on the LAN settings page. **Everyone** represents all clients that are not defined in any rule above. Click on a rule to change its group.

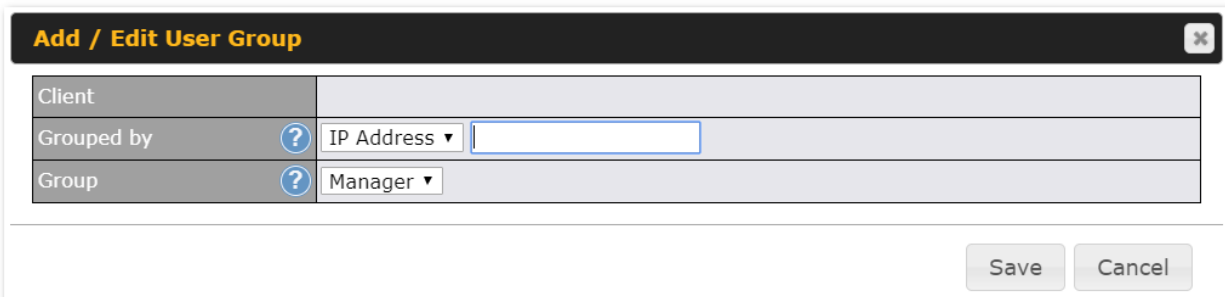

Add / Edit User Group	
Client	
Grouped by	IP Address <input type="text"/>
Group	Manager

Save Cancel

Add / Edit User Group	
Subnet / IP Address	From the drop-down menu, choose whether you are going to define the client(s) by an IP Address or a Subnet . If IP Address is selected, enter a name defined in DHCP reservation table or a LAN client's IP address. If Subnet is selected, enter a subnet address and specify its subnet mask.
Group	This field is to define which User Group the specified subnet / IP address belongs to.

Once users have been assigned to a user group, their internet traffic will be restricted by rules defined for that particular group. Please refer to the following two sections for details.

13.10.2 Bandwidth Control

This section is to define how much minimum bandwidth will be reserved to each user group when a WAN connection is **in full load**. When this feature is enabled, a slider with two indicators will be shown. You can move the indicators to adjust each group's weighting. The

lower part of the table shows the corresponding reserved download and uploads bandwidth value of each connection.

By default, **50%** of bandwidth has been reserved for Manager, **30%** for Staff, and **20%** for Guest.

Group Bandwidth Reservation			
Enable	<input checked="" type="checkbox"/>		
	 Manager	 Staff	Guest
Bandwidth %	50%	30%	20%
WAN 1	500.0M/500.0M	300.0M/300.0M	200.0M/200.0M

You can define a maximum download speed (over all WAN connections) and upload speed (for each WAN connection) that each individual Staff and Guest member can consume. No limit can be imposed on individual Managers. By default, download and upload bandwidth limits are set to unlimited (set as 0).

Individual Bandwidth Limit					
Enable	<input checked="" type="checkbox"/>				
User Bandwidth Limit	Download		Upload		
	Manager: Unlimited		Unlimited		
Staff:	<input type="text" value="0"/>	Mbps ▾	<input type="text" value="0"/>	Mbps ▾	(0: unlimited)
Guest:	<input type="text" value="0"/>	Mbps ▾	<input type="text" value="0"/>	Mbps ▾	(0: unlimited)

13.10.3 Application

You can choose whether to apply the same prioritization settings to all user groups or customize the settings for each group.

Application Prioritization	
<input checked="" type="radio"/>	Apply same settings to all users
<input type="radio"/>	Customize

Three priority levels can be set for application prioritization: **↑High**, **— Normal**, and **↓Low**. The Peplink Balance can detect various application traffic types by inspecting the packet content. Select an application by choosing a supported application, or by defining a custom application manually. The priority preference of supported applications is placed at the top of the table. Custom applications are at the bottom.

Application	Priority			?
	Manager	Staff	Guest	
All Supported Streaming Applications	↑ High	— Normal	↑ High	✖
All Email Protocols	↑ High	↑ High	↑ High	✖
MySQL	↑ High	— Normal	↓ Low	✖
SIP	↑ High	↓ Low	↓ Low	✖

Add

Prioritization for Custom Application

Click the **Add** button to define a custom application. Click the button  in the **Action** column to delete the custom application in the corresponding row.

When **Supported Applications** is selected, the Peplink Balance will inspect network traffic and prioritize the selected applications. Alternatively, you can select **Custom Applications** and define the application by providing the protocol, scope, port number, and DSCP value.

Add / Edit Application ✖

Type ? Supported Applications Custom Applications

Category ? Miscellaneous

Application ? All Supported Miscellaneous Protocols

- All Supported Miscellaneous Protocols
- HTTP
- NTP
- SNMP
- STUN
- USENET

OK Cancel

Category and **Application** availability will be different across different Peplink Balance models.

DSL/Cable Optimization

DSL/cable-based WAN connections have lower upload bandwidth and higher download bandwidth.

When a DSL/cable circuit's uplink is congested, the download bandwidth will be affected. Users will not be able to download data at full speed until the uplink becomes less congested. **DSL/Cable Optimization** can relieve such an issue. When it is enabled, the download speed will become less affected by the upload traffic. By default, this feature is enabled.

DSL / Cable Optimization ?

Enable

13.11 Firewall

A firewall is a mechanism that selectively filters data traffic between the WAN side (the Internet) and the LAN side of the network. It can protect the local network from potential hacker attacks, access to offensive websites, and/or other inappropriate uses.

The firewall functionality of Peplink Balance supports the selective filtering of data traffic in both directions:

- Outbound (LAN to WAN)
- Inbound (WAN to LAN)
- Internal Network (VLAN to VLAN)

The firewall also supports the following functionality:

- Intrusion detection and DoS prevention
- Web blocking

With SpeedFusion™ enabled, the firewall rules also apply to VPN tunneled traffic. The Firewall function can be found at **Network>Firewall**

13.11.1 Access Rules

The outbound firewall settings are located at **Network>Firewall>Access Rules**.

Rule	Protocol	Source	Destination	Action	
test	Any	Any	Any		
Default	Any	Any	Any		

Add Rule

Click **Add Rule** to display the following screen:

Add a New Outbound Firewall Rule ✕

New Firewall Rule

Rule Name	<input type="text"/>
Enable	<input checked="" type="checkbox"/> Always on ▼
Protocol	? Any ▼ ← :: Protocol Selection Tool :: ▼
Source IP & Port	? Any Address ▼
Destination IP & Port	? Any Address ▼
Action	? <input checked="" type="radio"/> Allow <input type="radio"/> Deny
Event Logging	? <input type="checkbox"/> Enable

The inbound firewall settings are located at **Network>Firewall>Access Rules**.

Inbound Firewall Rules (Drag and drop rows by the left to change rule order)						
Rule	Protocol	WAN	Source	Destination	Action	
test	Any	Any	Any	Any		
Default	Any	Any	Any	Any		
Add Rule						

Click **Add Rule** to display the following window:

Add a New Inbound Firewall Rule ✕

New Firewall Rule

Rule Name	<input type="text"/>
Enable	<input checked="" type="checkbox"/> Always on ▾
WAN Connection	? Any ▾
Protocol	? Any ▾ ← :: Protocol Selection Tool :: ▾
Source IP & Port	? Any Address ▾
Destination IP & Port	? Any Address ▾
Action	? <input checked="" type="radio"/> Allow <input type="radio"/> Deny
Event Logging	? <input type="checkbox"/> Enable

The Internal Network firewall settings are located at **Network>Firewall>Access Rules**.

Internal Network Firewall Rules (Drag and drop rows by the left to change rule order)				
Rule	Protocol	Source	Destination	Action
test	Any	Any	Any	
Default	Any	Any	Any	
Add Rule				

Click **Add Rule** to display the following window:

Add a New Internal Network Firewall Rule

New Firewall Rule	
Rule Name	<input type="text"/>
Enable	<input checked="" type="checkbox"/> Always on ▾
Protocol	? Any ▾ ← :: Protocol Selection :: ▾
Source	? Any Address ▾
Destination	? Any Address ▾
Action	? <input checked="" type="radio"/> Allow <input type="radio"/> Deny
Event Logging	? <input type="checkbox"/> Enable

Save Cancel

Inbound / Outbound / Internal Network Firewall Settings

Rule Name	This setting specifies a name for the firewall rule.
Enable	<p>This setting specifies whether the firewall rule should take effect. If the box is checked, the firewall rule takes effect. If the traffic matches the specified protocol/IP/port, actions will be taken by Peplink Balance based on the other parameters of the rule.</p> <p>If the box is not checked, the firewall rule does not take effect. The Peplink Balance will disregard the other parameters of the rule.</p> <p>Click the dropdown menu next to the checkbox to place this firewall rule on a time schedule.</p>
WAN Connection (Inbound)	Select the WAN connection that this firewall rule should apply to.
Protocol	<p>This setting specifies the protocol to be matched. Via a drop-down menu, the following protocols can be specified:</p> <ul style="list-style-type: none"> • Any • TCP • UDP • ICMP • DSCP • IP <p>Alternatively, the Protocol Selection Tool drop-down menu can be used to automatically fill in the protocol and port number of common Internet services (e.g., HTTP, HTTPS, etc.) After selecting an item from the Protocol Selection Tool drop-down menu, the protocol and port number remains manually modifiable.</p>
Source and	This specifies the source IP address(es) and port number(s) to be matched for the firewall

Port

rule. A single address, or a network, can be specified as the **Source IP & Port** setting, as indicated with the following screenshots:

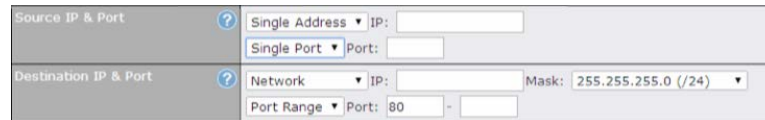

In addition, a single port, or a range of ports, can be specified for the **Source** settings.

Destination and Port

This specifies the destination IP address(es) and port number(s) to be matched for the firewall rule. A single address, or a network, can be specified as the **Destination IP & Port** setting, as indicated with the following screenshots:

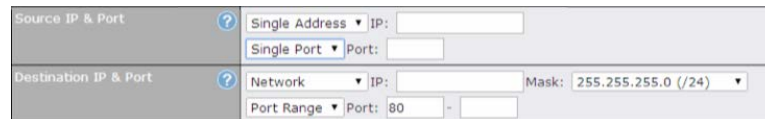

In addition, a single port, or a range of ports, can be specified for the settings.

Action

This setting specifies the action to be taken by the router upon encountering traffic that matches the both of the following:

- Source IP & port
- Destination IP & port

With the value of **Allow** for the **Action** setting, the matching traffic passes through the router (to be routed to the destination). If the value of the **Action** setting is set to **Deny**, the matching traffic does not pass through the router (and is discarded).

Event Logging

This setting specifies whether or not to log matched firewall events. The logged messages are shown on the page **Status>Event Log**. A sample message is as follows:

```
Aug 13 23:47:44 Denied CONN=Ethernet WAN SRC=20.3.2.1
DST=192.168.1.20 LEN=48 PROTO=TCP SPT=2260 DPT=80
```

- **CONN:** The connection where the log entry refers to
- **SRC:** Source IP address
- **DST:** Destination IP address
- **LEN:** Packet length
- **PROTO:** Protocol
- **SPT:** Source port
- **DPT:** Destination port

Click **Save** to store your changes. To create an additional firewall rule, click **Add Rule** and repeat the above steps.

To change a rule's priority, simply drag and drop the rule:

- Hold the left mouse button on the rule.
- Move it to the desired position.
- Drop it by releasing the mouse button.

Outbound Firewall Rules <small>Drag and drop rows to change rule order</small>					
Rule	Protocol	Source IP Port	Destination IP Port	Policy	
No_web_access	TCP	Any Any	Any 80	Deny	
No_FTP_access		Any Any	Any 21	Deny	
Default	Any	Any	Any	Allow	

To remove a rule, click the button.

Rules are matched from top to the bottom. If a connection matches any one of the upper rules, the matching process will stop. If none of the rules match the connection, the **Default** rule will be applied.

The **Default** rule is **Allow** for Outbound, Inbound and Internal Network access.

Tip

If the default inbound rule is set to **Allow** for NAT-enabled WANs, no inbound Allow firewall rules will be required for inbound port forwarding and inbound NAT mapping rules. However, if the default inbound rule is set as **Deny**, a corresponding Allow firewall rule will be required.

Intrusion Detection and DoS Prevention

Intrusion Detection and DoS Prevention

Intrusion Detection and DoS Prevention Enable

The Balance can detect and prevent intrusions and denial-of-service (DoS) attacks from the Internet. To turn on this feature, click , check the **Enable** check box for the **Intrusion Detection and DoS Prevention**, and press the **Save** button.

When this feature is enabled, the Balance will detect and prevent the following kinds of intrusions and denial-of-service attacks.

- Port scan
 - o NMAP FIN/URG/PSH
 - o Xmas tree
 - o Another Xmas tree
 - o Null scan
 - o SYN/RST
 - o SYN/FIN

- SYN flood prevention
- Ping flood attack prevention

13.11.2 Content Blocking

Application Blocking ?

Please Select Application... +

Web Blocking ?

Preset Category			
<input type="radio"/> High <input type="radio"/> Moderate <input type="radio"/> Low <input checked="" type="radio"/> Custom	<input type="checkbox"/> Adware <input type="checkbox"/> Dating <input type="checkbox"/> P2P/File sharing <input type="checkbox"/> Malware <input type="checkbox"/> Social Networking <input type="checkbox"/> Violence	<input type="checkbox"/> Aggressive <input type="checkbox"/> Drugs <input type="checkbox"/> Gambling <input checked="" type="checkbox"/> Pornography <input type="checkbox"/> Contraband <input type="checkbox"/> Weapons	<input type="checkbox"/> Audio-Video <input type="checkbox"/> File Hosting <input type="checkbox"/> Games <input checked="" type="checkbox"/> Proxy/Anonymizer <input type="checkbox"/> Update Sites

Content Filtering Database Auto Update ?	<input type="checkbox"/>
---	--------------------------

Customized Domains ?
<input style="width: 90%;" type="text"/> +

Exempted Domains from Web Blocking ?
<input style="width: 90%;" type="text"/> +

Exempted User Groups ?

Manager	<input type="checkbox"/> Exempt
Staff	<input type="checkbox"/> Exempt
Guest	<input type="checkbox"/> Exempt

Exempted Subnets ?

Network	Subnet Mask	
<input style="width: 95%;" type="text"/>	255.255.255.0 (/24)	+

URL Logging

Enable	<input type="checkbox"/>
Log Server Host	<input style="width: 80%;" type="text"/> Port: 514

Application Blocking

Choose applications to be blocked from LAN/PPTP/PepVPN peer clients' access, except for those on the Exempted User Groups or Exempted Subnets defined below.

Web Blocking

Defines website domain names to be blocked from LAN/PPTP/PepVPN peer clients' access except for those on the Exempted User Groups or Exempted Subnets defined below.

If "foobar.com" is entered, any web site with a host name ending in foobar.com will be blocked,

e.g. www.foobar.com, foobar.com, etc. However, "myfoobar.com" will not be blocked.

You may enter the wild card ".*" at the end of a domain name to block any web site with a host name having the domain name in the middle. If you enter "foobar.*", then "www.foobar.com", "www.foobar.co.jp", or "foobar.co.uk" will be blocked. Placing the wild card in any other position is not supported.

The device will inspect and look for blocked domain names on all HTTP and HTTPS traffic.

Customized Domains

Enter an appropriate website address, and the Peplink Balance will block and disallow LAN/PPTP/SpeedFusion™ peer clients to access these websites. Exceptions can be added using the instructions in **Sections 21.2.1.4** and **21.2.1.5**.

You may enter the wild card ".*" at the end of a domain name to block any web site with a host name having the domain name in the middle. For example, If you enter "foobar.*," then "www.foobar.com," "www.foobar.co.jp," or "foobar.co.uk" will be blocked. Placing the wild card in any other position is not supported.

The Peplink Balance will inspect and look for blocked domain names on all HTTP traffic. Secure web (HTTPS) traffic is not supported.

Exempted User Groups

Check and select pre-defined user group(s) who can be exempted from the access blocking rules. User groups can be defined at **QoS>User Groups** section. Please refer to **Section 20.1** for details.

Exempted Subnets

With the subnet defined in the field, clients on the particular subnet(s) can be exempted from the access blocking rules.

URL Logging

Click **enable**, and then enter the ip address and port (if applicable) where your remote syslog server is located.

13.12 Routing Protocols

13.12.1 OSPF & RIPv2

The Peplink Balance supports OSPF and RIPv2 dynamic routing protocols. Click the **Network** tab from the top bar, and then click the **Routing Protocols > OSPF & RIPv2** item on the sidebar to reach the following menu:

OSPF		
Router ID	LAN IP Address	
Area		
0.0.0.0	Untagged LAN (192.168.112.1/24), WAN 4 (192.168.254.10/24)	
<input type="button" value="Add"/>		
RIPv2		
No RIPv2 Defined.		
OSPF & RIPv2 Route Advertisement		
PepVPN Route Isolation	<input type="checkbox"/> Enable	
Network Advertising	--- <input type="button" value="+"/>	All LAN/VLAN networks will be advertised when no network advertising is chosen.
Static Route Advertising	<input checked="" type="checkbox"/> Enable	
	Excluded Networks	Subnet Mask
	<input type="text"/>	255.255.255.0 (/24) <input type="button" value="+"/>
<input type="button" value="Save"/>		

OSPF	
Router ID	This field determines the ID of the router. By default, this is specified as the WAN IP address. If you want to specify your own ID, enter it into the Custom field.
Area	This is an overview of the OSPF areas that you have defined. Clicking on the name under Area allows you to configure the connection. To define a new area, click Add. To delete an existing area, click on the .

OSPF settings
✕

Area ID	<input type="text" value="0.0.0.0"/>
Link Type	<input checked="" type="radio"/> Broadcast <input type="radio"/> Point-to-Point
Authentication	None ▾
Interfaces ?	<input checked="" type="checkbox"/> Untagged LAN (192.168.112.1/24) <input type="checkbox"/> Management VLAN (10.0.2.1/24) <input type="checkbox"/> jamestest (10.22.37.1/24) <input type="checkbox"/> WAN 1 <input type="checkbox"/> WAN 2 <input type="checkbox"/> WAN 3 <input checked="" type="checkbox"/> WAN 4 (192.168.254.10/24) <input type="checkbox"/> WAN 5

OSPF Settings	
Area ID	Assign a name to be applied to this group. Machines linked to this group will send and receive related OSPF packets, while unlinked machines will ignore them.
Link Type	Choose the type of network that this area will use.
Authentication	If an authentication method is used, select one from this drop-down menu. Available options are MD5 and Text . Authentication key(s) may be input next to the drop-down menu after selecting an authentication method.
Interfaces	Select the interface(s) that this area will use to listen to and deliver OSPF packets.

To access RIPv2 settings, click on  .

RIPv2 settings ✕

Authentication	None ▾
Interfaces	<input type="checkbox"/> Untagged LAN (192.168.112.1/24) <input type="checkbox"/> Management VLAN (10.0.2.1/24) <input type="checkbox"/> jamestest (10.22.37.1/24) <input type="checkbox"/> WAN 1 <input type="checkbox"/> WAN 2 <input type="checkbox"/> WAN 3 <input type="checkbox"/> WAN 4 (192.168.254.10/24) <input type="checkbox"/> WAN 5

RIPv2 Settings

Authentication	If an authentication method is used, select one from this drop-down menu. Available options are MD5 and Text . Authentication key(s) may be input next to the drop-down menu after selecting an authentication method.
Interfaces	Select the interface(s) that this area will use to listen to and deliver RIPv2 packets.

OSPF & RIPv2 Route Advertisement

PepVPN Route Isolation ?	<input type="checkbox"/> Enable						
Network Advertising ?	<div style="display: flex; align-items: center;"> <div style="flex-grow: 1;">---</div> <div style="margin-left: 10px;">+</div> </div> <small>All LAN/VLAN networks will be advertised when no network advertising is chosen.</small>						
Static Route Advertising ?	<input checked="" type="checkbox"/> Enable <table border="1" style="width: 100%; border-collapse: collapse;"> <thead> <tr> <th style="width: 60%;">Excluded Networks</th> <th style="width: 20%;">Subnet Mask</th> <th style="width: 20%;"></th> </tr> </thead> <tbody> <tr> <td style="height: 20px;"></td> <td>255.255.255.0 (/24) ▾</td> <td style="text-align: center;">+</td> </tr> </tbody> </table>	Excluded Networks	Subnet Mask			255.255.255.0 (/24) ▾	+
Excluded Networks	Subnet Mask						
	255.255.255.0 (/24) ▾	+					

OSPF & RIPv2 Route Advertisement

PepVPN Route Isolation	Isolate PepVPN peers from each other. Received PepVPN routes will not be forwarded to other PepVPN peers to reduce bandwidth consumption..
Network Advertising	Networks to be advertised over OSPF & RIPv2. If no network is selected, all LAN / VLAN networks will be advertised by default.
Static Route Advertising	Enabling OSPF & RIPv2 Route Advertisement allows it to advertise LAN static routes over OSPF & RIPv2. Static routes on the Excluded Networks table will not be advertised.

13.12.2 BGP

Click the **Network** tab along the top bar, and then click the **BGP** item on the sidebar to configure BGP.

BGP	AS	Neighbors	
Uplink	64520	172.16.51.1	
<input type="button" value="Add"/>			

Click the "**x**" to delete a BGP profile.
Click "**Add**" to create a new BGP profile.

BGP Profile ✕

BGP Profile

Profile Name

Enable

Interface WAN ▾

Router ID
 WAN IP Address
 Custom:

Autonomous System

Neighbor	IP Address	Autonomous System	Multihop / TTL	Password	AS-Path Prepending	
	<input type="text"/>	<input type="text"/>	<input type="text"/>	disable	<input type="text"/>	<input type="text"/>

Hold Time

Next Hop Self

iBGP Local Preference

BFD Enable



BGP	
Name	This field specifies the name that represents this profile.
Enable	When this box is checked, this BGP profile will be enabled. If it is left unchecked, it will be disabled.
Interface	The interface in which the BGP neighbor is located.
Autonomous System	The Autonomous System Number (ASN) assigned to this profile.
Neighbor	BGP Neighbors and their details.
IP address	The IP address of the Neighbor.
Autonomous	The Neighbor's ASN.

System	
Multihop/TTL	This field determines the Time-to-live (TTL) of BGP packets. Leave this field blank if the BGP neighbor is directly connected, otherwise you must specify a TTL value. This option should be used if the configured Neighbor's IP address does not match the selected Interface's network subnets. The TTL value must be between 2 to 255.
Password	(Optional) Assign a password for MD5 authentication of BGP sessions.
AS-Path Prepending:	AS path to be prepended to the routes received from this Neighbor. Values must be ASN and separated by commas. For example: inputting "64530,64531" will prepend "64530, 64531" to received routes.
Hold Time	Wait time in seconds for a keepalive message from a Neighbor before considering the BGP connection as stalled. The value must be either 0 (infinite hold time) or between 3 and 65535 inclusively. Default: 240
Next Hop Self	Enable this option to advertise your own source address as the next hop when propagating routes.
iBGP Local Preference	This is the metric advertised to iBGP Neighbors to indicate the preference for external routes. The value must be between 0 to 4294967295 inclusively. Default: 100
BFD	Enable this option to add Bidirectional Forwarding Detection for path failure. All directly connected Neighbors that use the same physical interface share the same BFD settings. All multihop Neighbors share the same multihop BFD settings. You can configure BFD settings in the BGP profile listing page after this option is enabled.

Route Advertisement			
Network Advertising	?	---	+
Static Route Advertising	?	<input checked="" type="checkbox"/> Enable	
		Excluded Networks	Subnet Mask
		<input type="text"/>	255.255.255.0 (/24) <input type="button" value="+"/> <input type="button" value="v"/>
Custom Route Advertising	?	Networks	Subnet Mask
		<input type="text"/>	255.255.255.0 (/24) <input type="button" value="+"/> <input type="button" value="v"/>
Advertise OSPF Route	?	<input type="checkbox"/>	
Set Community	?	Community	Route Prefix
		<input type="text"/>	<input type="text"/> <input type="button" value="+"/> <input type="button" value="v"/>

Route Advertisement	
Network Advertising	Select the Networks that will be advertised to the BGP Neighbor.
Static Route Advertising	Enable this option to advertise static LAN routes. Static routes that match the Excluded Networks table will not be advertised.

Custom Route Advertising	Additional routes to be advertised to the BGP Neighbor.
Advertise OSPF Route	When this box is checked, every learnt OSPF route will be advertised.
Set Community	<p>Assign a prefix to a Community</p> <p>Community: Two numbers in new-format. e.g. 65000:21344</p> <p>Well-known communities: no-export 65535:65281 no-advertise 65535:65282 no-export-subconfed 65535:65283 no-peer 65535:65284</p> <p>Route Prefix: Comma separated networks. e.g. 172.168.1.0/24,192.168.1.0/28</p>

Route Import			
Filter Mode		Accept ▼	
Restricted Networks	Network	Subnet Mask	Exact Match
		255.255.255.0 (/24) ▼	<input type="checkbox"/>
			

Route Import Settings	
Filter Mode	<p>This field allows for the selection of the filter mode for route import.</p> <p>None: All BGP routes will be accepted.</p> <p>Accept: Routes in "Restricted Networks" will be accepted, routes not in the list will be rejected.</p> <p>Reject: Routes in "Restricted Networks" will be rejected, routes not in the list will be accepted.</p>
Restricted Networks	<p>This field specifies the network(s) in the "route import" entry.</p> <p>Exact Match: When this box is checked, only routes with the same Network and Subnet Mask will be filtered.</p> <p>Otherwise, routes within the Networks and Subnets will be filtered.</p>

Route Export			
Filter Mode	Accept ▼		
Restricted Networks	Network	Subnet Mask	Exact Match
		255.255.255.0 (/24) ▼	<input type="checkbox"/>
Export to other BGP Profile	<input type="checkbox"/>		
Export to OSPF	<input type="checkbox"/>		

Filter Mode	<p>This field allows for the selection of the filter mode for route export.</p> <p>None: All BGP routes will be accepted.</p> <p>Accept: Routes in "Restricted Networks" will be accepted, routes not in the list will be rejected.</p> <p>Reject: Routes in "Restricted Networks" will be rejected, routes not in the list will be accepted.</p>
Restricted Networks	<p>This field specifies the network(s) in the "route export" entry.</p> <p>Exact Match: When this box is checked, only routes with the same Network and Subnet Mask will be filtered.</p> <p>Otherwise, routes within the Networks and Subnets will be filtered.</p>
Export to other BGP Profile	When this box is checked, routes learnt from this BGP profile will be exported to other BGP profiles.
Export to OSPF	When this box is checked, routes learnt from this BGP profile will be exported to the OSPF routing protocol.

13.13 Remote User Access

A remote-access VPN connection allows an individual user to connect to a private business network from a remote location using a laptop or desktop computer connected to the Internet. Networks routed by a Peplink router can be remotely accessed via OpenVPN, L2TP with IPsec or PPTP. To configure this feature, navigate to **Network > Remote User Access** and choose the required VPN type.

13.13.1 L2TP with IPsec

Remote User Access Settings	
Enable	<input checked="" type="checkbox"/>
VPN Type	<input checked="" type="radio"/> L2TP with IPsec <input type="radio"/> PPTP <input type="radio"/> OpenVPN
Pre-shared Key	<input type="text"/> <input checked="" type="checkbox"/> Hide Characters

L2TP with IPsec Remote User Access Settings	
Pre-shared Key	Enter your pre shared key in the text field. Please note that remote devices will need this pre-shared key to access the Balance.
Listen On	This setting is for specifying the WAN IP addresses that allow remote user access.
Disable Weak Ciphers	Click the button to show and enable this option. When checked, weak ciphers such as 3DES will be disabled.

Continue to configure the authentication method.

13.13.2 OpenVPN

Remote User Access Settings	
Enable	<input checked="" type="checkbox"/>
VPN Type	<input type="radio"/> L2TP with IPsec <input type="radio"/> PPTP <input checked="" type="radio"/> OpenVPN <small>You can obtain the OpenVPN client profile from the status page.</small>

Select OpenVPN and continue to configure the authentication method.

The OpenVPN Client profile can be downloaded from the **Status > device** page after the configuration has been saved.

OpenVPN Client Profile	<input checked="" type="checkbox"/> Route all traffic Split tunnel
------------------------	--

You have a choice between 2 different OpenVPN Client profiles:

Option 1: "Route all traffic" profile

Using this profile, VPN clients will send all the traffic through the OpenVPN tunnel

Option 2: "Split tunnel" profile

Using this profile, VPN clients will ONLY send those traffic designated to the untagged LAN and VLAN segment through the OpenVPN tunnel.

13.13.3 PPTP

Remote User Access Settings	
Enable	<input checked="" type="checkbox"/>
VPN Type	<input type="radio"/> L2TP with IPsec <input checked="" type="radio"/> PPTP <input type="radio"/> OpenVPN

No additional configuration required.

The Point-to-Point Tunneling Protocol (PPTP) is an obsolete method for implementing virtual private networks. PPTP has many well known security issues
Continue to configure authentication methods.

13.13.4 Authentication Methods

Connect to Network	? Untagged LAN ▼						
Authentication	Local User Accounts ▼						
User Accounts	<table border="1"> <thead> <tr> <th>Username</th> <th>Password</th> <th></th> </tr> </thead> <tbody> <tr> <td></td> <td></td> <td></td> </tr> </tbody> </table>	Username	Password				
Username	Password						

Authentication Method	
Connect to Network	Select the VLAN network for remote users to enable remote user access on.
Authentication	Determine the method of authenticating remote users

User accounts:

This setting allows you to define the Remote User Accounts.
Click Add to input username and password to create an account. After adding the user accounts, you can click on a username to edit the account password.

Note:

The username must contain lowercase letters, numerics, underscore(_), dash(-), at sign(@), and period(.) only.

The password must be between 8 and 12 characters long.

LDAP Server:

Connect to Network	? Untagged LAN ▾
Authentication	LDAP Server ▾
LDAP Server	<input type="text"/> Port <input type="text" value="389"/> Default <input type="checkbox"/> Use DN/Password to bind to LDAP Server
Base DN	<input type="text"/>
Base Filter	<input type="text"/>

Enter the matching LDAP server details to allow for LDAP server authentication.

Radius Server:

Authentication	RADIUS Server ▾
Auth Protocol	MS-CHAP v2 ▾
Auth Server	<input type="text"/> Port <input type="text" value="1812"/> Default
Auth Server Secret	<input type="text"/> <input checked="" type="checkbox"/> Hide Characters
Accounting Server	<input type="text"/> Port <input type="text" value="1813"/> Default
Accounting Server Secret	<input type="text"/> <input checked="" type="checkbox"/> Hide Characters

Enter the matching Radius server details to allow for Radius server authentication.

Active Directory:

Connect to Network	? Untagged LAN ▾
Authentication	Active Directory ▾
Server Hostname	<input type="text"/>
Domain	<input type="text"/>
Admin Username	<input type="text"/>
Admin Password	<input type="text"/> <input checked="" type="checkbox"/> Hide Characters

Enter the matching Active Directory details to allow for Active Directory server authentication.

13.14 Misc. Settings

13.14.1 High Availability

Peplink Balance supports high availability (HA) configurations via an open standard virtual router redundancy protocol (VRRP, RFC 3768).

In an HA configuration, two same-model Peplink Balance units provide redundancy and failover

in a master-slave arrangement. In the event that the master unit is down, the slave unit becomes active.

High availability will be disabled automatically where there is a drop-in connection configured on a LAN bypass port.

The following diagram illustrates an HA configuration with two Peplink Balance units and two Internet connections:

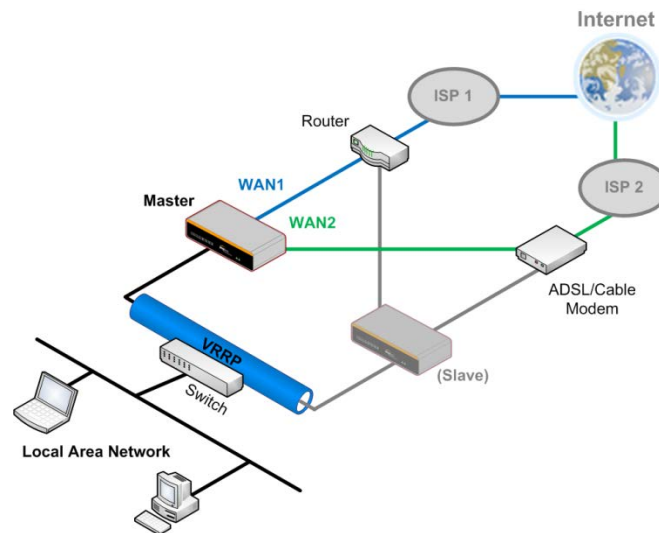

In the diagram, the WAN ports of each Peplink Balance unit connect to the router and to the modem. Both Peplink Balance units connect to the same LAN switch via a LAN port.

An elaboration on the technical details of the implementation of virtual router redundancy protocol (VRRP, RFC 3768) by the Balance follows:

- In an HA configuration, the two Peplink Balance units communicate with each other using VRRP over the LAN.
- The two Peplink Balance units broadcast heartbeat signals to the LAN at a frequency of one heartbeat signal per second.
- In the event that no heartbeat signal from the master Peplink Balance unit is received in 3 seconds (or longer) since the last heartbeat signal, the slave Peplink Balance unit becomes active.
- The slave Peplink Balance unit initiates the WAN connections and binds to a previously configured LAN IP address.
- At a subsequent point when the master Peplink Balance unit recovers, it will once again become active.

You can configure high availability at **Network>Misc. Settings>High Availability**.

Interface for Master Router

Interface for Slave Router

High Availability	
Enable	<input checked="" type="checkbox"/>
Group Number	5
Preferred Role	<input checked="" type="radio"/> Master <input type="radio"/> Slave
Resume Master Role Upon Recovery	<input checked="" type="checkbox"/>
Virtual IP	
LAN Administration IP	192.168.1.1
Subnet Mask	255.255.255.0

High Availability	
Enable	<input checked="" type="checkbox"/>
Group Number	5
Preferred Role	<input type="radio"/> Master <input checked="" type="radio"/> Slave
Configuration Sync.	<input type="checkbox"/> Master Serial Number: 5454- 5454 - 5454
Virtual IP	
LAN Administration IP	192.168.1.1
Subnet Mask	255.255.255.0

High Availability	
Enable	Checking this box specifies that the Peplink Balance unit is part of a high availability configuration.
Group Number	This number identifies a pair of Peplink Balance units operating in a high availability configuration. The two Peplink Balance units in the pair must have the same Group Number value.
Preferred Role	This setting specifies whether the Peplink Balance unit operates in master or slave mode. Click the corresponding radio button to set the role of the unit. One of the units in the pair must be configured as the master, and the other unit must be configured as the slave.
Resume Master Role Upon Recovery	This option is displayed when Master mode is selected in Preferred Role . If this option is enabled, once the device has recovered from an outage, it will take over and resume its Master role from the slave unit.
Configuration Sync.	This option is displayed when Slave mode is selected in Preferred Role . If this option is enabled and the Master Serial Number entered matches with the actual master unit's, the master unit will automatically transfer the configuration to this unit. Please make sure the LAN IP Address and the Subnet Mask fields are set correctly in the LAN settings page. You can refer to the Event Log for the configuration synchronization status.
Master Serial Number	If Configuration Sync. is checked, the serial number of the master unit is required here for the feature to work properly.
Virtual IP	The HA pair must share the same Virtual IP . The Virtual IP and the LAN Administration IP must be under the same network.
LAN Administration IP	This setting specifies a LAN IP address to be used for accessing administration functionality. This address should be unique within the LAN.
Subnet Mask	This setting specifies the subnet mask of the LAN.

Important Note

For Balance routers in NAT mode, the virtual IP (VIP) should be set as the default gateway for all hosts sitting on the LAN segment. For example, a firewall sitting behind the Balance should set its default gateway as the virtual IP instead of the IP of the master Balance.

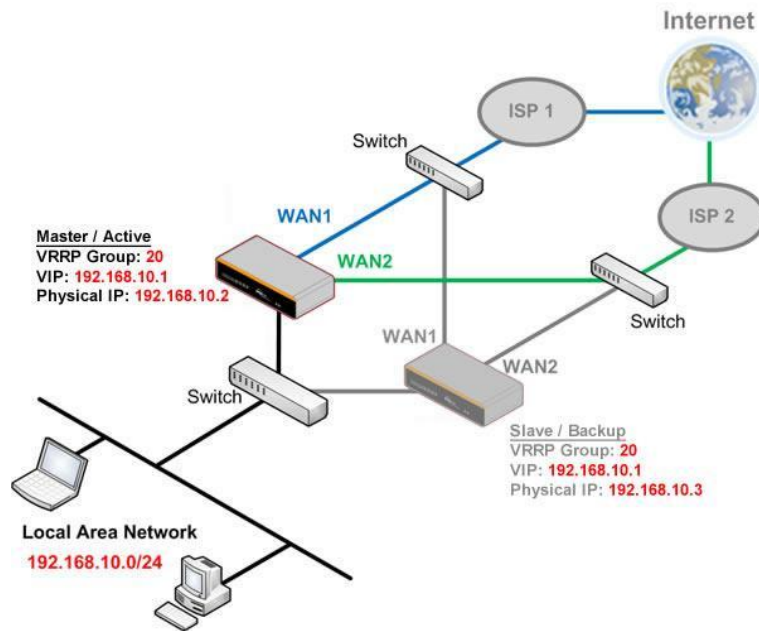

In drop-in mode, no other configuration needs to be set.

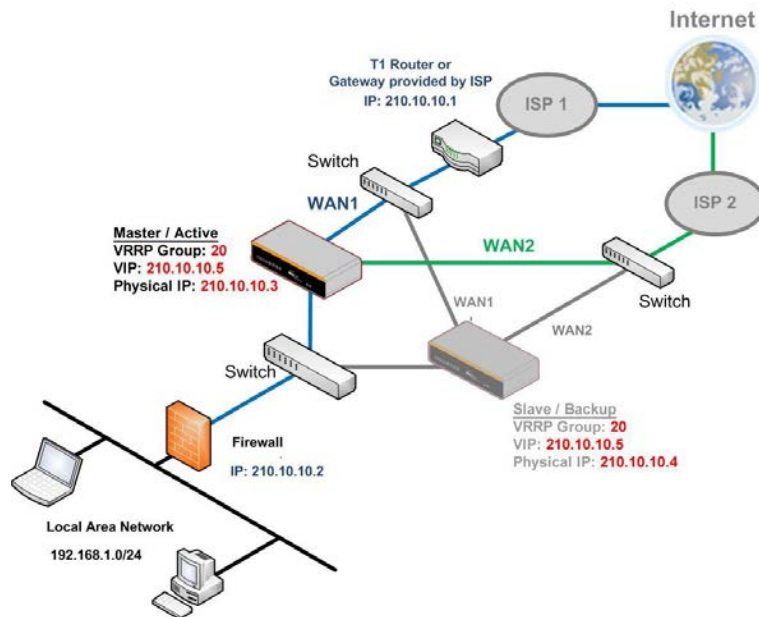

Please note that the drop-in WAN cannot be configured as a LAN bypass port while it is configured for high availability.

13.14.2 Certificate Manager

Certificate		
VPN Certificate	No Certificate	
Web Admin SSL Certificate	Default Certificate is in use	
Captive Portal SSL Certificate	Default Certificate is in use	
MediaFast Root CA Certificate	Default Certificate is in use	
OpenVPN Root CA Certificate	Default Certificate is in use	

ContentHub Certificate
No Certificates defined
<input type="button" value="Add Certificate"/>

Wi-Fi WAN Client Certificate
No Certificates defined
<input type="button" value="Add Certificate"/>

Wi-Fi WAN CA Certificate
No Certificates defined
<input type="button" value="Add Certificate"/>



This section allows you to assign certificates for the local VPN, OpenVPN, Captive Portal, Mediafast, ContentHub, Wi-Fi WAN (Client and CA) and web admin SSL for extra security.

Read the following knowledgebase article for full instructions on how to create and import a self-signed certificate:

<https://forum.peplink.com/t/how-to-create-a-self-signed-certificate-and-import-it-to-a-peplink-product/>

13.14.3 Service Forwarding

Service forwarding settings are located at **Network>Misc. Settings>Service Forwarding**.

SMTP Forwarding Setup 	
SMTP Forwarding	<input type="checkbox"/> Enable
Web Proxy Forwarding Setup 	
Web Proxy Forwarding	<input type="checkbox"/> Enable
DNS Forwarding Setup 	
Forward Outgoing DNS Requests to Local DNS Proxy	<input type="checkbox"/> Enable
Custom Service Forwarding Setup	
Custom Service Forwarding	<input type="checkbox"/> Enable

Service Forwarding	
SMTP Forwarding	When this option is enabled, all outgoing SMTP connections destined for any host at TCP port 25 will be intercepted. These connections will be redirected to a specified SMTP server and port number. SMTP server settings for each WAN can be specified after selecting Enable .
Web Proxy Forwarding	When this option is enabled, all outgoing connections destined for the proxy server specified in Web Proxy Interception Settings will be intercepted. These connections will be redirected to a specified web proxy server and port number. Web proxy interception settings and proxy server settings for each WAN can be specified after selecting Enable .
DNS Forwarding	When this option is enabled, all outgoing DNS lookups will be intercepted and redirected to the built-in DNS name server. If any LAN device is using the DNS name servers of a WAN connection, you may want to enable this option to enhance the DNS availability without modifying the DNS server setting of the clients. The built-in DNS name server will distribute DNS lookups to corresponding DNS servers of all available WAN connections. In this case, DNS service will not be interrupted, even if any WAN connection is down.
Custom Service Forwarding	When custom service forwarding is enabled, outgoing traffic with the specified TCP port will be forwarded to a local or remote server by defining its IP address and port number.

SMTP Forwarding

Some ISPs require their users to send e-mails via the ISP's SMTP server. All outgoing SMTP connections are blocked except those connecting to the ISP's. The Peplink Balance supports the interception and redirection of all outgoing SMTP connections (destined for TCP port 25) via a WAN connection to the WAN's corresponding SMTP server.

SMTP Forwarding Setup			
SMTP Forwarding		<input checked="" type="checkbox"/> Enable	
Connection	Enable Forwarding?	SMTP Server	SMTP Port
WAN 1	<input type="checkbox"/>		
WAN 2	<input checked="" type="checkbox"/>	22.2.2.2	25
WAN 3	<input checked="" type="checkbox"/>	33.3.3.2	25
WAN 4	<input type="checkbox"/>		

To enable the feature, select **Enable** under **SMTP Forwarding Setup**. Check **Enable Forwarding** for the WAN connection(s) that needs forwarding. Under **SMTP Server**, enter the ISP's e-mail server host name or IP address. Under **SMTP Port**, enter the TCP port number for each WAN.

The Peplink Balance will intercept SMTP connections. Choose a WAN port according to the outbound policy, and then forward the connection to the SMTP server, if the chosen WAN has enabled forwarding. If the forwarding is disabled for a WAN connection, SMTP connections for the WAN will be simply be forwarded to the connection's original destination.

Note

If you want to route all SMTP connections only to particular WAN connection(s), you should create a custom rule in outbound policy (see **Section 16.1**).

Web Proxy Forwarding

Web Proxy Forwarding Setup			
Web Proxy Forwarding		<input checked="" type="checkbox"/> Enable	
Web Proxy Interception Settings			
Proxy Server		IP Address <input type="text" value="123.123.11.22"/>	Port <input type="text" value="8080"/>
<small>(Current settings in users' browser)</small>			
Connection	Enable Forwarding?	Proxy Server IP Address : Port	
WAN 1	<input type="checkbox"/>		
WAN 2	<input checked="" type="checkbox"/>	22.2.2.2	: 8765
WAN 3	<input checked="" type="checkbox"/>	33.3.3.2	: 8080
WAN 4	<input type="checkbox"/>		

When this feature is enabled, the Peplink Balance will intercept all outgoing connections destined for the proxy server specified in **Web Proxy Server Interception Settings**. Then it will choose a WAN connection according to the outbound policy and forward the connection to the specified web proxy server and port number. Redirected server settings for each WAN can be set here. If forwarding is disabled for a WAN, then web proxy connections for that WAN will simply be forwarded to the connection's original destination.

DNS Forwarding

DNS Forwarding Setup ?	
Forward Outgoing DNS Requests to Local DNS Proxy	<input checked="" type="checkbox"/> Enable

When DNS forwarding is enabled, all clients' outgoing DNS requests will also be intercepted and forwarded to the built-in DNS proxy server.

Custom Service Forwarding

Custom Service Forwarding Setup			
Custom Service Forwarding	<input checked="" type="checkbox"/> Enable		
Settings	TCP Port	Server IP Address	Server Port
	<input type="text"/>	<input type="text"/>	<input type="text"/> +

After clicking the **enable** checkbox, enter your TCP port for traffic heading to the router, and then specify the IP Address and Port of the server you wish to forward to the service to.

13.14.4 Service Passthrough

Service passthrough settings can be found at **Network>Misc. Settings>Service Passthrough**.

Service Passthrough Support	
SIP	<input checked="" type="radio"/> Standard Mode <input type="radio"/> Compatibility Mode <input checked="" type="checkbox"/> Define custom signal ports 1. <input type="text"/> 2. <input type="text"/> 3. <input type="text"/>
H.323	<input checked="" type="checkbox"/> Enable
FTP	<input checked="" type="checkbox"/> Enable <input checked="" type="checkbox"/> Define custom control ports 1. <input type="text"/> 2. <input type="text"/> 3. <input type="text"/>
TFTP	<input checked="" type="checkbox"/> Enable
IPsec NAT-T	<input checked="" type="checkbox"/> Enable <input checked="" type="checkbox"/> Define custom ports 1. <input type="text"/> 2. <input type="text"/> 3. <input type="text"/> <input checked="" type="checkbox"/> Route IPsec Site-to-Site VPN via <input type="text" value="WAN 1"/>

(Registered trademarks are copyrighted by their respective owner)

Some Internet services need to be specially handled in a multi-WAN environment. The Peplink Balance can handle these services such that Internet applications do not notice it is behind a multi-WAN router. Settings for service passthrough support are available here.

Service Passthrough Support	
SIP	<p>Session initiation protocol, aka SIP, is a voice-over-IP protocol. The Peplink Balance can act as a SIP application layer gateway (ALG) which binds connections for the same SIP session to the same WAN connection and translate IP address in the SIP packets correctly in NAT mode. Such passthrough support is always enabled and there are two modes for selection: Standard Mode and Compatibility Mode.</p> <p>If your SIP server's signal port number is non-standard, you can check the box Define custom signal ports and input the port numbers to the text boxes.</p>
H.323	<p>With this option enabled, protocols that provide audio-visual communication sessions will be defined on any packet network and passthrough the Balance.</p>
FTP	<p>FTP sessions consist of two TCP connections; one for control and one for data. In a multi-WAN situation, they must be routed to the same WAN connection. Otherwise, problems will arise in transferring files. By default, the Peplink Balance monitors TCP control connections on port 21 for any FTP connections and binds TCP connections of the same FTP session to the same WAN.</p> <p>If you have an FTP server listening on a port number other than 21, you can check Define custom control ports and enter the port numbers in the text boxes.</p>
TFTP	<p>The Peplink Balance monitors outgoing TFTP connections and routes any incoming TFTP data packets back to the client. Select Enable if you want to enable TFTP passthrough support.</p>
IPsec NAT-T	<p>This field is for enabling the support of IPsec NAT-T passthrough. UDP ports 500, 4500, and 10000 are monitored by default.</p> <p>You may add more custom data ports that your IPsec system uses by checking Define custom ports. If the VPN contains IPsec site-to-site VPN traffic, check Route IPsec Site-to-Site VPN and choose the WAN connection to route the traffic to.</p>

13.14.5 NTP Server

Peplink routers can now serve as a local NTP server. Upon start up, it is now able to provide connected devices with the accurate time, precise UTC from either an external NTP server or via GPS and ensuring that connected devices always receive the correct time.

NTP Server setting can be found via: **Network>Misc. Settings>NTP Server**

NTP Server	
Enable	<input type="checkbox"/>
<input type="button" value="Save"/>	

Time Settings can be found at **System>Time>Time Settings**

Time Settings	
Time Zone	(GMT) Casablanca <input type="checkbox"/> Show all
Time Sync	Time Server
Time Server	0.peplink.pool.ntp.org
<input type="button" value="Save"/>	

13.14.6 Grouped Networks

Grouped Networks		
Name	Networks	
		<input type="button" value="Add Group"/>

Using “Grouped Networks” you can group and name a range of IP addresses, which can then be used to define firewall rules or outbound policies.

Start by clicking on “add group” then fill in the appropriate field.

In this example we’ll create a group “accounting”

Click save when you have finished adding the required networks.

Grouped Networks			
Name	Accounting		
Networks	Network	Subnet Mask	
	192.168.50.192	255.255.255.224 (/27)	✖
		255.255.255.255 (/32)	+

The grouped network “accounting” can now be used to configure a group policy or firewall rule.

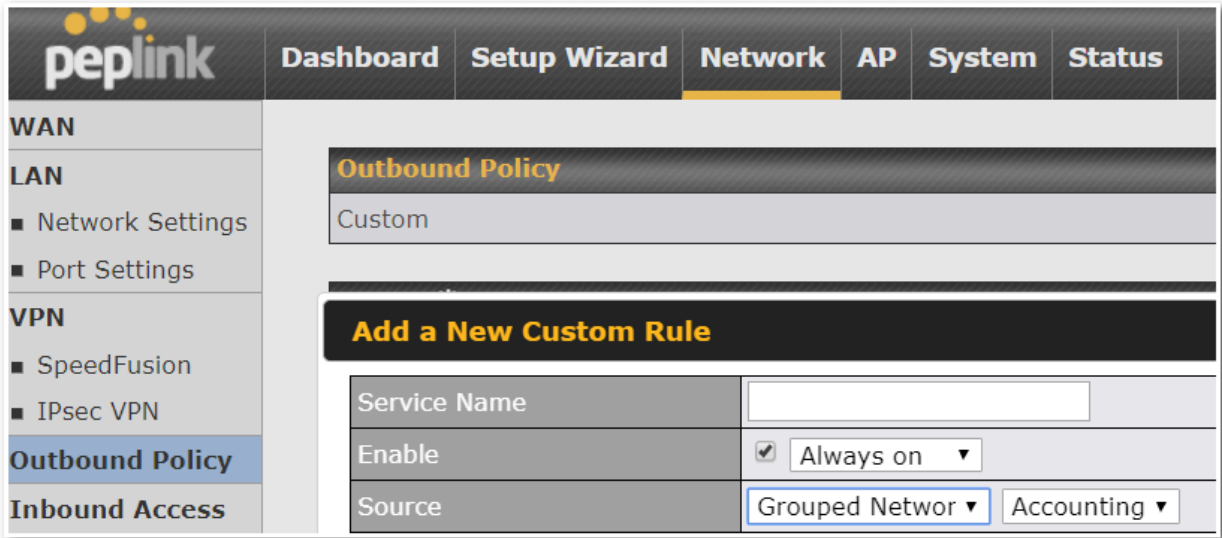

13.14.7 Remote SIM Management

Remote SIM management is accessible via **Network > Misc Settings > Remote SIM Management**. By default, this feature is disabled.

Please note that a limited number of Pepwave routers support the SIM Injector, may refer to the link: <https://www.peplink.com/products/sim-injector/> or Appendix C for more details on FusionSIM Manual.

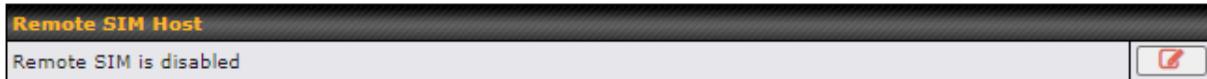

Remote SIM Host Settings

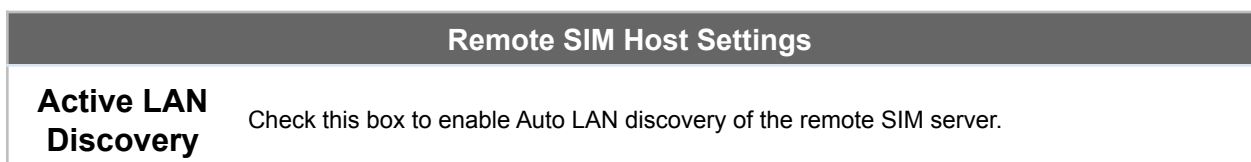
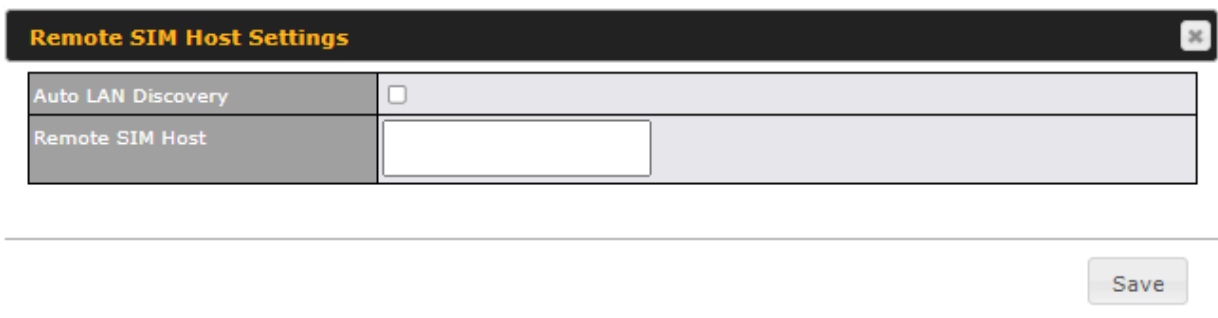

Remote SIM Host

Enter the public IP address of the SIM Injector. If you enter IP addresses here, it is not necessary to tick the **“Auto LAN Discovery”** box above.

Remote SIM Host
 192.168.1.10 

Remote SIM Management	Server	Slot
No Remote SIM Defined.		
Add Remote SIM		

You may define the Remote SIM information by clicking the **“Add Remote SIM”**. Here, you can enable **Data Roaming** and **custom APN** for your SIM cards.

Add Remote SIM 

Remote SIM	
SIM Server	New SIM Server... ▼
SIM Server - Serial Number	<input type="text"/>
SIM Server - Name	Optional <input type="text"/>
SIM Slot	1 ▼
SIM Slot - Name	Optional <input type="text"/>
Data Roaming	<input type="checkbox"/>
Operator Settings (for LTE/HSPA/EDGE/GPRS only) 	<input checked="" type="radio"/> Auto <input type="radio"/> Custom Mobile Operator Settings
SIM PIN (Optional)	<input type="text"/> <input type="text"/> (Confirm)

[Save](#)

Add Remote SIM Settings

SIM Server	Add a new SIM Server
SIM Server - Serial Number	Enter the serial number of SIM Server
SIM Server - Name	This optional field allows you define a name for the SIM Server
SIM Slot	Click the drop-down menu and choose which SIM slot you want to connect.
SIM Slot - Name	This optional field allows you define a name for the SIM slot.

<p>Data Roaming</p>	<p>Enables data roaming on this particular SIM card.</p>
<p>Operator Settings (for LTE//HSPA/EDGE/GPRS Only)</p>	<p>This setting allows you to configure the APN settings of your connection. If Auto is selected, the mobile operator should be detected automatically. The connected device will be configured and connection will be made automatically. If there is any difficulty in making a connection, you may select Custom to enter your carrier's APN, Username and Password settings manually. The correct values can be obtained from your carrier. The default and recommended setting is Auto.</p>

13.14.8 SIM Toolkit

The SIM Toolkit can be found via **Networks > Misc Settings > SIM Toolkit**. This supports two functionalities, USSD and SMS.

USSD

Unstructured Supplementary Service Data (USSD) is a protocol used by mobile phones to communicate with their service provider's computers. One of the most common uses is to query the available balance.

SIM Status	
WAN Connection	Cellular
SIM Card	1
IMSI	XXXXXXXXXXXX
Tool	USSD

USSD	
USSD Code	<input type="text"/> <input type="button" value="Submit"/>

Enter your USSD code under the **USSD Code** text field and click **Submit**.

SIM Status	
WAN Connection	Cellular
SIM Card	1
IMSI	856195002108538
USSD Code	*138# <input type="button" value="Submit"/>
Receive SMS	<input type="button" value="Get"/>

You will receive a confirmation. To check the SMS response, click **Get**.

SIM Status	
WAN Connection	Cellular
SIM Card	1
IMSI	856195002108538
USSD Code	*138# <input type="button" value="Submit"/>
USSD Status	Request is sent successfully
Receive SMS	<input type="button" value="Get"/>

After a few minutes you will receive a response to your USSD code

Received SMS	
May 27 20:02	<p>PCX As of May 27th Account Balance: \$ 0.00 Amount Unbilled Voice Calls: 0 minutes Video Calls: 0 minutes SMS (Roaming): 0 SMS (Within Network): 0 MMS (Roaming):0 MMS (Within Network): 0 Data Usage: 7384KB (For reference only, please refer to bill)</p>
Aug 8 , 2013 14:51	<p>PCX iPhone & Android users need to make sure "PCX" is entered as the APN under "Settings" > "Mobile network setting" for web browsing and mobile data service. Other handset models will receive handset settings via SMS shortly (PIN: 1234) (Consumer Service Hotline: 1000 / Business Customer Hotline 10088)</p>

SMS

The SMS option allows you to read SMS (text) messages that have been sent to the SIM in your Peplink router.

SIM Status	
WAN Connection	Cellular
SIM Card	1
IMSI	2345678901234567890
Tool	SMS

SMS		Refresh
Jun 21, 2017 18:00	<p>Hi Thank you, your web password is verified - you can change this when you first login at http://www.us.ik</p>	✖
May 06, 2017 12:23	<p>Hi! Hi! Your new bill is ready to view. Go to your My3 account on your desktop or on a mobile phone click here http://www.3.com.sg/portal</p>	✖
Mar 15, 2017 10:03	<p>From 3com Hi! There is planned maintenance in the Singapore area 3G/4G services next. If your service is affected, you can get updates here http://3.com.sg</p>	✖
Mar 06, 2017 14:50	<p>Hi! Hi! Your new bill is ready to view. Go to your My3 account on your desktop or on a mobile phone click here http://www.3.com.sg/portal</p>	✖
Dec 28, 2016 09:53	<p>Hi, we have your registration to receive full price offer that we contact you, this offer applied to your first 3 bills, your monthly recharge charge will be set to full price after that 3 bills.</p>	✖
Dec 06, 2016 13:09	<p>Hi! Hi! Your new bill is ready to view. Go to your My3 account on your desktop or on a mobile phone click here http://www.3.com.sg/portal</p>	✖
Nov 08, 2016 11:29	<p>From 3com Hi! There is planned maintenance in the Singapore area 3G/4G services next. If your service is affected, you can get updates here http://3.com.sg</p>	✖
Sep 07, 2016 17:05	<p>From 3com Hi! We have your registration to receive full price offer that we contact you, this offer applied to your first 3 bills, your monthly recharge charge will be set to full price after that 3 bills.</p>	✖

14 AP Tab

14.1 AP

14.1.1 AP Controller

Clicking on the **AP** tab will default to this menu, where you can view basic AP management options:

AP Controller	
AP Management	<input checked="" type="checkbox"/>
Support Remote AP	<input type="checkbox"/>
Sync. Method	As soon as possible ▾
Permitted AP	<input type="radio"/> Any <input checked="" type="radio"/> Approved List <div style="border: 1px solid gray; height: 100px; width: 100%;"></div> <p>(One serial number per line)</p>

AP Controller	
AP Management	<p>The AP controller for managing Pepwave APs can be enabled by checking this box. When this option is enabled, the AP controller will wait for management connections originating from APs over the LAN on TCP and UDP port 11753. It will also wait for captive portal connections on TCP port 443. An extended DHCP option, CAPWAP Access Controller addresses (field 138), will be added to the DHCP server. A local DNS record, AP Controller, will be added to the local DNS proxy.</p>
Support Remote AP	<p>The AP controller supports remote management of Pepwave APs. When this option is enabled, the AP controller will wait for management connections originating from remote APs over the WAN on TCP and UDP port 11753. It will also wait for captive portal connections on TCP port 443.</p> <p>The DHCP server and/or local DNS server of the remote AP's network should be configured in the DNS Proxy Settings menu under Network>LAN. The procedure is as follows:</p> <ol style="list-style-type: none"> 1. Define an extended DHCP option, CAPWAP Access Controller addresses (field 138), in the DHCP server, where the values are the AP controller's public IP addresses; and/or 2. Create a local DNS record for the AP controller with a value corresponding to the AP controller's public IP address.

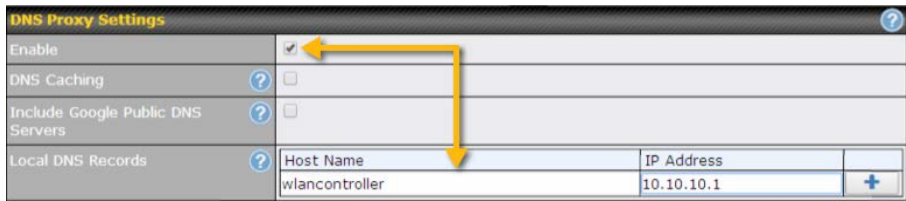
	
Sync. Method	<p>Select the required option to synchronize the managed AP's. Options are:</p> <ul style="list-style-type: none"> • As soon as possible (default) • Progressively (synchronize AP's in groups) • One at a time (synchronize one AP at a time)
Permitted AP	<p>Access points to manage can be specified here. If Any is selected, the AP controller will manage any AP that reports to it. If Approved List is selected, only APs with serial numbers listed in the provided text box will be managed.</p>

14.1.2 Wireless SSID

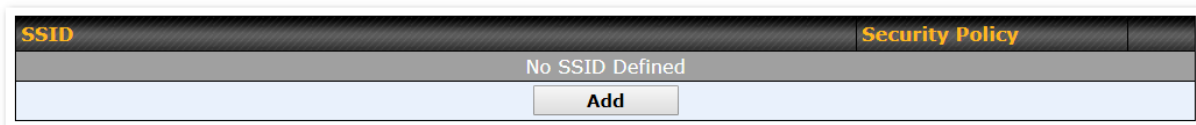

Current SSID information appears in the **SSID** section. To edit an existing SSID, click its name in the list. To add a new SSID, click **Add**. Note that the following settings vary by model. The below settings show a new SSID window with Advanced Settings enabled (these are available by selecting the question mark in the top right corner).



SSID	
SSID Settings	
SSID	PEPLINK_63E6
Enable	Always on
VLAN	0 (0: Untagged) <input type="checkbox"/> Use VLAN Pool
Broadcast SSID	<input checked="" type="checkbox"/>
Data Rate	<input checked="" type="radio"/> Auto <input type="radio"/> Fixed
Multicast Filter	<input type="checkbox"/>
Multicast Rate	MCS0/6M
IGMP Snooping	<input type="checkbox"/>
DHCP Relay	<input type="checkbox"/>
DHCP Option 82	<input type="checkbox"/>
Network Priority (QoS)	Gold
Layer 2 Isolation	<input type="checkbox"/>
Maximum number of clients	2.4 GHz: 0 5 GHz: 0 (0: Unlimited)
Band Steering	<input type="checkbox"/> Disable

SSID Settings	
SSID	This setting specifies the SSID of the virtual AP to be scanned by Wi-Fi clients.
Enable	Click the drop-down menu to apply a time schedule to this interface
VLAN	This setting specifies the VLAN ID to be tagged on all outgoing packets generated from this wireless network (i.e., packets that travel from the Wi-Fi segment through the Pepwave AP One unit to the Ethernet segment via the LAN port). The default value of this setting is 0 , which means VLAN tagging is disabled (instead of tagged with zero). Use of a VLAN pool is enabled by selecting the checkbox.
Broadcast SSID	This setting specifies whether or not Wi-Fi clients can scan the SSID of this wireless network. Broadcast SSID is enabled by default.
Data Rate ^A	Select Auto to allow the Pepwave router to set the data rate automatically, or select Fixed and choose a rate from the displayed drop-down menu.
Multicast Filter ^A	This setting enables the filtering of multicast network traffic to the wireless SSID.
Multicast Rate ^A	This setting specifies the transmit rate to be used for sending multicast network traffic. The selected Protocol and Channel Bonding settings will affect the rate options and values available here.
IGMP Snooping ^A	To allow the Pepwave router to listen to internet group management protocol (IGMP) network traffic, select this option.

DHCP Relay	Put the address of the DHCP server in this field.. DHCP requests will be relayed to this DHCP server
DHCP Option 82 ^A	If you use a distributed DHCP server/relay environment, you can enable this option to provide additional information on the manner in which clients are physically connected to the network.
Layer 2 Isolation ^A	Layer 2 refers to the second layer in the ISO Open System Interconnect model. When this option is enabled, clients on the same VLAN, SSID, or subnet are isolated to that VLAN, SSID, or subnet, which can enhance security. Traffic is passed to upper communication layer(s). By default, the setting is disabled.
Maximum Number of Clients	Indicate the maximum number of clients that should be able to connect to each frequency.
Band Steering	To reduce 2.4 GHz band overcrowding, AP with band steering steers clients capable of 5 GHz operation to 5 GHz frequency. Choose between: Force - Clients capable of 5 GHz operation are only offered with 5 GHz frequency. Prefer - Clients capable of 5 GHz operation are encouraged to associate with 5 GHz frequency. If the clients insist to attempt on 2.4 GHz frequency, 2.4 GHz frequency will be offered. Disable - Default

^A - Advanced feature. Click the button on the top right-hand corner to activate.

Security Settings	
Security Policy	WPA/WPA2 - Personal ▾
Encryption	TKIP/AES:CCMP
Shared Key	<div style="display: flex; align-items: center;"> <div style="border: 1px solid #ccc; padding: 2px;"> </div> </div> <input checked="" type="checkbox"/> Hide Characters

Security Settings

This setting configures the wireless authentication and encryption methods. Available options:

- **Open** (No Encryption)
- **Enhanced Open** (OWE)
- **WPA3 -Personal** (AES:CCMP)
- **WPA2/WPA3 -Personal** (AES:CCMP)
- **WPA2 -Personal** (AES:CCMP)
- **WPA2 – Enterprise**
- **WPA/WPA2 - Personal** (TKIP/AES: CCMP)
- **WPA/WPA2 – Enterprise**

Security Policy

When **WPA/WPA2 - Enterprise** is configured, RADIUS-based 802.1 x authentication is enabled. Under this configuration, the **Shared Key** option should be disabled. When using this method, select the appropriate version using the **V1/V2** controls. The security level of this method is known to be very high.

When **WPA/WPA2- Personal** is configured, a shared key is used for data encryption and

authentication. When using this configuration, the **Shared Key** option should be enabled. Key length must be between eight and 63 characters (inclusive). The security level of this method is known to be high.

NOTE:

When **WPA2/WPA3- Personal** is configured, if a managed AP which is NOT WPA3 PSK capable, the AP Controller will not push those WPA3 and WPA2/WPA3 SSID to that AP.

Access Control Settings	
Restricted Mode	Deny all except listed ▼
MAC Address List ?	<input type="text"/>

Access Control Settings	
Restricted Mode	The settings allow the administrator to control access using MAC address filtering. Available options are None , Deny all except listed , Accept all except listed and Radius MAC Authentication .
MAC Address List	Connections coming from the MAC addresses in this list will be either denied or accepted based on the option selected in the previous field. If more than one MAC address needs to be entered, you can use a carriage return to separate them.

RADIUS Server Settings	Primary Server	Secondary Server
Host	<input type="text"/>	<input type="text"/>
Secret	<input type="text"/> <input checked="" type="checkbox"/> Hide Characters	<input type="text"/> <input checked="" type="checkbox"/> Hide Characters
Authentication Port	1812 <input type="button" value="Default"/>	1812 <input type="button" value="Default"/>
Accounting Port	1813 <input type="button" value="Default"/>	1813 <input type="button" value="Default"/>
NAS-Identifier	Device Name ▼	

RADIUS Server Settings	
Host	Enter the IP address of the primary RADIUS server and, if applicable, the secondary RADIUS server.
Secret	Enter the RADIUS shared secret for the primary server and, if applicable, the secondary RADIUS server.
Authentication Port	In the field, enter the UDP authentication port(s) used by your RADIUS server(s) or click the Default button to enter 1812 .
Accounting	In the field, enter the UDP accounting port(s) used by your RADIUS server(s) or click the

Port	Default button to enter 1813 .
NAS-Identifier	Choose between Device Name , LAN MAC address , Device Serial Number and Custom Value

Guest Protect			
Block All Private IP	<input type="checkbox"/>		
Custom Subnet	Network	Subnet Mask	
	<input type="text"/>	255.255.255.0 (/24) ▾	<input type="button" value="+"/>
Block Exception	Network	Subnet Mask	
	<input type="text"/>	255.255.255.0 (/24) ▾	<input type="button" value="+"/>

Guest Protect	
Block All Private IP	Check this box to deny all connection attempts by private IP addresses.
Custom Subnet	To create a custom subnet for guest access, enter the IP address and choose a subnet mask from the drop-down menu.
Block Exception	To block access from a particular subnet, enter the IP address and choose a subnet mask from the drop-down menu.

Firewall Settings	
Firewall Mode	<div style="border: 1px solid black; padding: 2px;"> Disable ▾ Disable Flexible - Allow all except... Lockdown - Block all except... </div>

Firewall Settings	
Firewall Mode	The settings allow administrators to control access to the SSID based on Firewall Rules. Available options are Disable , Lockdown - Block all except... and Flexible -Allow all except...
Firewall Exceptions	Create Firewall Rules based on Port , IP Network , MAC address or Domain Name

14.1.3 Wireless Mesh

Wireless Mesh	Frequency Band
No Wireless Mesh Defined	
<input type="button" value="Add"/>	

Wireless Mesh Support is available on devices running 802.11ac (Wi-Fi 5) and above. Along with the AP Controller, mesh network extensions can be established, which can expand network coverage. Note that the Wireless Mesh settings need to match the Mesh ID and Shared Key of the other devices on the same selected frequency band.

To create a new Wireless Mesh profile, go to **AP > Wireless Mesh**, and click **Add**.

Wireless Mesh Settings
✕

Mesh ID	<input type="text"/>
Frequency	<input checked="" type="radio"/> 2.4 GHz <input type="radio"/> 5 GHz
Shared Key	<input type="text"/> <input checked="" type="checkbox"/> Hide Characters

Wireless Mesh Settings	
Mesh ID	Enter a name to represent the Mesh profile.
Frequency	Select the 2.4GHz or 5GHz frequency to be used.
Shared Key	Enter the shared key in the text field. Please note that it needs to match the shared keys of the other APs in the Wireless Mesh settings. Click Hide / Show Characters to toggle visibility.

14.1.4 AP > Profiles

AP Settings
?

AP Profile Name	<input type="text"/>
SSID	<input checked="" type="radio"/> 2.4 GHz <input type="radio"/> 5 GHz <input type="checkbox"/> PEPLINK_63E6
Operating Country	United States ▾
Preferred Frequency	<input checked="" type="radio"/> 2.4 GHz <input type="radio"/> 5 GHz

AP Settings	
AP Profile Name	Ap Profile name

SSID	You can select the wireless networks for 2.4 GHz or 5 GHz separately for each SSID.
Operating Country	<p>This drop-down menu specifies the national/regional regulations which the Wi-Fi radio should follow.</p> <ul style="list-style-type: none"> If a North American region is selected, RF channels 1 to 11 will be available and the maximum transmission power will be 26 dBm (400 mW). If European region is selected, RF channels 1 to 13 will be available. The maximum transmission power will be 20 dBm (100 mW). <p>NOTE: Users are required to choose an option suitable to local laws and regulations.</p>
Preferred Frequency	Indicate the preferred frequency to use for clients to connect.

Important Note

Per FCC regulation, the country selection is not available on all models marketed in the US. All US models are fixed to US channels only.

	2.4 GHz	5 GHz
Protocol	802.11ng	802.11n/ac
Channel Width	Auto	Auto
Channel	Auto <input type="button" value="Edit"/> Channels: 1 2 3 4 5 6 7 8 9 10 11	Auto <input type="button" value="Edit"/> Channels: 36 40 44 48 149 153 157 161 165
Auto Channel Update	Daily at 03:00 <input checked="" type="checkbox"/> Wait until no active client associated	Daily at 03:00 <input checked="" type="checkbox"/> Wait until no active client associated
Output Power	Fixed: Max <input type="checkbox"/> Boost	Fixed: Max <input type="checkbox"/> Boost
Client Signal Strength Threshold	0 -95 dBm (0: Unlimited)	0 -95 dBm (0: Unlimited)
Maximum number of clients	0 (0: Unlimited)	0 (0: Unlimited)

AP Settings (part 2)

Protocol	This option allows you to specify whether 802.11b and/or 802.11g client association requests will be accepted. Available options are 802.11ng and 802.11na . By default, 802.11ng is selected.
Channel Width	Available options are 20 MHz , 40 MHz , and Auto (20/40 MHz) . Default is Auto (20/40 MHz) , which allows both widths to be used simultaneously.
Channel	This option allows you to select which 802.11 RF channel will be utilized. Channel 1 (2.412 GHz) is selected by default.
Auto Channel Update	Indicate the time of day at which update automatic channel selection.
Output Power	This option is for specifying the transmission output power for the Wi-Fi AP. There are 4 relative power levels available – Max , High , Mid , and Low . The actual output power will be bound by the regulatory limits of the selected country.
Client Signal Strength Threshold	Clients with signal strength lower than this value will not be allowed to connect.

Maximum number of clients This setting determines the maximum number of clients that can connect to this Wi-Fi frequency.

Advanced Wi-Fi AP settings can be displayed by clicking the  on the top right-hand corner of the **Wi-Fi AP Settings** section, which can be found at **AP>Settings**. Other models will display a separate section called **Wi-Fi AP Advanced Settings**, which can be found at **Advanced>Wi-Fi Settings**.

Management VLAN ID	 0 (0: Untagged)
Operating Schedule	Always on ▾
Beacon Rate	 1 Mbps ▾
Beacon Interval	 100 ms ▾
DTIM	 1 Default
RTS Threshold	0 Default
Fragmentation Threshold	0 (0: Disable) Default
Distance / Time Converter	<input type="text" value="4050"/> m <small>Note: Input distance for recommended values</small>
Slot Time	 <input type="radio"/> Auto <input checked="" type="radio"/> Custom <input type="text" value="9"/> μ s Default
ACK Timeout	 48 μ s Default
Frame Aggregation	<input checked="" type="checkbox"/>
Aggregation Length	<input type="text" value="50000"/> Default

Advanced AP Settings	
Management VLAN ID	<p>This field specifies the VLAN ID to tag to management traffic, such as communication traffic between the AP and the AP Controller. The value is zero by default, which means that no VLAN tagging will be applied.</p> <p>NOTE: Change this value with caution as alterations may result in loss of connection to the AP Controller.</p>
Operating Schedule	Choose from the schedules that you have defined in System>Schedule. Select the schedule for the integrated AP to follow from the drop-down menu.
Beacon Rate ^A	This option is for setting the transmit bit rate for sending a beacon. By default, 1Mbps is selected.
Beacon Interval ^A	This option is for setting the time interval between each beacon. By default, 100ms is selected.
DTIM ^A	This field allows you to set the frequency for the beacon to include delivery traffic indication messages. The interval is measured in milliseconds. The default value is set to 1 ms .
RTS Threshold ^A	The RTS (Request to Clear) threshold determines the level of connection required before the AP starts sending data. The recommended standard of the RTS threshold is around 500.

Fragmentation Threshold ^A	This setting determines the maximum size of a packet before it gets fragmented into multiple pieces.
Distance / Time Convertor	Select the range you wish to cover with your Wi-Fi, and the router will make recommendations for the Slot Time and ACK Timeout.
Slot Time ^A	This field is for specifying the unit wait time before transmitting a packet. By default, this field is set to 9 μs .
ACK Timeout ^A	This field is for setting the wait time to receive an acknowledgement packet before performing a retransmission. By default, this field is set to 48 μs .
Frame Aggregation ^A	This option allows you to enable frame aggregation to increase transmission throughput.

^A - Advanced feature, please click the  button on the top right-hand corner to activate.

Web Administration Settings	
Enable	<input checked="" type="checkbox"/>
Web Access Protocol	<input type="radio"/> HTTP <input checked="" type="radio"/> HTTPS
Management Port	<input type="text" value="443"/>
HTTP to HTTPS Redirection	<input checked="" type="checkbox"/>
Admin Username	<input type="text" value="admin"/>
Admin Password	<input type="password" value="....."/> <input type="button" value="Generate"/>
	<input checked="" type="checkbox"/> Hide Characters

Web Administration Settings	
Enable	Ticking this box enables web admin access for APs located on the WAN.
Web Access Protocol	Determines whether the web admin portal can be accessed through HTTP or HTTPS
Management Port	Determines the port at which the management UI can be accessed.
HTTP to HTTPS redirection	Redirects HTTP request to HTTPS
Admin Username	Determines the username to be used for logging into the web admin portal
Admin Password	Determines the password for the web admin portal on external AP.

14.2 AP Controller Status

14.2.1 Info

A comprehensive overview of your AP can be accessed by navigating to **AP > Info**.



AP Controller	
License Limit	This field displays the maximum number of AP your Balance router can control. You can purchase licenses to increase the number of AP you can manage.
Frequency	Underneath, there are two check boxes labeled 2.4 Ghz and 5 Ghz . Clicking either box will toggle the display of information for that frequency. By default, the graphs display the number of clients and data usage for both 2.4GHz and 5 GHz frequencies.
SSID	The colored boxes indicate the SSID to display information for. Clicking any colored box will toggle the display of information for that SSID. By default, all the graphs show information for all SSIDs.
No. of APs	This pie chart and table indicates how many APs are online and how many are offline.
No. of Clients	This graph displays the number of clients connected to each network at any given time. Mouse over any line on the graph to see how many clients connected to a specific SSID for that point in time.

Data Usage

This graph enables you to see the data usage of any SSID for any given time period. Mouse over any line on the graph to see the data usage by each SSID for that point in time. Use the buttons next to **Zoom** to select the time scale you wish to view. In addition, you could use the sliders at the bottom to further refine your timescale.

14.2.2 Access Points (Usage)

A detailed breakdown of data usage for each AP is available at **AP> Access Point**.

Search Filter

AP Name / Serial Number / SSID	All <input type="text"/>
	<input type="checkbox"/> Include Offline APs
Search Result	

Managed APs Expand Collapse

Name	IP Address	MAC	Location	Firmware Pack ID	Configuration
▼ Default (8/9 online)					☰ ☰
☐ 1111-1111-1111	10.8.82.11	00:1A:DD:BD:73:E0	-	3.5.2 None ✓	☰ ☰ ☰ ☰

Usage

AP Name/Serial Number	This field enables you to quickly find your device if you know its name or serial number. Fill in the field to begin searching. Partial names and serial numbers are supported.
Online Status	This button toggles whether your search will include offline devices.

This table shows the detailed information on each AP, including channel, number of clients, upload traffic, and download traffic. Click the blue arrows at the left of the table to expand and collapse information on each device group. You could also expand and collapse all groups by using the Expand Collapse buttons.

On the right of the table, you will see the following icons: .

Click the icon to see a usage table for each client:

Client List ✕

MAC Address	IP Address	Type	Signal	SSID	Upload	Download
80:56:f2:98:75:ff	10.9.2.7	802.11ng	Excellent (37)	Balance	66.26 MB	36.26 MB
c4:6a:b7:bf:d7:15	10.9.2.123	802.11ng	Excellent (42)	Balance	6.65 MB	2.26 MB
70:56:81:1d:87:f3	10.9.2.102	802.11ng	Good (23)	Balance	1.86 MB	606.63 KB
e0:63:e5:83:45:c8	10.9.2.101	802.11ng	Excellent (39)	Balance	3.42 MB	474.52 KB
18:00:2d:3d:4e:7f	10.9.2.66	802.11ng	Excellent (25)	Balance	640.29 KB	443.57 KB
14:5a:05:80:4f:40	10.9.2.76	802.11ng	Excellent (29)	Balance	2.24 KB	3.67 KB
00:1a:dd:c5:4e:24	10.8.9.84	802.11ng	Excellent (29)	Wireless	9.86 MB	9.76 MB
00:1a:dd:bb:29:ec	10.8.9.73	802.11ng	Excellent (25)	Wireless	9.36 MB	11.14 MB
40:b0:fa:c3:26:2c	10.8.9.18	802.11ng	Good (23)	Wireless	118.05 MB	7.92 MB
e4:25:e7:8a:d3:12	10.10.11.23	802.11ng	Excellent (35)	Marketing	74.78 MB	4.58 MB
04:f7:e4:ef:68:05	10.10.11.71	802.11ng	Poor (12)	Marketing	84.84 KB	119.32 KB

Close

Click the icon to configure each client

AP Details	
Serial Number	1111-2222-3333
MAC Address	00:1A:DD:BD:73:E0
Product Name	Pepwave AP Pro Duo
Name	<input type="text"/>
Location	<input type="text"/>
Firmware Version	3.5.2
Firmware Pack	Default (None) ▼
AP Client Limit	<input checked="" type="radio"/> Follow AP Profile <input type="radio"/> Custom
2.4 GHz SSID List	T4Open
5 GHz SSID List	T4Open
Last config applied by controller	Mon Nov 23 11:25:03 HKT 2015
Uptime	Wed Nov 11 15:00:27 HKT 2015
Current Channel	1 (2.4 GHz) 153 (5 GHz)
Channel	2.4 GHz: Follow AP Profile ▼ 5 GHz: Follow AP Profile ▼
Output Power	2.4 GHz: Follow AP Profile ▼ 5 GHz: Follow AP Profile ▼

For easier network management, you can give each client a name and designate its location. You can also designate which firmware pack (if any) this client will follow, as well as the channels on which the client will broadcast.

Click the  icon to see a graph displaying usage:

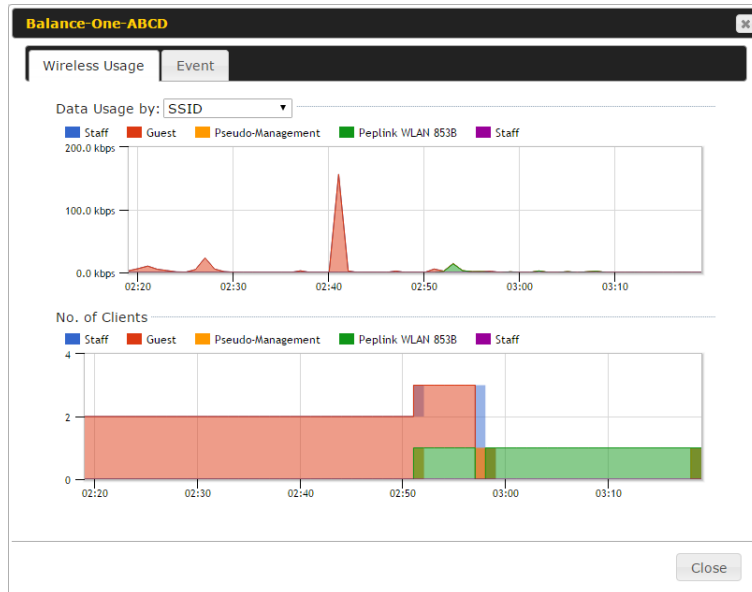

Click any point in the graphs to display detailed usage and client information for that device, using that SSID, at that point in time. On the **Data Usage by** menu, you can display the information by SSID or by AP send/receive rate.

Click the **Event** tab next to **Wireless Usage** to view a detailed event log for that particular device:

Event Information
✕

Events

Jan 2 11:53:39	Client 00:26:BB:08:AC:FD associated with Wireless_11a
Jan 2 11:39:31	Client 60:67:20:24:B6:4C disassociated from Marketing_11a
Jan 2 11:16:55	Client A8:BB:CF:E1:0F:1E disassociated from Balance_11a
Jan 2 11:11:54	Client A8:BB:CF:E1:0F:1E associated with Balance_11a
Jan 2 11:10:45	Client 60:67:20:24:B6:4C associated with Marketing_11a
Jan 2 11:00:36	Client 00:21:6A:35:59:A4 associated with Balance_11a
Jan 2 11:00:20	Client 60:67:20:24:B6:4C disassociated from Marketing_11a
Jan 2 10:59:09	Client 00:21:6A:35:59:A4 disassociated from Balance_11a
Jan 2 10:42:28	Client F4:B7:E2:16:35:E9 associated with Balance_11a
Jan 2 10:29:12	Client 84:7A:88:78:1E:4B associated with Balance_11a
Jan 2 10:24:27	Client 90:B9:31:0D:11:EC disassociated from Marketing_11a
Jan 2 10:24:27	Client 90:B9:31:0D:11:EC roamed to Marketing_11a at 2830-BFC8-D230
Jan 2 10:13:22	Client E8:8D:28:A8:43:93 associated with Balance_11a
Jan 2 10:13:22	Client E8:8D:28:A8:43:93 roamed to Balance_11a from 2830-BF7F-694C
Jan 2 10:07:52	Client CC:3A:61:89:07:F3 associated with Wireless_11a
Jan 2 10:04:35	Client 60:67:20:24:B6:4C associated with Marketing_11a
Jan 2 10:03:38	Client 60:67:20:24:B6:4C disassociated from Marketing_11a
Jan 2 09:58:27	Client 00:26:BB:08:AC:FD disassociated from Wireless_11a
Jan 2 09:52:46	Client 00:26:BB:08:AC:FD associated with Wireless_11a
Jan 2 09:20:26	Client 8C:3A:E3:3F:17:62 associated with Balance_11a

[More...](#)

14.2.3 Wireless SSID

In-depth wireless SSID reports are available under **AP > Wireless SSID**.

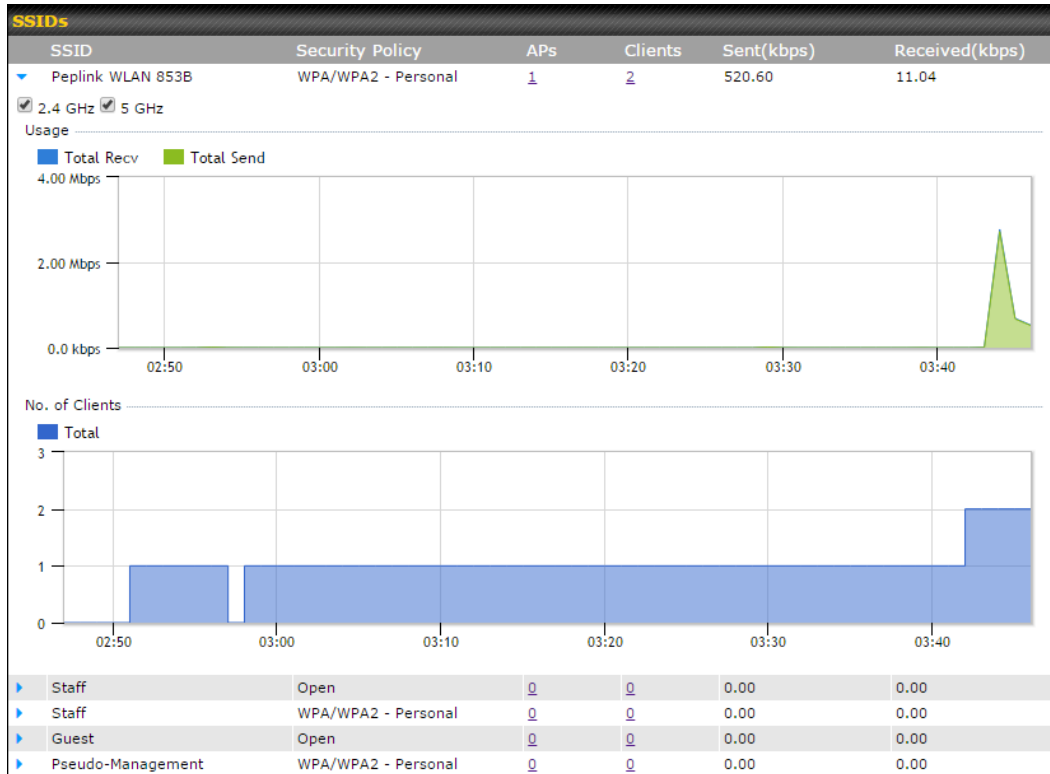

Click the blue arrow on any SSID to obtain more detailed usage information on each SSID.

14.2.4 Wireless Client

You can search for specific Wi-Fi users by navigating to **AP > Wireless Client**.

Search Filter

Client MAC / SSID / AP Serial Number	<input type="text"/>
Maximum Result (1-256)	<input type="text" value="50"/>
Search Result	

Top 10 Clients of last hour (Updated at 03:00)

Client MAC Address	Upload	Download	
C0:EE:FB:20:13:36	53.5 KB	101.4 KB	☆ 📄

Here, you will be able to see your network's heaviest users as well as search for specific users. Click the ☆ icon to bookmark specific users, and click the 📄 icon for additional details about each user:

Client C0:EE:FB:20:13:36
✕

Information

Status	Associated
Access Point	1111-2222-3333
SSID	Peplink WLAN 853B
IP Address	192.168.1.34
Duration	00:27:31
Usage (Upload / Download)	141.28 MB / 4.35 MB
RSSI	-48
Rate (Upload / Download)	150M / 48M
Type	802.11na

Download
 Upload

SSID	AP	From	To	Upload	Download
Peplink WLAN 853B	192C-1835-642F	Nov 23 03:43:04	-	141.28 MB	4.35 MB
Peplink WLAN 853B	192C-1835-642F	Nov 23 02:58:36	Nov 23 03:47:52	173.7 KB	94.2 KB
Peplink WLAN 853B	192C-1835-642F	Nov 23 02:52:15	Nov 23 02:58:15	105.9 KB	62.5 KB

14.2.5 Mesh / WDS

Mesh / WDS allows you to monitor the status of your wireless distribution system (WDS) or Mesh, and track activity by MAC address by navigating to **AP > Controller Status > Mesh / WDS**. This table shows the detailed information of each AP, including protocol, transmit rate (sent / received), signal strength, and duration.

Mesh / WDS						
Type	Peer MAC	Protocol	Rate (Send)	Rate (Receive)	Signal (dBm)	Duration
▼ APOACM-HW1/ [redacted]						
Mesh [redacted]	[redacted]	802.11ac	325M	650M	-56	19:13:35
▼ APOACM-HW2/ [redacted]						
Mesh [redacted]	[redacted]	802.11ac	650M	351M	-63	00:49:20
Mesh [redacted]	[redacted]	802.11ac	390M	325M	-67	01:35:09
▼ APOE-HW1/ [redacted]						
Mesh [redacted]	[redacted]	802.11ac	58.5M	130M	-69	00:45:22
▼ APOR-HW1/ [redacted]						
Mesh [redacted]	[redacted]	802.11ac	325M	866.7M	-53	19:14:44
▼ B20X-MESH-GW/ [redacted]						
Mesh [redacted]	[redacted]	802.11ac	433M	650M	-69	19:14:44
Mesh [redacted]	[redacted]	802.11ac	325M	390M	-66	01:35:42
Mesh [redacted]	[redacted]	802.11ac	351M	650M	-70	19:13:45
Mesh [redacted]	[redacted]	802.11ac	130M	117M	-88	00:45:52

Network Graph

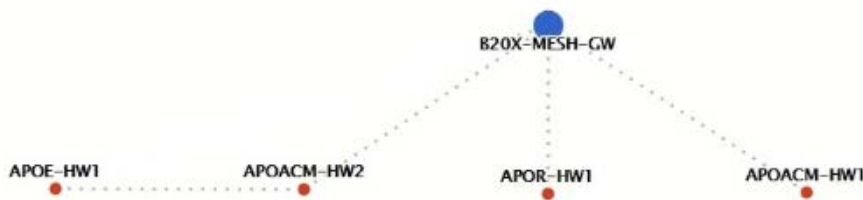

14.2.6 Nearby Device

A listing of near devices can be accessed by navigating to **AP > Controller Status > Nearby Device**.

Suspected Rogue APs					
BSSID	SSID	Channel	Encryption	Last Seen	Mark as
00:1A:DD:EC:25:22	Wireless	11	WPA2	10 hours ago	
00:1A:DD:EC:25:23	Accounting	11	WPA2	10 hours ago	
00:1A:DD:EC:25:24	Marketing	11	WPA2	11 hours ago	
00:03:7F:00:00:00	MYB1PUSH	1	WPA & WPA2	11 minutes ago	
00:03:7F:00:00:01	MYB1	1	WPA2	15 minutes ago	
00:1A:DD:B9:60:88	PEPWAVE_CB7E	1	WPA & WPA2	5 minutes ago	
00:1A:DD:BB:09:C1	Micro_S1_1	6	WPA & WPA2	1 hour ago	
00:1A:DD:BB:52:A8	MAX HD2 Gobi	11	WPA & WPA2	2 minutes ago	
00:1A:DD:BF:75:81	PEPLINK_05B5	4	WPA & WPA2	1 minute ago	
00:1A:DD:BF:75:82	LK_05B5	4	WPA2	1 minute ago	
00:1A:DD:BF:75:83	LK_05B5_VLAN22	4	WPA2	1 minute ago	
00:1A:DD:C1:ED:E4	dev_captive_portal_test	1	WPA & WPA2	3 minutes ago	
00:1A:DD:C2:E4:C5	PEPWAVE_7052	11	WPA & WPA2	2 hours ago	
00:1A:DD:C3:F1:64	dev_captive_portal_test	6	WPA & WPA2	6 minutes ago	
00:1A:DD:C4:DC:24	ssid_test	8	WPA & WPA2	2 minutes ago	
00:1A:DD:C4:DC:25	SSID New	8	WPA & WPA2	2 minutes ago	
00:1A:DD:C5:46:04	Guest SSID	9	WPA2	2 minutes ago	
00:1A:DD:C5:47:04	PEPWAVE_67B8	1	WPA & WPA2	5 minutes ago	
00:1A:DD:C5:4E:24	G BR1 Portal	2	WPA2	2 minutes ago	
00:1A:DD:C6:9A:48	ssid_test	8	WPA & WPA2	2 hours ago	

Nearby Devices

Hovering over the device MAC address will result in a popup with information on how this device was detected. Click the icons and the device will be moved to the bottom table of identified devices.

14.2.7 Event Log

You can access the AP Controller Event log by navigating to **AP > Controller Status > Event Log**.

Filter	
Search key	<input type="text" value="Client MAC Address / Wireless SSID / AP Serial Number / AP Profile Name"/>
Time	From <input type="text"/> hh:mm to <input type="text"/> hh:mm
Alerts only	<input type="checkbox"/>
<input type="button" value="Search"/>	

Events		View Alerts
Jan 2 11:01:11	AP One 300M: Client 54:EA:40:3D:A0:D9 disassociated from Marketing_11a	
Jan 2 11:00:42	AP One 300M: Client 54:EA:40:3D:A0:D9 associated with Marketing_11a	
Jan 2 11:00:38	AP One 300M: Client 54:EA:40:3D:A0:D9 disassociated from Marketing_11a	
Jan 2 11:00:36	AP One 300M: Client 00:11:6A:3E:99:A8 associated with Balance_11a	
Jan 2 11:00:20	AP One 300M: Client 60:67:20:24:06:4C disassociated from Marketing_11a	
Jan 2 11:00:09	AP One 300M: Client 54:EA:40:3D:A0:D9 associated with Marketing_11a	
Jan 2 10:59:09	AP One 300M: Client 00:11:6A:3E:99:A8 disassociated from Balance_11a	
Jan 2 10:59:08	Office Fiber AP: Client 18:00:3D:3D:46:7F associated with Balance	
Jan 2 10:58:53	Michael's Desk: Client 18:00:3D:3D:46:7F disassociated from Wireless	
Jan 2 10:58:18	AP One 300M: Client 54:EA:40:3D:A0:D9 disassociated from Marketing_11a	
Jan 2 10:58:03	Office InWall: Client 50:8F:40:89:78:C7 associated with Wireless	
Jan 2 10:57:47	AP One 300M: Client 54:EA:40:3D:A0:D9 associated with Marketing_11a	
Jan 2 10:57:19	AP One 300M: Client 54:EA:40:3D:A0:D9 disassociated from Marketing_11a	
Jan 2 10:57:09	AP One 300M: Client 54:EA:40:3D:A0:D9 associated with Marketing_11a	
Jan 2 10:56:48	AP One 300M: Client 54:EA:40:3D:A0:D9 disassociated from Marketing_11a	
Jan 2 10:56:39	AP One 300M: Client 54:EA:40:3D:A0:D9 associated with Marketing_11a	
Jan 2 10:56:19	AP One 300M: Client 00:11:6A:3E:99:A8 associated with Marketing_11a	
Jan 2 10:56:09	AP One 300M: Client 9C:94:5B:10:79:4C associated with Marketing_11a	
Jan 2 10:55:42	AP One 300M: Client 54:EA:40:3D:A0:D9 disassociated from Marketing_11a	
Jan 2 10:55:29	AP One 300M: Client 54:EA:40:3D:A0:D9 associated with Marketing_11a	

[More...](#)

Events

This event log displays all activity on your AP network, down to the client level. Use to filter box to search by MAC address, SSID, AP Serial Number, or AP Profile name. Click **View Alerts** to see only alerts, and click the **More...** link for additional records.

14.3 Toolbox

Additional tools for managing firmware packs, power adjustment, and channel assignment can be found at **AP>Toolbox**.

Firmware Packs

Auto Power Adj.

Dynamic Channel Assignment

Pack ID	Release Date	Details	Action
1126	2013-08-26		

Check for Updates

Manual Upload

Default...

No default defined.

Firmware Packs

This is the first menu that will appear. Here, you can manage the firmware of your AP. Clicking on will display information regarding each firmware pack. To receive new firmware packs, you can either press Check for Updates to download new packs or you can press Manual Upload to manually upload a firmware pack. Press Default... to define which firmware pack is default.

15 System Tab

15.1 System

15.1.1 Admin Security

There are two types of user accounts available for accessing the web admin: *admin* and *user*. They represent two user levels: the admin level has full administrative access, while the user level is read-only. The user level can access only the device's status information; users cannot make any changes on the device.

A web login session will be logged out automatically when it has been idle longer than the **Web Session Timeout**. Before the session expires, you may click the **Logout** button in the web admin to exit the session.

0 hours 0 minutes signifies an unlimited session time. This setting should be used only in special situations, as it will lower the system security level if users do not log out before closing the browser. The **default** is 4 hours, 0 minutes.

For security reasons, after logging in to the web admin Interface for the first time, it is recommended to change the administrator password. Configuring the administration interface to be accessible only from the LAN can further improve system security. Administrative settings configuration is located at **System>Admin Security**.

Admin Settings ?	
Router Name	<input type="text"/> hostname: <input type="text"/> ⚙️ This configuration is being managed by InControl.
Admin User Name	<input type="text" value="admin"/>
Admin Password	<input type="password" value="....."/>
Confirm Admin Password	<input type="password" value="....."/>
Read-only User Name	<input type="text" value="user"/>
User Password	<input type="password"/>
Confirm User Password	<input type="password"/>
Front Panel Passcode	<input type="checkbox"/>
Web Session Timeout	? <input type="text" value="4"/> Hours <input type="text" value="0"/> Minutes
Authentication by RADIUS	? <input type="checkbox"/> Enable
CLI SSH & Console	? <input type="checkbox"/> Enable
Security	HTTP / HTTPS ▾ <input checked="" type="checkbox"/> Redirect HTTP to HTTPS
Web Admin Access	HTTP: <input type="text" value="LAN Only"/> HTTPS: <input type="text" value="LAN Only"/> ▾
Web Admin Port	HTTP: <input type="text" value="80"/> HTTPS: <input type="text" value="443"/>
LAN Connection Access Settings	
Allowed LAN Networks	<input checked="" type="radio"/> Any <input type="radio"/> Allow this network only
<input type="button" value="Save"/>	

Admin Settings	
Router Name	This field allows you to define a name for this Pepwave router. By default, Router Name is set as MAX_XXXX , where XXXX refers to the last 4 digits of the unit's serial number.
Admin User Name	Admin User Name is set as <i>admin</i> by default, but can be changed, if desired.
Admin Password	This field allows you to specify a new administrator password.
Confirm Admin Password	This field allows you to verify and confirm the new administrator password.
Read-only User Name	Read-only User Name is set as <i>user</i> by default, but can be changed, if desired.
User Password	This field allows you to specify a new user password. Once the user password is set, the read-only user feature will be enabled.

Confirm User Password	This field allows you to verify and confirm the new user password.
Web Session Timeout	This field specifies the number of hours and minutes that a web session can remain idle before the Pepwave router terminates its access to the web admin interface. By default, it is set to 4 hours .
Authentication by RADIUS	With this box is checked, the web admin will authenticate using an external RADIUS server. Authenticated users are treated as either "admin" with full read-write permission or "user" with read-only access. Local admin and user accounts will be disabled. When the device is not able to communicate with the external RADIUS server, local accounts will be enabled again for emergency access. Additional authentication options will be available once this box is checked.
Auth Protocol	This specifies the authentication protocol used. Available options are MS-CHAP v2 and PAP .
Auth Server	This specifies the access address and port of the external RADIUS server.
Auth Server Secret	This field is for entering the secret key for accessing the RADIUS server.
Auth Timeout	This option specifies the time value for authentication timeout.
Accounting Server	This specifies the access address and port of the external accounting server.
Accounting Server Secret	This field is for entering the secret key for accessing the accounting server.
Network Connection	This option is for specifying the network connection to be used for authentication. Users can choose from LAN, WAN, and VPN connections.
CLI SSH	The CLI (command line interface) can be accessed via SSH. This field enables CLI support. For additional information regarding CLI, please refer to Section 15.3 .
CLI SSH Access	This menu allows you to choose between granting access to LAN and WAN clients, or to LAN clients only.
CLI SSH Port	This field determines the port on which clients can access CLI SSH.
CLI SSH Login Grace Time	This option specifies the time for CLI SSH login. The default value is 120.
CLI SSH Access Public Key	This field is for entering the Public Key for Admin Users and Read-only Users to access CLI SSH.
Security	This option is for specifying the protocol(s) through which the web admin interface can be accessed: <ul style="list-style-type: none"> • HTTP

	<ul style="list-style-type: none"> • HTTPS • HTTP/HTTPS <p>HTTP to HTTPS redirection is enabled by default to force HTTPS access to the web admin interface.</p>
Web Admin Port	This field is for specifying the port number on which the web admin interface can be accessed.
Web Admin Access	<p>This option is for specifying the network interfaces through which the web admin interface can be accessed:</p> <ul style="list-style-type: none"> • LAN only • LAN/WAN <p>If LAN/WAN is chosen, the WAN Connection Access Settings form will be displayed.</p>

LAN Connection Access Settings

Allowed LAN Networks Any Allow this network only Public (10) ▼

LAN Connection Access Settings	
Allowed LAN Networks	This field allows you to permit only specific networks or VLANs to access the Web UI.

WAN Connection Access Settings

Allowed Source IP Subnets Any Allow access from the following IP subnets only

Allowed WAN IP Address(es)

Connection / IP Address(es)	All	Clear
<input checked="" type="checkbox"/> WAN 1	<input checked="" type="checkbox"/> 10.88.3.158 (Interface IP)	
<input type="checkbox"/> WAN 2		
<input type="checkbox"/> Wi-Fi WAN		
<input type="checkbox"/> Cellular 1		
<input type="checkbox"/> Cellular 2		
<input type="checkbox"/> USB		

WAN Connection Access Settings	
Allowed Source IP Subnets	<p>This field allows you to restrict web admin access only from defined IP subnets.</p> <ul style="list-style-type: none"> • Any - Allow web admin accesses to be from anywhere, without IP address restriction. • Allow access from the following IP subnets only - Restrict web admin access only from the defined IP subnets. When this is chosen, a text input area will be displayed beneath: <p>The allowed IP subnet addresses should be entered into this text area. Each IP subnet must be in form of <i>w.x.y.z/m</i>, where <i>w.x.y.z</i> is an IP address (e.g., <i>192.168.0.0</i>), and <i>m</i> is</p>

	<p>the subnet mask in CIDR format, which is between 0 and 32 inclusively (For example, 192.168.0.0/24).</p> <p>To define multiple subnets, separate each IP subnet one in a line. For example:</p> <ul style="list-style-type: none"> • 192.168.0.0/24 • 10.8.0.0/16
Allowed WAN IP Address(es)	This is to choose which WAN IP address(es) the web server should listen on.

15.1.2 Firmware

Upgrading firmware can be done in one of three ways.

Using the router’s interface to automatically check for an update, using the router’s interface to manually upgrade the firmware, or using InControl2 to push an upgrade to a router.

The automatic upgrade can be done from **System > Firmware**.

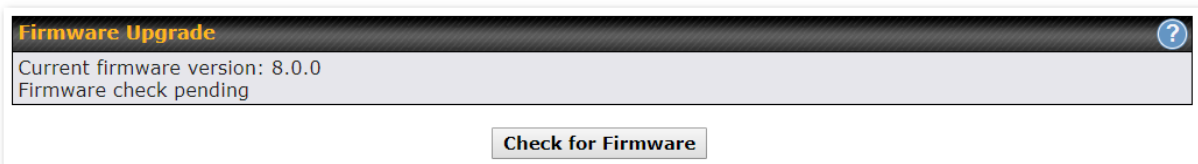

If an update is found the buttons will change to allow you to **Download and Update** the firmware.

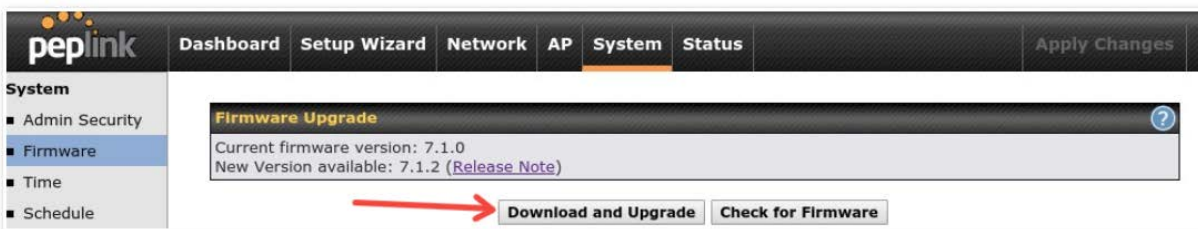

Click on the **Download and Upgrade** button. A prompt will be displayed advising to download the Current Active Configuration. Please click on the underlined download text. After downloading the current config click the **Ok** button to start the upgrade process.

The router will download and then apply the firmware. The time that this process takes will depend on your internet connection’s speed.



The firmware will now be applied to the router*. The amount of time it takes for the firmware to upgrade will also depend on the router that’s being upgraded.

Firmware Upgrade

It may take up to 8 minutes.

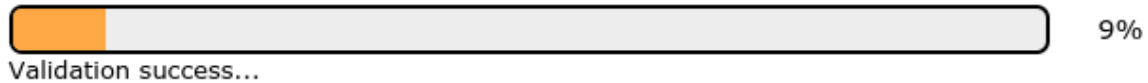

***Upgrading the firmware will cause the router to reboot.**

Web admin interface: install updates manually

In some cases, a special build may be provided via a ticket or it may be found in the forum. Upgrading to the special build can be done using this method, or using IC2 if you are using that to manage your firmware upgrades. A manual upgrade using the GA firmware posted on the site may also be recommended or required for a couple of reasons.

All of the Peplink/Pepwave GA firmware can be found [here](#). Navigate to the relevant product line (ie. Balance, Max, FusionHub, SOHO, etc). Some product lines may have a dropdown that lists all of the products in that product line. Here is a screenshot from the Balance line.

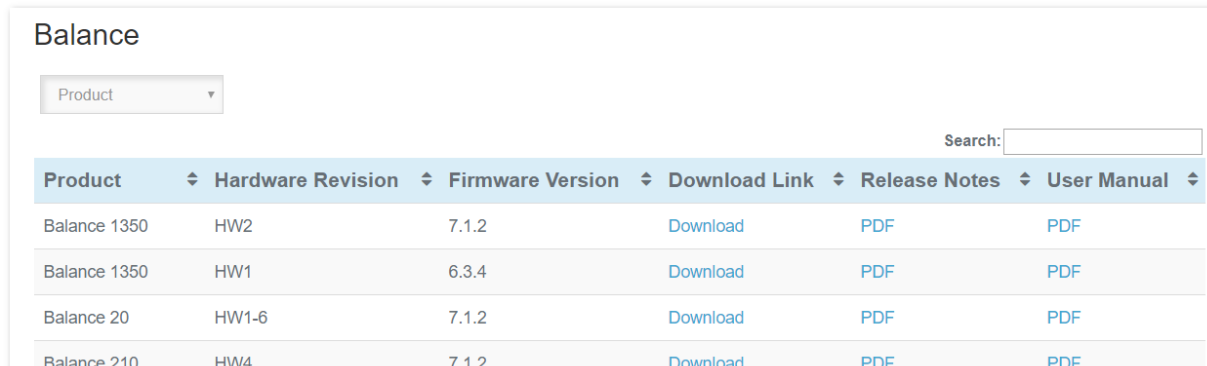

Product	Hardware Revision	Firmware Version	Download Link	Release Notes	User Manual
Balance 1350	HW2	7.1.2	Download	PDF	PDF
Balance 1350	HW1	6.3.4	Download	PDF	PDF
Balance 20	HW1-6	7.1.2	Download	PDF	PDF
Balance 210	HW4	7.1.2	Download	PDF	PDF

If the device has more than one firmware version the current hardware revision will be required to know what firmware to download.

Navigate to System > Firmware and click the Choose File button under the Manual Firmware Upgrade section. Navigate to the location that the firmware was downloaded to select the “.img” file and click the Open button.

Click on the Manual Upgrade button to start the upgrade process.

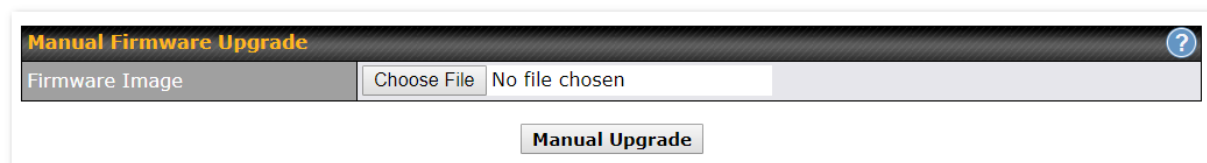

Manual Firmware Upgrade ?

Firmware Image No file chosen

A prompt will be displayed advising to download the Current Active Configuration. Please click on the underlined download text. After downloading the current config click the Ok button to

start the upgrade process. The firmware will now be applied to the router*. The amount of time it takes for the firmware to upgrade will depend on the router that's being upgraded.

Firmware Upgrade

It may take up to 8 minutes.



***Upgrading the firmware will cause the router to reboot.**

The InControl method

[Described in this knowledgebase article on our forum.](#)

15.1.3 Time

The time server functionality enables the system clock of the Peplink Balance to be synchronized with a specified time server. The settings for time server configuration are located at **System>Time**.

Time Settings	
Time Zone	(GMT) Greenwich Mean Time : Dublin, Edinburgh, Lisbon, Lon ▼ <input type="checkbox"/> Show all
Time Server	0.pepwave.pool.ntp.org <input type="button" value="Default"/>
<input type="button" value="Save"/>	

Time Settings	
Time Zone	This specifies the time zone (along with the corresponding Daylight Savings Time scheme) in which Peplink Balance operates. The Time Zone value affects the time stamps in the event log of the Peplink Balance and e-mail notifications. Check Show all to show all time zone options.
Time Server	This setting specifies the NTP network time server to be utilized by the Peplink Balance.

15.1.4 Schedule

Enable and disable different functions (such as WAN connections, outbound policy, and firewalls) at different times, based on a user-scheduled configuration profile. The settings for this are

located at **System > Schedule**

Schedule			
Enabled			
Name	Time	Used by	
Weekdays Only	Weekdays only	-	
New Schedule			

Enable scheduling, and then click on your schedule name or on the **New Schedule** button to begin.

Edit schedule profile

Schedule Settings

Enable	<input checked="" type="checkbox"/> <small>The schedule function of those associated features will be lost if profile is disabled.</small>
Name	<input type="text" value="Weekdays Only"/>
Schedule	<input type="text" value="Weekdays only"/>
Used by	<small>You may go to supported feature settings page and set this profile as scheduler.</small>

Schedule Map

	Midnight	4am	8am	Noon	4pm	8pm
Sunday	x	x	x	x	x	x
Monday	✓	✓	✓	✓	✓	✓
Tuesday	✓	✓	✓	✓	✓	✓
Wednesday	✓	✓	✓	✓	✓	✓
Thursday	✓	✓	✓	✓	✓	✓
Friday	✓	✓	✓	✓	✓	✓
Saturday	x	x	x	x	x	x

Edit Schedule Profile	
Enabling	Click this checkbox to enable this schedule profile. Note that if this is disabled, then any associated features will also have their scheduling disabled.
Name	Enter your desired name for this particular schedule profile.
Schedule	Click the drop-down menu to choose pre-defined schedules as your starting point. Please note that upon selection, previous changes on the schedule map will be deleted.
Schedule Map	Click on the desired times to enable features at that time period. You can hold your mouse for faster entry.

15.1.5 Email Notification

The email notification functionality of the Peplink Balance provides a system administrator with up-to-date information on network status. The settings for configuring email notification are found at **System>Email Notification**.

Email Notification Setup ?	
Email Notification	<input checked="" type="checkbox"/> Enable
SMTP Server	smtp.mycompany.com <input checked="" type="checkbox"/> Require authentication
Connection Security	SSL/TLS (Note: any server certificate will be accepted)
SMTP Port	465
SMTP User Name	smtpuser
SMTP Password	*****
Confirm SMTP Password	*****
Sender's Email Address	admin@mycompany.com
Recipient's Email Address	system@mycompany.com staff@mycompany.com

Email Notification Settings	
Email Notification	This setting specifies whether or not to enable email notification. If Enable is checked, the Peplink Balance will send email messages to system administrators when the WAN status changes or when new firmware is available. If Enable is not checked, email notification is disabled and the Peplink Balance will not send email messages.
SMTP Server	This setting specifies the SMTP server to be used for sending email. If the server requires authentication, check Require authentication .
Connection Security	This setting specifies via a drop-down menu one of the following valid Connection Security: <ul style="list-style-type: none"> ● None ● STARTTLS ● SSL/TLS
SMTP Port	This field is for specifying the SMTP port number. By default, this is set to 25 . If Connection Security is selected " STARTTLS ", the default port number will be set to 587 . If Connection Security is selected " SSL/TLS ", the default port number will be set to 465 . You may customize the port number by editing this field.
SMTP User Name / Password	This setting specifies the SMTP username and password while sending email. These options are shown only if Require authentication is checked in the SMTP Server setting.

Confirm SMTP Password	This field allows you to verify and confirm the new administrator password.
Sender's Email Address	This setting specifies the email address which the Peplink Balance will use to send its reports.
Recipient's Email Address	This setting specifies the email address(es) to which the Peplink Balance will send email notifications. For multiple recipients, separate each email using the enter key.

After you have finished setting up email notifications, you can click the **Test Email Notification** button to test the settings before saving. After **Test Email Notification** is clicked, you will see this screen to confirm the settings:

Test Email Notification	
SMTP Server	smtp.mycompany.com
SMTP Port	465
SMTP UserName	smtpuser
Sender's Email Address	admin@mycompany.com
Recipient's Email Address	system@mycompany.com staff@mycompany.com

Click **Send Test Notification** to confirm. In a few seconds, you will see a message with detailed test results.

Test email sent.
 (NOTE: Settings are not saved. To confirm the update, click 'Save' button.)

Email Notification Setup ?	
Email Notification	<input checked="" type="checkbox"/> Enable
SMTP Server	<input type="text"/> <input checked="" type="checkbox"/> Require authentication
Connection Security	SSL/TLS (Note: any server certificate will be accepted)
SMTP Port	<input type="text" value="465"/>
SMTP User Name	<input type="text"/>
SMTP Password	<input type="password"/>
Confirm SMTP Password	<input type="password"/>
Sender's Email Address	<input type="text"/>
Recipient's Email Address	<input type="text"/>

Test Result

```
[INFO] Try email through auto detected connection
[INFO] SMTP through SSL connected
[<-] 220 smtp.gmail.com ESMTP h11sm3907691pjj.46 - gsmt
[->] EHLO balance.peplink.com
[<-] 250-smtp.gmail.com at your service, [14.192.209.255]
[<-] 250-SIZE 35882577
[<-] 250-8BITMIME
[<-] 250-AUTH LOGIN PLAIN XOAUTH2 PLAIN-CLIENTTOKEN OAUTHBEARER XOAUTH
[<-] 250-ENHANCEDSTATUSCODES
[<-] 250-PIPELINING
[<-] 250-PIPELINING
[<-] 250-CHUNKING
[<-] 250 SMTPUTF8
[->] AUTH PLAIN AGdwc2dhbjk0QGGdtYVlsLmNvbQBwdnJ6bWF6cGhtYXJpanpp
```

15.1.6 Event Log

Event log functionality enables event logging at a specified remote syslog server. The settings for configuring the remote system log can be found at **System>Event Log**.

Send Events to Remote Syslog Server ?	
Remote Syslog	<input type="checkbox"/>
Remote Syslog Host	<input type="text"/>
Port:	<input type="text" value="514"/>

Push Events to Mobile Devices ?	
Push Events	<input checked="" type="checkbox"/>

URL Logging	
Enable	<input checked="" type="checkbox"/>
Log Server Host	<input type="text"/>
Port:	<input type="text" value="514"/>

Session Logging	
Enable	<input checked="" type="checkbox"/>
Log Server Host	<input type="text"/>
Port:	<input type="text" value="514"/>

Remote Syslog Settings	
Remote Syslog	This setting specifies whether or not to log events at the specified remote syslog server.
Remote Syslog Host	This setting specifies the IP address or hostname of the remote syslog server.
Push Events	The Peplink Balance can also send push notifications to mobile devices that have our Mobile Router Utility installed. Check the box to activate this feature.
URL Logging	This setting is to enable event logging at the specified log server.
URL Logging Host	This setting specifies the IP address or hostname of the URL log server.
Session Logging	This setting is to enable event logging at the specified log server.
Session Logging Host	This setting specifies the IP address or hostname of the Session log server.
	For more information on the Router Utility, go to: www.peplink.com/products/router-utility

15.1.7 SNMP

SNMP or simple network management protocol is an open standard that can be used to collect information about the Peplink Balance unit. SNMP configuration is located at **System>SNMP**.

SNMP Settings	
SNMP Device Name	B30Pro-LTEA-IPsecNAT
Location ?	<input type="text"/>
SNMP Port	<input type="text" value="161"/> <input type="button" value="Default"/>
SNMPv1	<input type="checkbox"/> Enable
SNMPv2c	<input type="checkbox"/> Enable
SNMPv3	<input type="checkbox"/> Enable
SNMP Trap	<input checked="" type="checkbox"/> Enable
SNMP Trap Community	<input type="text"/>
SNMP Trap Server	<input type="text"/>
SNMP Trap Port	<input type="text" value="162"/>
SNMP Trap Server Heartbeat	<input type="checkbox"/>
<input type="button" value="Save"/>	

Community Name	Allowed Source Network	Access Mode
No SNMPv1 / SNMPv2c Communities Defined		
<input type="button" value="Add SNMP Community"/>		

SNMPv3 User Name	Authentication / Privacy	Access Mode
No SNMPv3 Users Defined		
<input type="button" value="Add SNMP User"/>		

SNMP Settings	
SNMP Device Name	This field shows the router name defined at System>Admin Security .
SNMP Port	This option specifies the port which SNMP will use. The default port is 161 .
SNMPv1	This option allows you to enable SNMP version 1.
SNMPv2	This option allows you to enable SNMP version 2.
SNMPv3	This option allows you to enable SNMP version 3.
SNMP Trap	This option allows you to enable SNMP Trap. If enabled, the following entry fields will

	appear.
SNMP Trap Community	This setting specifies the SNMP Trap community name.
SNMP Trap Server	Enter the IP address of the SNMP Trap server
SNMP Trap Port	This option specifies the port which the SNMP Trap server will use. The default port is 162 .
SNMP Trap Server Heartbeat	This option allows you to enable and configure the heartbeat interval for the SNMP Trap server.

To add a community for either SNMPv1 or SNMPv2, click the **Add SNMP Community** button in the **Community Name** table, upon which the following screen is displayed:

SNMP Community Settings	
Community Name	This setting specifies the SNMP community name.
Allowed Source Subnet Address	This setting specifies a subnet from which access to the SNMP server is allowed. Enter subnet address here (e.g., <i>192.168.1.0</i>) and select the appropriate subnet mask.

To define a user name for SNMPv3, click **Add SNMP User** in the **SNMPv3 User Name** table, upon which the following screen is displayed:

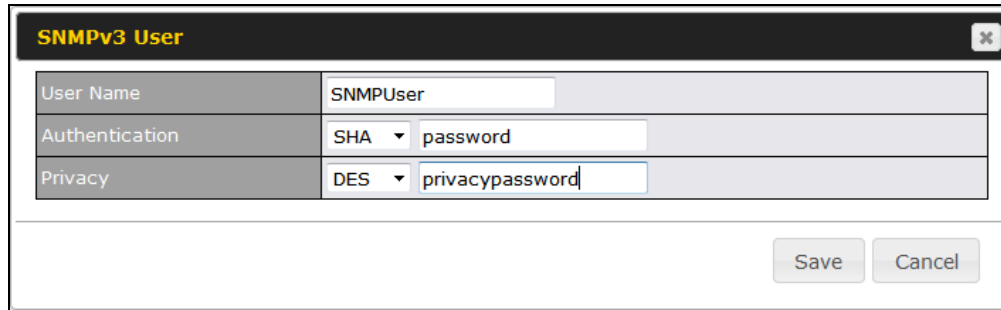

The dialog box titled "SNMPv3 User" contains the following fields:

User Name	SNMPUser
Authentication	SHA password
Privacy	DES privacypassword

Buttons: Save, Cancel

SNMPv3 User Settings	
User Name	This setting specifies a user name to be used in SNMPv3.
Authentication Protocol	<p>This setting specifies via a drop-down menu one of the following valid authentication protocols:</p> <ul style="list-style-type: none"> • NONE • MD5 • SHA <p>When MD5 or SHA is selected, an entry field will appear for the password.</p>
Privacy Protocol	<p>This setting specifies via a drop-down menu one of the following valid privacy protocols:</p> <ul style="list-style-type: none"> • NONE • DES <p>When DES is selected, an entry field will appear for the password.</p>

15.1.8 SMS Control

SMS Control allows the user to control the device using SMS even if the modem does not have a data connection. The settings for configuring the SMS Control can be found at **System>SMS Control**.

Note: Supported Models

- **Balance/MAX:** *-LTE-E, *-LTEA-W, *-LTEA-P, *-LTE-MX
- **EPX:** *-LW*, *-LP*

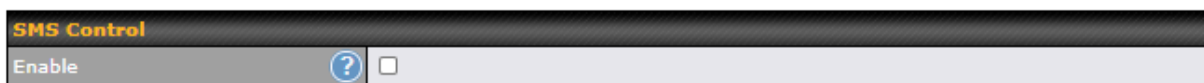

The "SMS Control" configuration box shows the "Enable" checkbox is currently unchecked.

When this box is checked, the device will be allowed to take actions according to received commands via SMS.

Make sure your mobile plan supports SMS, and note that some plans may incur additional charges for this.

SMS Control can reboot devices and configure cellular settings over signalling channels, even if the modem does not have an active data connection.

For details of supported SMS command sets, please refer to our [knowledge base](#).

SMS Control					
Enable	<input checked="" type="checkbox"/>				
Password	<input type="password"/> <input checked="" type="checkbox"/> Hide Characters				
White List	<table border="1"> <thead> <tr> <th>Phone Number</th> <th></th> </tr> </thead> <tbody> <tr> <td> </td> <td><input data-bbox="1344 499 1377 541" type="button" value="+"/></td> </tr> </tbody> </table>	Phone Number			<input data-bbox="1344 499 1377 541" type="button" value="+"/>
Phone Number					
	<input data-bbox="1344 499 1377 541" type="button" value="+"/>				

SMS Control Settings	
Enable	Click the checkbox to enable the SMS Control.
Password	This setting sets the password for authentication - maximum of 32 characters, which cannot include semicolon (;).
White List	Optionally, you can add phone number(s) to the whitelist. Only matching phone numbers are allowed to issue SMS commands. Phone numbers must be in the E.164 International Phone Numbers format.

15.1.9 InControl

Controller Management Settings	
Controller	? InControl <input type="checkbox"/> Restricted to Status Reporting Only
Privately Host InControl	<input checked="" type="checkbox"/>
InControl Host	Primary: <input type="text"/> Backup: <input type="text"/> <input type="checkbox"/> Fail over to InControl in the cloud.

Save

InControl is a cloud-based service which allows you to manage all of your Peplink and Pepwave devices with one unified system. With it, you can generate reports, gather statistics, and configure your devices automatically. All of this is now possible with InControl.

When this checkbox is checked, the device's status information will be sent to the Peplink InControl system. This device's usage data and configuration will be sent to the system if you enable the features in the system.

When the box **Restricted to Status Reporting Only** is ticked, the router will only report its status, but can't be managed or configured by InControl.

Alternatively, you can also privately host InControl. Simply check the "Privately Host InControl" box and enter the IP Address of your InControl Host. If you have multiple hosts, you may enter the primary and backup IP addresses for the InControl Host and tick the "Fail over to InControl in the cloud" box. The device will connect to either the primary InControl Host or the secondary/backup ICA/IC2.

You can sign up for an InControl account at <https://incontrol2.peplink.com/>. You can register your devices under the account, monitor their status, see their usage reports, and receive offline notifications.

15.1.10 Configuration

Backing up Peplink Balance settings immediately after successful completion of initial setup is strongly recommended. The functionality to download and upload Peplink Balance settings is found at **System>Configuration**.

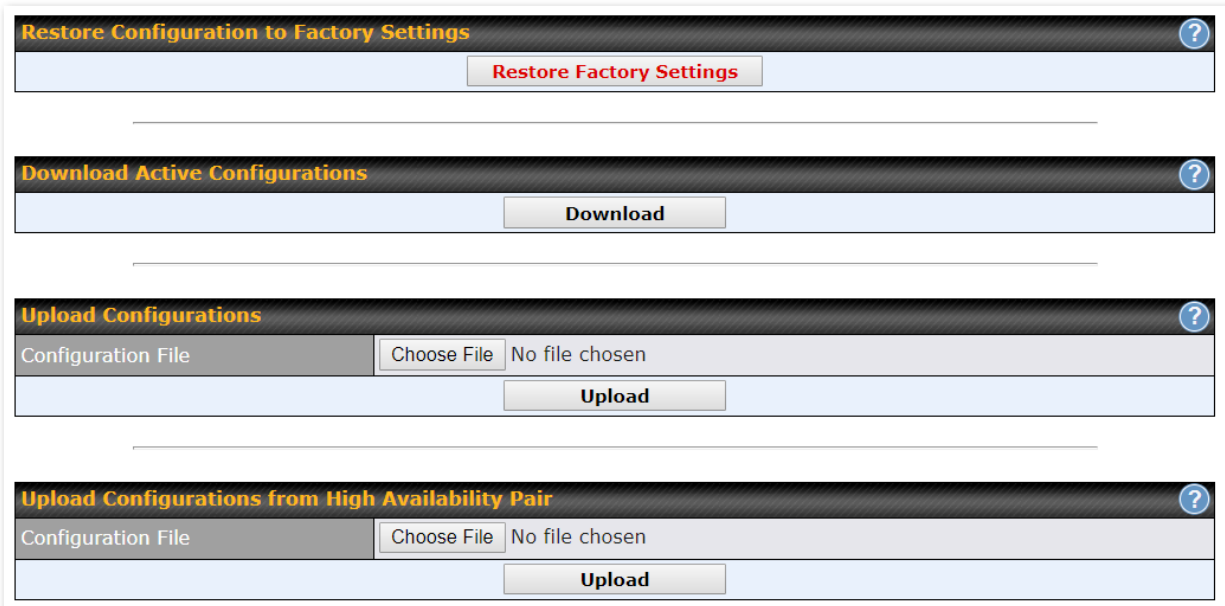

The screenshot shows the Configuration page with the following sections:

- Restore Configuration to Factory Settings**: A button labeled "Restore Factory Settings" in red text.
- Download Active Configurations**: A button labeled "Download".
- Upload Configurations**: A file selection area with a "Choose File" button and "No file chosen" text, followed by an "Upload" button.
- Upload Configurations from High Availability Pair**: A file selection area with a "Choose File" button and "No file chosen" text, followed by an "Upload" button.

Configuration	
Restore Configuration to Factory Settings	The Restore Factory Settings button is to reset the configuration to factory default settings. After clicking the button, you will need to click the Apply Changes button on the top right corner to make the settings effective.
Download Active Configurations	Click Download to backup the current active settings.
Upload Configurations	To restore or change settings based on a configuration file, click Choose File to locate the configuration file on the local computer, and then click Upload . The new settings can then be applied by clicking the Apply Changes button on the page header, or you can cancel the procedure by pressing discard on the main page of the web admin interface.
Upload Configurations from High Availability Pair	In a high availability (HA) configuration, the Balance unit can quickly load the configuration of its HA counterpart. To do so, click the Upload button. After loading the settings, configure the LAN IP address of the Peplink Balance unit so that it is different from the HA counterpart.

15.1.11 Feature Add-ons

Some balance models have features that can be activated upon purchase. Once the purchase is complete, you will receive an activation key. Enter the key in the **Activation Key** field, click **Activate**, and then click **Apply Changes**.



The screenshot shows a web interface titled "Feature Activation". It contains a label "Activation Key" on the left and a large, empty text input field on the right.

15.1.12 Reboot

This page provides a reboot button for restarting the system. For maximum reliability, the Peplink Balance Series can be equipped with two copies of firmware, and each copy can be a different version. You can select the firmware version you would like to reboot the device with. The firmware marked with **(Running)** is the current system boot up firmware.

Please note that a firmware upgrade will always replace the inactive firmware partition.

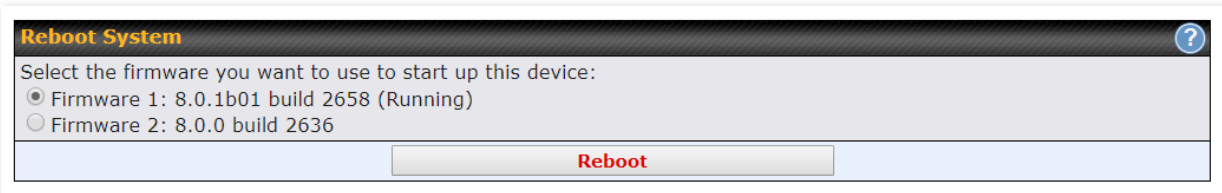

The screenshot shows a web interface titled "Reboot System" with a help icon (question mark) in the top right corner. Below the title, it says "Select the firmware you want to use to start up this device:". There are two radio button options: "Firmware 1: 8.0.1b01 build 2658 (Running)" which is selected, and "Firmware 2: 8.0.0 build 2636". At the bottom of the form is a button labeled "Reboot".

15.2 Tools

15.2.1 Ping

The ping test tool sends pings through a specific Ethernet interface or a SpeedFusion™ VPN connection. You can specify the number of pings in the field **Number of times** to a maximum number of 10 times. **Packet Size** can be set to a maximum of 1472 bytes. The ping utility is located at **System>Tools>Ping**, illustrated below:

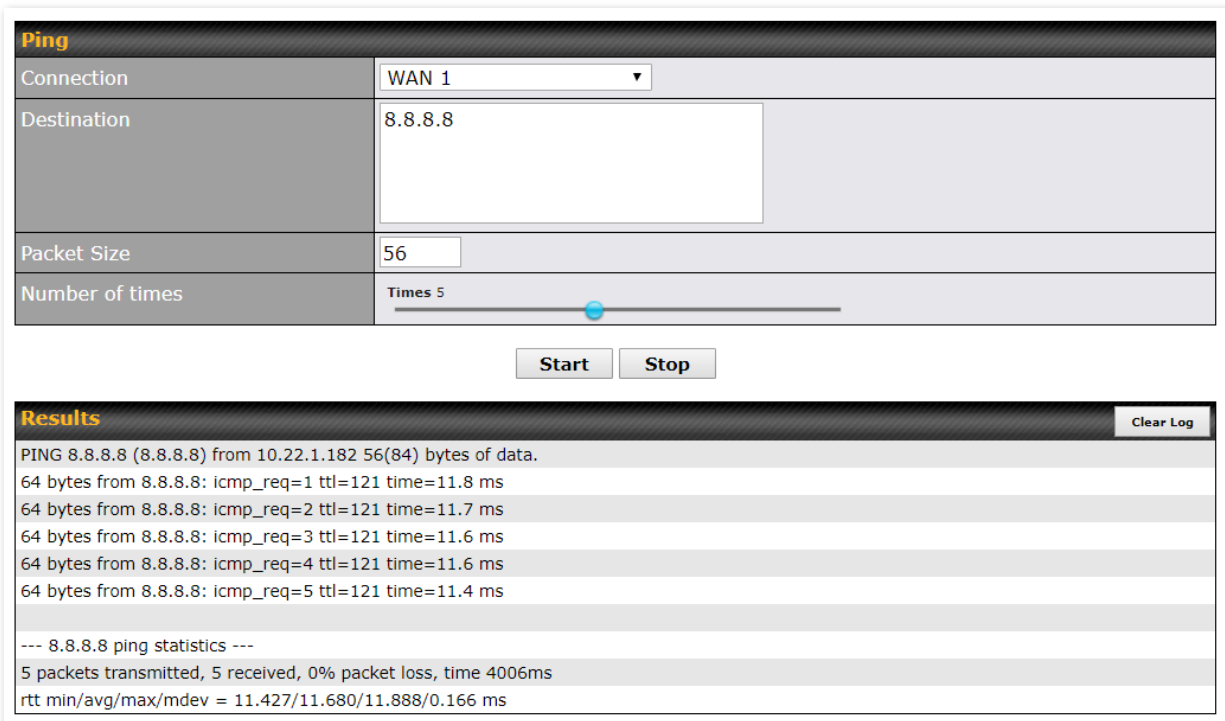

The screenshot shows the 'Ping' utility interface. It has a 'Connection' dropdown menu set to 'WAN 1', a 'Destination' text box containing '8.8.8.8', a 'Packet Size' text box containing '56', and a 'Number of times' slider set to 'Times 5'. Below these fields are 'Start' and 'Stop' buttons. The 'Results' section shows a 'Clear Log' button and the following output:

```

PING 8.8.8.8 (8.8.8.8) from 10.22.1.182 56(84) bytes of data.
64 bytes from 8.8.8.8: icmp_req=1 ttl=121 time=11.8 ms
64 bytes from 8.8.8.8: icmp_req=2 ttl=121 time=11.7 ms
64 bytes from 8.8.8.8: icmp_req=3 ttl=121 time=11.6 ms
64 bytes from 8.8.8.8: icmp_req=4 ttl=121 time=11.6 ms
64 bytes from 8.8.8.8: icmp_req=5 ttl=121 time=11.4 ms

--- 8.8.8.8 ping statistics ---
5 packets transmitted, 5 received, 0% packet loss, time 4006ms
rtt min/avg/max/mdev = 11.427/11.680/11.888/0.166 ms
    
```

Tip

A system administrator can use the ping utility to manually check the connectivity of a particular LAN/WAN connection.

15.2.2 Traceroute

The traceroute test tool traces the routing path to the destination through a particular Ethernet interface or a SpeedFusion™ connection. The traceroute test utility is located at **System>Tools>Traceroute**.

Traceroute

Connection: WAN 1

Destination: 64.233.189.99

Start Stop

Results Clear Log

Traceroute to 64.233.189.99 (64.233.189.99), 30 hops max, 30 bytes packet size

0 10.0.0.1 (10.0.0.1) 0.000 ms 0.000 ms 0.000 ms

1 10.0.0.2 (10.0.0.2) 0.000 ms 0.000 ms 0.000 ms

2 10.0.0.3 (10.0.0.3) 0.000 ms 0.000 ms 0.000 ms

3 10.0.0.4 (10.0.0.4) 0.000 ms 0.000 ms 0.000 ms

4 10.0.0.5 (10.0.0.5) 0.000 ms 0.000 ms 0.000 ms

5 10.0.0.6 (10.0.0.6) 0.000 ms 0.000 ms 0.000 ms

6 10.0.0.7 (10.0.0.7) 0.000 ms 0.000 ms 0.000 ms

7 10.0.0.8 (10.0.0.8) 0.000 ms 0.000 ms 0.000 ms

8 10.0.0.9 (10.0.0.9) 0.000 ms 0.000 ms 0.000 ms

9 10.0.0.10 (10.0.0.10) 0.000 ms 0.000 ms 0.000 ms

10 10.0.0.11 (10.0.0.11) 0.000 ms 0.000 ms 0.000 ms

11 10.0.0.12 (10.0.0.12) 0.000 ms 0.000 ms 0.000 ms

12 10.0.0.13 (10.0.0.13) 0.000 ms 0.000 ms 0.000 ms

13 10.0.0.14 (10.0.0.14) 0.000 ms 0.000 ms 0.000 ms

14 10.0.0.15 (10.0.0.15) 0.000 ms 0.000 ms 0.000 ms

15 10.0.0.16 (10.0.0.16) 0.000 ms 0.000 ms 0.000 ms

16 10.0.0.17 (10.0.0.17) 0.000 ms 0.000 ms 0.000 ms

17 10.0.0.18 (10.0.0.18) 0.000 ms 0.000 ms 0.000 ms

18 10.0.0.19 (10.0.0.19) 0.000 ms 0.000 ms 0.000 ms

19 10.0.0.20 (10.0.0.20) 0.000 ms 0.000 ms 0.000 ms

20 10.0.0.21 (10.0.0.21) 0.000 ms 0.000 ms 0.000 ms

21 10.0.0.22 (10.0.0.22) 0.000 ms 0.000 ms 0.000 ms

22 10.0.0.23 (10.0.0.23) 0.000 ms 0.000 ms 0.000 ms

23 10.0.0.24 (10.0.0.24) 0.000 ms 0.000 ms 0.000 ms

24 10.0.0.25 (10.0.0.25) 0.000 ms 0.000 ms 0.000 ms

25 10.0.0.26 (10.0.0.26) 0.000 ms 0.000 ms 0.000 ms

26 10.0.0.27 (10.0.0.27) 0.000 ms 0.000 ms 0.000 ms

27 10.0.0.28 (10.0.0.28) 0.000 ms 0.000 ms 0.000 ms

28 10.0.0.29 (10.0.0.29) 0.000 ms 0.000 ms 0.000 ms

29 10.0.0.30 (10.0.0.30) 0.000 ms 0.000 ms 0.000 ms

Tip

A system administrator can use the traceroute utility to analyze the connection path of a LAN/WAN connection.

15.2.3 Wake-on-LAN

Peplink routers can send special “magic packets” to any client specified from the Web UI. To access this feature, navigate to **System > Tools > Wake-on-LAN**

Wake-on-LAN

Wake-on-LAN Target: Custom MAC Address... 00:00:00:00:00:00 Send

Select a client from the drop-down list and click **Send** to send a “magic packet”

15.2.4 WAN Analysis

The WAN Analysis feature allows you to run a WAN to WAN speed test between 2 Peplink devices .

You can set a device up as a **Server** or a **Client**. One device must be set up as a server to run the speed tests and the server must have a public IP address.

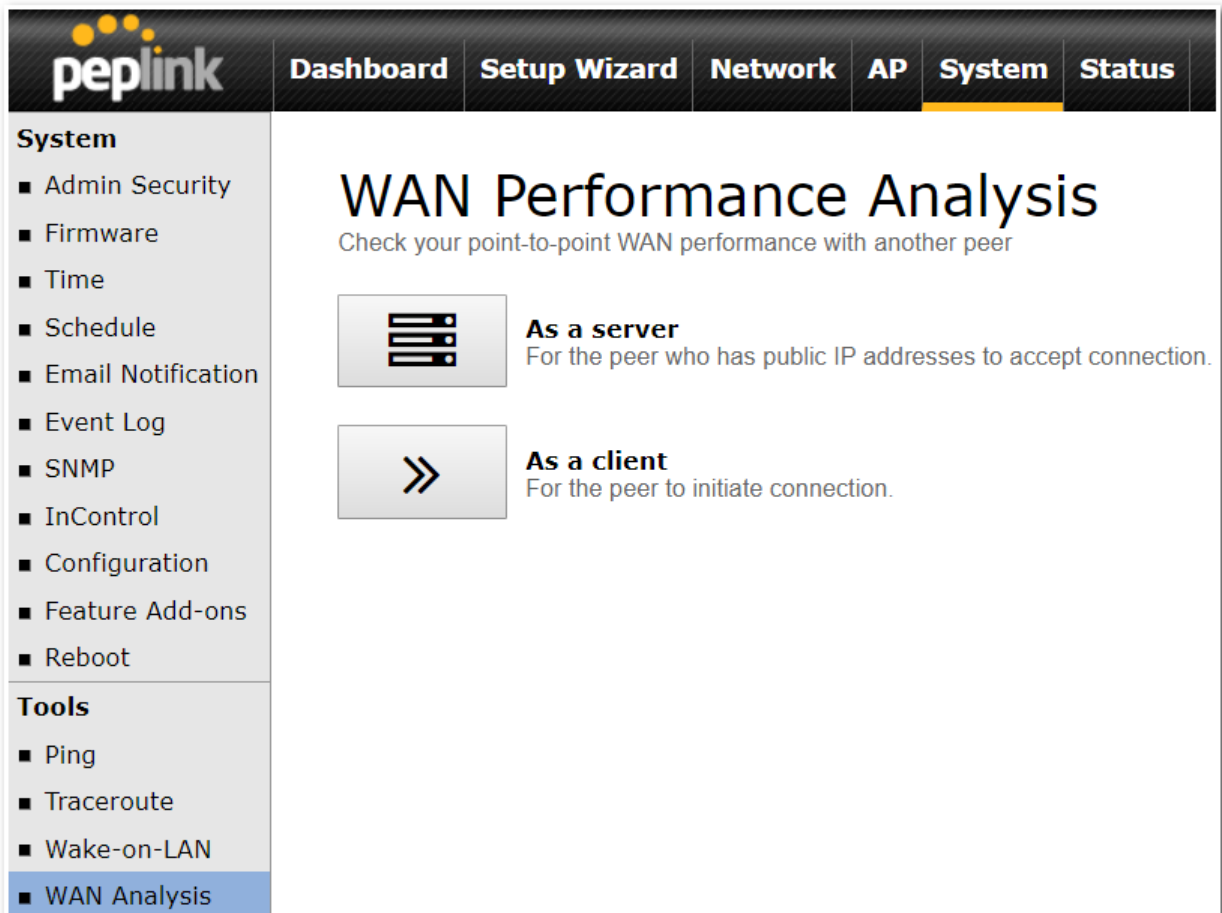

The default port is 6000 and can be changed if required. The IP address of the WAN interface will be shown in the **WAN Connection Status** section.

peplink | Dashboard | Setup Wizard | Network | AP | **System** | Status | Apply Changes

System

- Admin Security
- Firmware
- Time
- Schedule
- Email Notification
- Event Log
- SNMP
- InControl
- Configuration
- Feature Add-ons
- Reboot

Tools

- Ping
- Traceroute
- Wake-on-LAN
- WAN Analysis**

WAN Performance Analysis

Check your point-to-point WAN performance with another peer

Server Settings

Status	<input checked="" type="checkbox"/> Listening (Control Port: 6000)
Control Port	<input type="text" value="6000"/>

WAN Connection Status

1 WAN 1	<input checked="" type="checkbox"/> 10.22.1.182
2 WAN 2	<input type="checkbox"/> Disabled
3 WAN 3	<input type="checkbox"/> Disabled
4 WAN 4	<input type="checkbox"/> Disabled
5 WAN 5	<input type="checkbox"/> Disabled
Mobile Internet	<input type="checkbox"/> Disabled

The client side has a few more settings that can be changed. Make sure that the **Control Port** matches what's been entered on the server side. Select the WAN(s) that will be used for testing and enter the Servers WAN IP address. Once all of the options have been set, click the **Start Test** button.

peplink | Dashboard | Setup Wizard | Network | AP | **System** | Status | Apply Changes

System

- Admin Security
- Firmware
- Time
- Schedule
- Email Notification
- Event Log
- SNMP
- InControl
- Configuration
- Feature Add-ons
- Reboot

Tools

- Ping
- Traceroute
- Wake-on-LAN
- WAN Analysis**
- Storage Manager
- Package Manager

WAN Performance Analysis

Check your point-to-point WAN performance with another peer

Client Settings

Control Port	<input type="text" value="6000"/>
Data Port	<input type="text" value="57280"/> - <input type="text" value="57287"/>
Type	<input checked="" type="radio"/> TCP <input type="radio"/> UDP
Direction	<input checked="" type="radio"/> Upload <input type="radio"/> Download
Duration	<input type="text" value="20"/> seconds (5 - 600)

Data Streams

Local WAN Connection	Remote IP Address
1. -- Not Used --	<input type="text"/>
2. -- Not Used --	<input type="text"/>
3. -- Not Used --	<input type="text"/>
4. -- Not Used --	<input type="text"/>
5. -- Not Used --	<input type="text"/>
6. -- Not Used --	<input type="text"/>
7. -- Not Used --	<input type="text"/>
8. -- Not Used --	<input type="text"/>

The test output will show the **Data Streams Parameters**, the **Throughput** as a graph, and the **Results**.

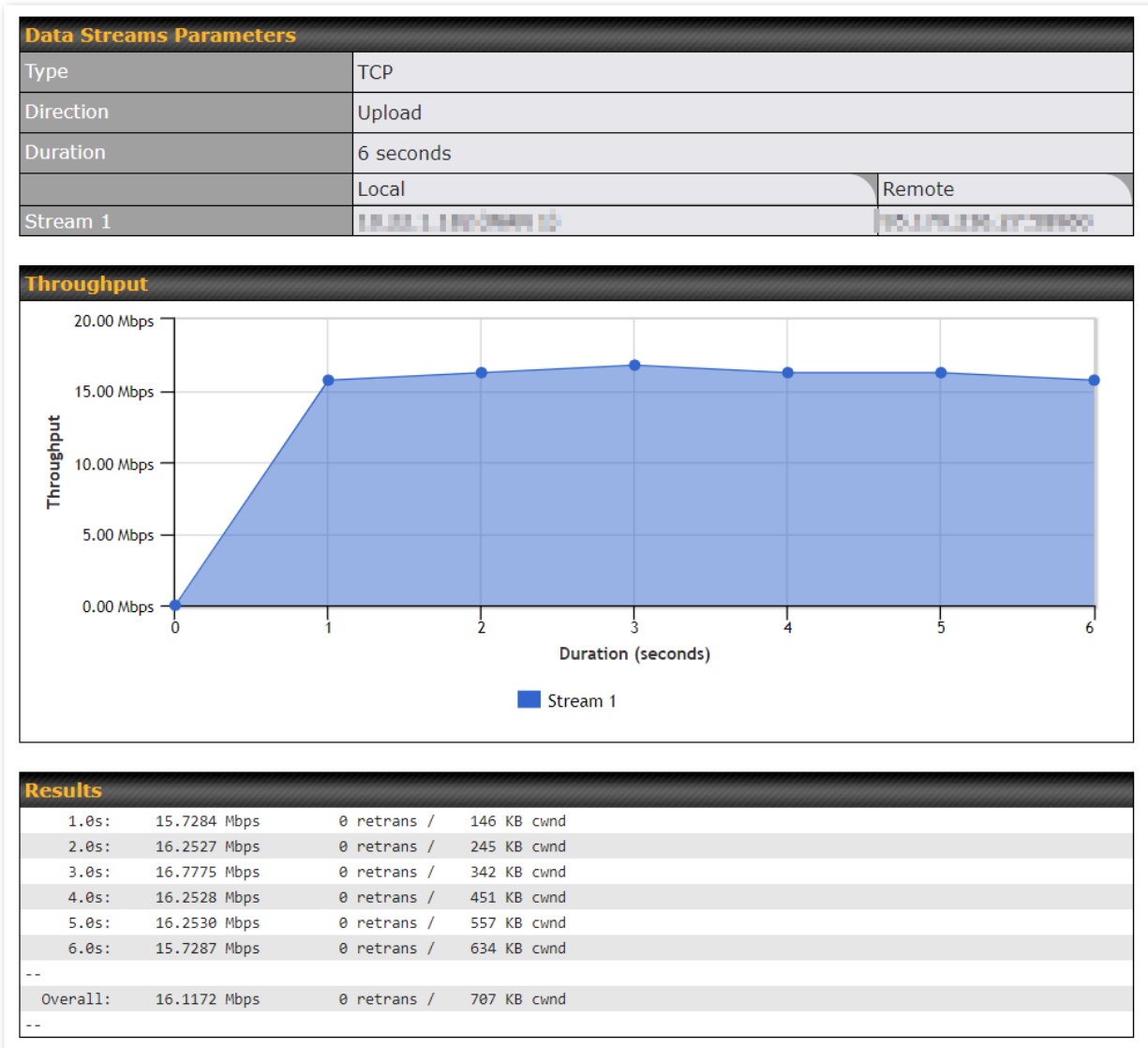

The test can be run again once it's complete by clicking the **Start** button or you can click **Close** and change the parameters for the test.

15.3 CLI (Command Line) Support

The serial console connector on some Peplink Balance units is RJ-45. To access the serial console port, prepare a RJ-45 to DB-9 console cable. Connect the RJ-45 end to the unit's console port and the DB-9 end to a terminal's serial port. The port setting will be *115200,8N1*.

The serial console connector on other Peplink Balance units is a DB-9 male connector. To access the serial console port, connect a null modem cable with a DB-9 connector on both ends to a terminal with the port setting of *115200,8N1*.

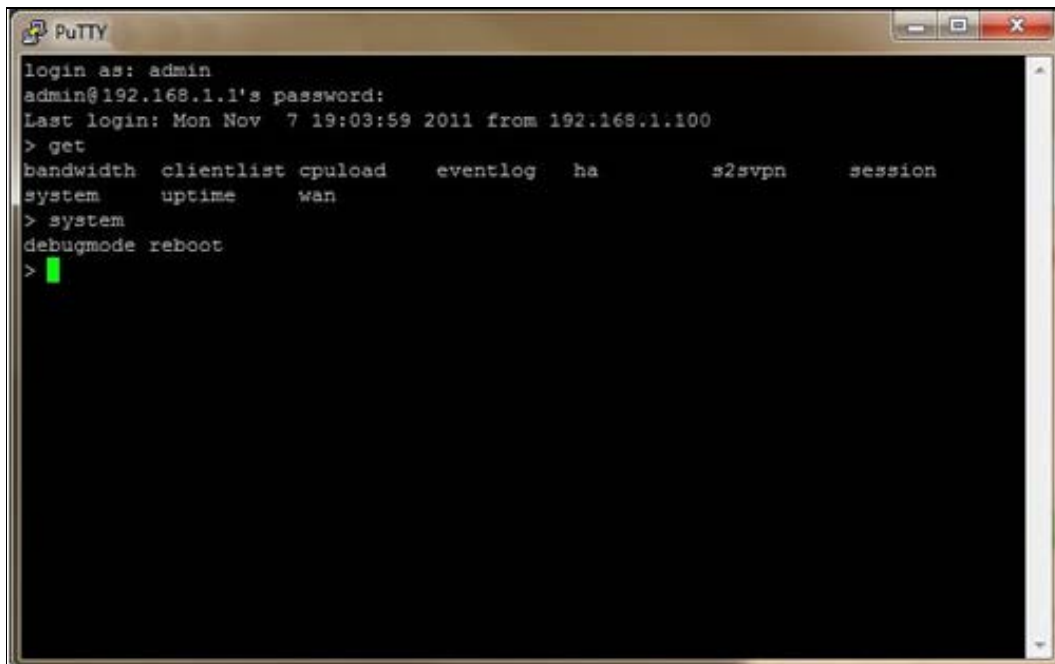

```
login as: admin
admin@192.168.1.1's password:
Last login: Mon Nov  7 19:03:59 2011 from 192.168.1.100
> get
bandwidth  clientlist  cpuload    eventlog   ha          s2svpn     session
system     uptime      wan
> system
debugmode  reboot
>
```

16 Status Tab

16.1 Status

16.1.1 Device

System information is located at **Status>Device**.

System Information	
Router Name	Mediafast 500
Model	Peplink MediaFast 500
Product Code	MFA-500-B
Hardware Revision	2
Serial Number	1001-1001-1001
Firmware	8.0.0b03 build 2593
PepVPN Version	8.0.0
Modem Support Version	1022 (Modem Support List)
Host Name	mediafast500
Uptime	54 days 23 hours 7 minutes
System Time	Wed Apr 17 14:08:23 BST 2019
Content Filtering Database	Download (r20180514) Update
Diagnostic Report	Download
Remote Assistance	Turn On

MAC Address	
LAN	10:56:00:00:00:00
WAN 1	10:56:00:00:00:00
WAN 2	10:56:00:00:00:00
WAN 3	10:56:00:00:00:00
WAN 4	10:56:00:00:00:00
WAN 5	10:56:00:00:00:00

System Information	
Router Name	This is the name specified in the Router Name field located at System>Admin Security .
Model	This shows the model name and number of this device.
Hardware Revision	This shows the hardware version of this device.
Serial Number	This shows the serial number of this device.
Firmware	This shows the firmware version this device is currently running.
Uptime	This shows the length of time since the device has been rebooted.
System Time	This shows the current system time.
Diagnostic Report	The Download link is for exporting a diagnostic report file required for system investigation.
Remote Assistance	Click Turn on to enable remote assistance.

The second table shows the MAC address of each LAN/WAN interface connected.

Important Note
If you encounter issues and would like to contact the Peplink Support Team (http://www.peplink.com/contact/), please download the diagnostic report file and attach it along with a description of your issue.

16.1.2 Active Sessions

Information on active sessions can be found at **Status>Active Sessions>Overview**.

Overview
Search

Session data captured within one minute. [Refresh](#)

Service	Inbound Sessions	Outbound Sessions
DNS	0	51
Facebook	0	1
Google	0	33
Google Ads	0	5
HTTP	0	2
IPsec	0	2
QUIC	0	19
SIP	0	8
SSH	0	3
SSL	1	136
Skype	0	6
Spotify	0	4

Interface	Inbound Sessions	Outbound Sessions
BT	1	360
Virgin Media	0	0
WAN 3	0	0
WAN 4	0	6
WAN 5	0	2
WAN 6	0	0

Top Clients

Client IP Address	Total Sessions
10.22.1.100	116
10.22.1.101	90
172.16.17.100	86
10.22.1.102	83
172.16.17.101	73

This screen displays the number of sessions initiated by each application. Click on each service listing for additional information. This screen also indicates the number of sessions initiated by each WAN port. Finally, you can see which clients are initiating the most sessions.

In addition, you can also perform a filtered search for specific sessions. You can filter by subnet, port, protocol, and interface. To perform a search, navigate to **Status>Active Sessions>Search**.

Overview
Search

Session data captured 2 mins ago. [Refresh](#)

IP / Subnet	Source or Destination ▾	/ 255.255.255.255 (/32) ▾
Port	Source or Destination ▾	
Protocol / Service	Spotify ▾	
Interface	<input type="checkbox"/> 1 BT <input type="checkbox"/> 2 Virgin Media <input type="checkbox"/> 3 WAN 3 <input type="checkbox"/> 4 WAN 4 <input type="checkbox"/> 5 Peplink HK Net... <input type="checkbox"/> 📶 Mobile Internet <input type="checkbox"/> 🛡️ VPN	
Search		

Outbound

Protocol	Source IP	Destination IP	Service	Interface	Idle Time
TCP	10.10.10.10:58827	104.199.64.136:443	SSL/Spotify	BT	00:00:09
TCP	10.10.10.10:58828	104.199.64.136:443	SSL/Spotify	BT	00:00:09
TCP	10.10.10.10:58784	35.186.224.47:443	SSL/Spotify	BT	00:00:10
TCP	10.10.10.10:65369	35.186.224.53:443	SSL/Spotify	BT	00:00:29

Total searched results: 4

Inbound

Protocol	Source IP	Destination IP	Service	Interface	Idle Time
No sessions					

Total searched results: 0

Transit

Protocol	Source IP	Destination IP	Service	Interface	Idle Time
No sessions					

Total searched results: 0

This **Active Sessions** section displays the active inbound / outbound sessions of each WAN connection on the Peplink Balance. A filter is available to help sort out the active session information. Enter a keyword in the field or check one of the WAN connection boxes for filtering.

16.1.3 Client List

The client list table is located at **Status>Client List**. It lists DHCP and online client IP addresses, type, names (retrieved from the DHCP reservation table or defined by users), current download and upload rate, and MAC address.

Clients can be imported into the DHCP reservation table by clicking the button on the right. Further update the record after the import by going to **Network>LAN**.

Filter

Online Clients Only
 DHCP Clients Only

Client List
?

	IP Address ▲	Type	Name	Download (kbps)	Upload (kbps)	MAC Address	Network Name (SSID)	Signal (dBm)	
	192.168.50.10		LAPTOP-██████████	32	85	██████████	PEPWAVE_██████	-57	
	192.168.50.12		max-hd2-██████	0	3	██████████			

Scale: kbps Mbps

If the PPTP server SpeedFusion™, or AP controller is enabled, you may see the corresponding connection name listed in the **Name** field.

In the client list table, there is a “Ban Client” feature which is used to disconnect the Wi-Fi and Remote User Access clients by clicking the button on the right.

Filter

Online Clients Only
 DHCP Clients Only

Client List
?

	IP Address ▲	Type	Name	Download (kbps)	Upload (kbps)	MAC Address	Network Name (SSID)	Signal (dBm)	
	192.168.50.10		LAPTOP-██████████	279	14	██████████	PEPWAVE_██████	-52	
	192.168.50.12		max-hd2-██████	0	0	██████████			

Scale: kbps Mbps

There is a blocklist on the same page after you banned the Wi-Fi or Remote User Access clients.

Filter

Online Clients Only
 DHCP Clients Only

[Access restriction](#) in action, some clients are currently banned.

Client List
?

IP Address ▲	Name	Download (kbps)	Upload (kbps)	MAC Address	Network Name (SSID)	Signal (dBm)

You may also unblock the Wi-Fi or Remote User Access clients when the client devices need to reconnect the network by clicking  the button on the right.

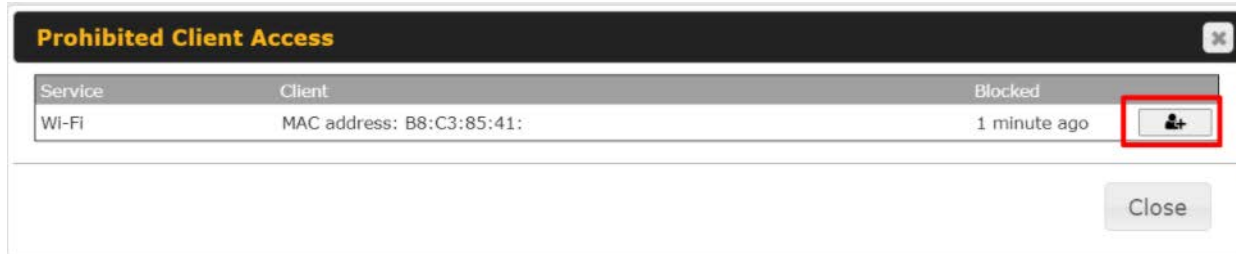

16.1.4 WINS Clients

The WINS client list table is located at **Status>WINS Client**.

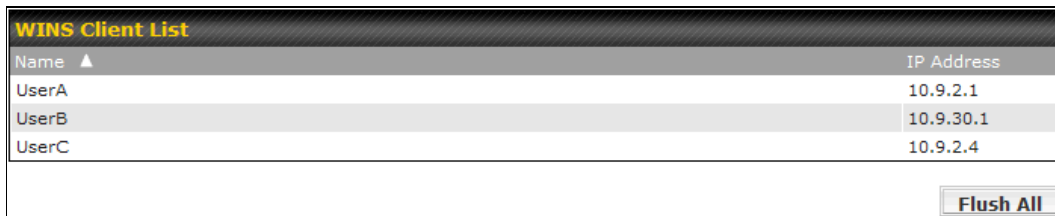

The WINS client table lists the IP addresses and names of WINS clients. This option will only be available when you have enabled the WINS server. The names of clients retrieved will be automatically matched into the Client List (see previous section). Click **Flush All** to flush all WINS client records.

16.1.5 OSPF & RIPv2

Information on OSPF and RIPv2 routing setup can be found at **Status>OSPF & RIPv2**.

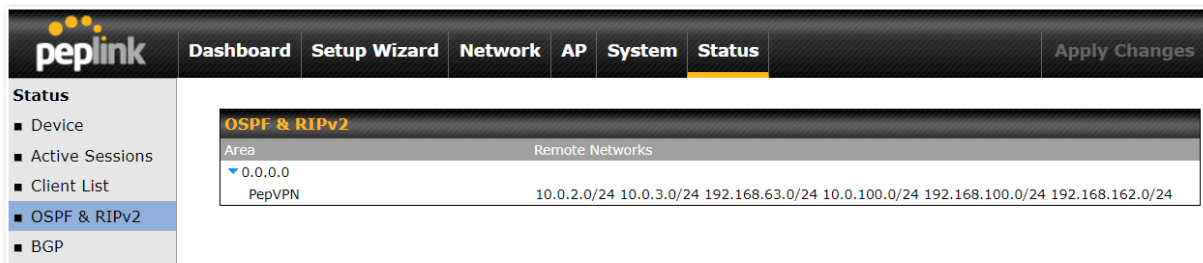

16.1.6 MediaFast

To get details on storage and bandwidth usage, select **Status>MediaFast**.

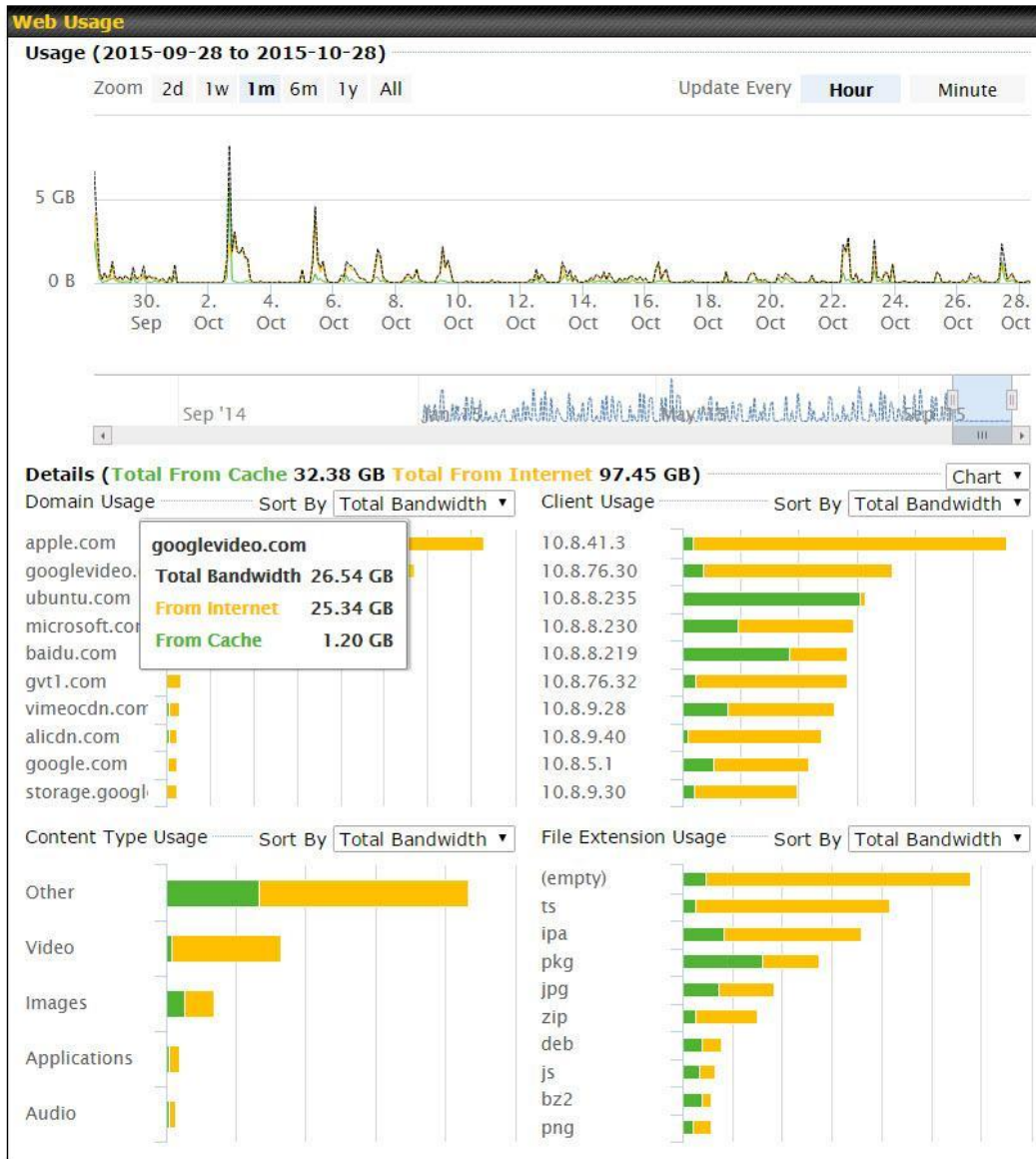

16.1.7 PepVPN / SpeedFusion Status

PepVPN/SpeedFusion Status shows the current connection status of each connection profile and is displayed at **Status> PepVPN/SpeedFusion**.

Remote Peer	Profile	Information
MAX-BR1-1000 (1000-1000-1000-1000)	None	SpeedFusion Cloud WAN1: 0.0 kbps WAN2: 0.0 kbps
MAX-BR1-1000 (1000-1000-1000-1000)	None	SpeedFusion Cloud WAN1: 0.0 kbps WAN2: 0.0 kbps

Click on the corresponding peer name to explore the WAN connection(s) status and subnet information of each VPN peer.

Remote Peer	Profile	Information
SFC-SIN-001 (SFC-SIN-001)	SFC	SpeedFusion Cloud
WAN1		Not available - WAN disabled
WAN2	Rx: < 1 kbps Tx: < 1 kbps	Loss rate: 0.0 pkt/s Latency: 42 ms
WAN3	Rx: < 1 kbps Tx: < 1 kbps	Loss rate: 0.0 pkt/s Latency: 42 ms
WAN4		Not available - WAN disabled
WAN5	Rx: < 1 kbps Tx: < 1 kbps	Loss rate: 0.0 pkt/s Latency: 10 ms
Mobile Internet	Rx: < 1 kbps Tx: < 1 kbps	Loss rate: 0.0 pkt/s Latency: 32 ms
Total	Rx: < 1 kbps Tx: 1.1 kbps	Loss rate: 0.0 pkt/s

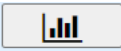
Click the  button for PepVPN/SpeedFusion chart displaying real-time throughput, latency, and drop-rate information for each WAN connection.

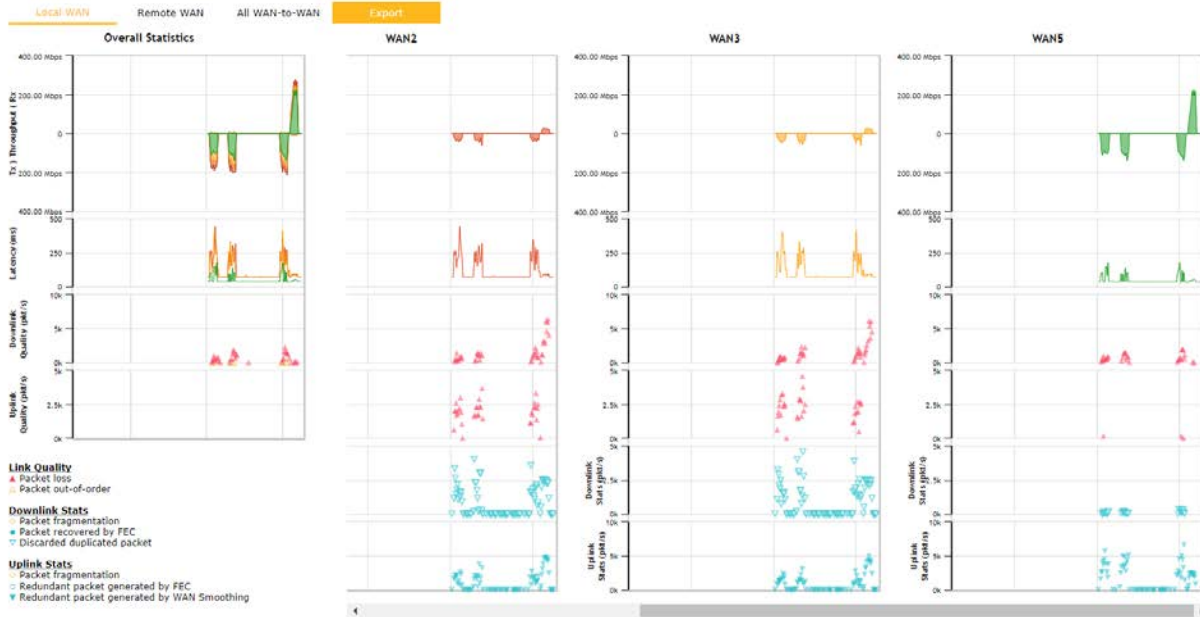

When pressing the  button for a PepVPN/SpeedFusion Tunnel Bandwidth Test Tool, the following menu will appear:

PepVPN Details ✕

Connection Information More information

Profile	SFC
Remote ID	SFC-SIN-001
Device Name	SFC-SIN-001
Serial Number	1197-A047-2E3D

WAN Statistics 📊

Remote Connections	<input type="checkbox"/> Show remote connections				
WAN Label	<input checked="" type="radio"/> WAN Name <input type="radio"/> IP Address and Port				
<input type="checkbox"/> WAN1	Not available - WAN disabled				
<input checked="" type="checkbox"/> WAN2	Rx: < 1 kbps	Tx: < 1 kbps	Loss rate: 0.0 pkt/s	Latency: 43 ms	
<input checked="" type="checkbox"/> WAN3	Rx: < 1 kbps	Tx: < 1 kbps	Loss rate: 0.0 pkt/s	Latency: 44 ms	
<input type="checkbox"/> WAN4	Not available - WAN disabled				
<input checked="" type="checkbox"/> WAN5	Rx: < 1 kbps	Tx: < 1 kbps	Loss rate: 0.0 pkt/s	Latency: 10 ms	
<input checked="" type="checkbox"/> Mobile Internet	Rx: < 1 kbps	Tx: < 1 kbps	Loss rate: 0.0 pkt/s	Latency: 42 ms	
Total	Rx: < 1 kbps	Tx: < 1 kbps	Loss rate: 0.0 pkt/s		

PepVPN Test Configuration ?

Type	<input checked="" type="radio"/> TCP <input type="radio"/> UDP	<div style="border: 1px solid #ccc; padding: 5px; width: 40px; margin: 0 auto;">Start</div>
Streams	4 ▼	
Direction	<input checked="" type="radio"/> Upload <input type="radio"/> Download	
Duration	20 seconds (5 - 600)	

The **connection information** shows the details of the selected PepVPN profile, consisting of the Profile name, **Router ID**, **Router Name** and **Serial Number** of the remote router. Advanced features for the PepVPN profile will also be shown when the **More Information** checkbox is selected.

The **WAN statistics** show information about the local and remote WAN connections (when **show Remote connections**) is selected.

The available details are **WAN Name**, **IP address** and **port** used for the Speedfusion connection. **Rx and Tx rates**, **Loss rate** and **Latency**.

Connections can be temporarily disabled by sliding the switch button next to a WAN connection to the left.

The wan-to-wan connection disabled by the switch is temporary and will be re-enabled after 15 minutes without any action.

This can be used when testing the PepVPN speed between two locations to see if there is interference or network congestion between certain WAN connections.

WAN Statistics	
Remote Connections	<input checked="" type="checkbox"/> Show remote connections
WAN Label	<input checked="" type="radio"/> WAN Name <input type="radio"/> IP Address and Port
<div style="display: flex; align-items: center;"> <div style="margin-right: 10px;">■ BT</div> <div style="margin-right: 10px;"><input type="checkbox"/> WAN</div> <div style="margin-right: 10px;">■ Virgin Media</div> </div>	
Rx:	< 1 kbps
Tx:	< 1 kbps
Loss rate:	0.0 pkt/s
Latency:	17 ms
Not available - WAN disabled	

The PepVPN/SpeedFusion test configuration allows us to configure and perform thorough tests. This is usually done after the initial installation of the routers and in case there are problems with aggregation.

PepVPN Test Configuration	
Type	<input checked="" type="radio"/> TCP <input type="radio"/> UDP
Streams	4 ▼
Direction	<input checked="" type="radio"/> Upload <input type="radio"/> Download
Duration	20 seconds (5 - 600)
<div style="border: 1px solid gray; padding: 5px; width: 60px; float: right;">Start</div>	

Press the Start button to perform throughput test according to the configured options.

If TCP is selected, 4 parallel streams will be generated to get the optimal results by default. This can be customized by selecting a different value of streams.

Using more streams will typically get better results if the latency of the tunnel is high.

PepVPN Test Results			
1.0s:	14.6724 Mbps	0 retrans /	323 KB cwnd
2.0s:	15.1620 Mbps	0 retrans /	416 KB cwnd
3.0s:	15.2438 Mbps	0 retrans /	513 KB cwnd
4.0s:	16.2522 Mbps	0 retrans /	609 KB cwnd
5.0s:	14.6811 Mbps	0 retrans /	699 KB cwnd
6.0s:	15.2058 Mbps	0 retrans /	804 KB cwnd
7.0s:	15.7294 Mbps	0 retrans /	935 KB cwnd
8.0s:	15.2053 Mbps	0 retrans /	1024 KB cwnd
9.0s:	15.6881 Mbps	0 retrans /	1045 KB cwnd
10.0s:	14.7147 Mbps	0 retrans /	1045 KB cwnd
--			
Stream 1:	4.0414 Mbps	0 retrans /	254 KB cwnd
Stream 2:	4.2783 Mbps	0 retrans /	253 KB cwnd
Stream 3:	2.8789 Mbps	0 retrans /	285 KB cwnd
Stream 4:	4.1534 Mbps	0 retrans /	253 KB cwnd
--			
Overall:	15.3520 Mbps	0 retrans /	1045 KB cwnd
--			
TEST DONE			

16.1.8 Event Log

Event log information is located at **Status>Event Log**.

Device Event Log

The screenshot shows the 'Device Event Log' interface. At the top, there are two tabs: 'Device Event Log' (selected) and 'ContentHub Event Log'. Below the tabs is a header for 'Device Event Log' with an 'Auto Refresh' checkbox checked. The log contains a list of events with the following details:

Timestamp	Event Description
Apr 17 14:54:52	System: IPsec: Amazon Singapore/1x1 - Initiating Main Mode connection...
Apr 17 14:39:44	System: IPsec: Amazon Singapore/1x1 - Initiating Main Mode connection...
Apr 17 09:12:42	System: Changes applied
Apr 17 09:07:33	Admin: Remote web admin initiated from [Control 2] by [admin@peplink.com]
Apr 16 10:01:13	System: IPsec: Amazon Singapore/1x1 - Initiating Main Mode connection...
Apr 16 10:00:23	System: Changes applied
Apr 16 09:59:04	System: Changes applied
Apr 16 09:58:57	IPsec: Main Mode disconnected [Closed]
Apr 16 09:57:10	System: IPsec: Amazon Singapore/1x1 - Initiating Main Mode connection...
Apr 16 09:57:04	System: Changes applied
Apr 16 09:56:16	Web Blocking: An update for Web Blocking DB is available.
Apr 16 09:56:15	System: IPsec: Amazon Singapore/1x1 - Initiating Main Mode connection...
Apr 16 09:56:15	System: IPsec: Amazon Singapore/1x1 - Initiating Main Mode connection...
Apr 16 09:56:13	System: Changes applied
Apr 16 09:54:41	Admin: admin [192.168.1.100] login successful
Apr 16 09:50:28	System: IPsec: Amazon Singapore/1x1 - Initiating Main Mode connection...
Apr 16 09:50:28	System: IPsec: Amazon Singapore/1x1 - Initiating Main Mode connection...

At the bottom left of the log area, there is a 'Clear Log' button.

The log section displays a list of events that have taken place on the Peplink Balance unit. Check **Auto Refresh** to refresh log entries automatically. Click the **Clear Log** button to clear the log.

IPsec Event Log

The screenshot shows the 'IPsec VPN Event Log' interface. At the top, there are two tabs: 'Device Event Log' and 'IPsec VPN Event Log' (selected). Below the tabs is a header for 'IPsec VPN Event Log' with an 'Auto Refresh' checkbox checked. The log contains a list of events with the following details:

Timestamp	Event Description
Dec 30 08:32:26	IPsec: Amazon Singapore/1x1 - Initiating Main Mode connection...
Dec 30 08:31:46	IPsec: Amazon Singapore/1x1 - Initiating Main Mode connection...
Sep 04 01:01:29	IPsec: Amazon Singapore/1x1 - Initiating Main Mode connection...

At the bottom right of the log area, there is an 'End of log' indicator.

This section displays a list of events that have taken place within an IPsec VPN connection.

Check the box next to **Auto Refresh** and the log will be refreshed automatically.
For an AP event log, navigate to **AP > Info**.

16.2 WAN Quality

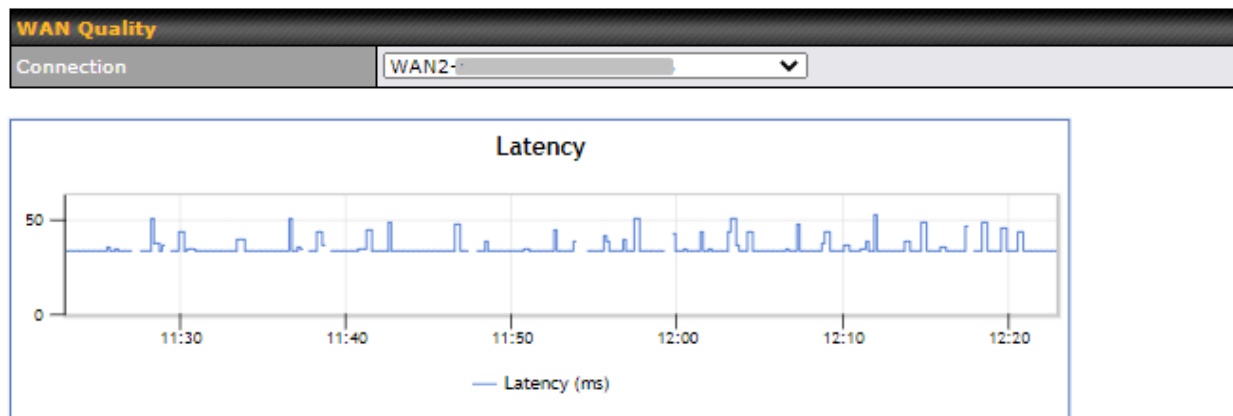

The **Status > WAN Quality** allows to show detailed information about each connected WAN connection.

16.3 Usage Reports

This section shows the bandwidth usage statistics, located at **Status > Bandwidth**. Bandwidth usage at the LAN while the device is switched off (e.g., LAN bypass) is neither recorded nor shown.

16.3.1 Real-Time

The **Data transferred since installation** table indicates how much network traffic has been processed by the device since the first bootup. The **Data transferred since last reboot** table indicates how much network traffic has been processed by the device since the last bootup.

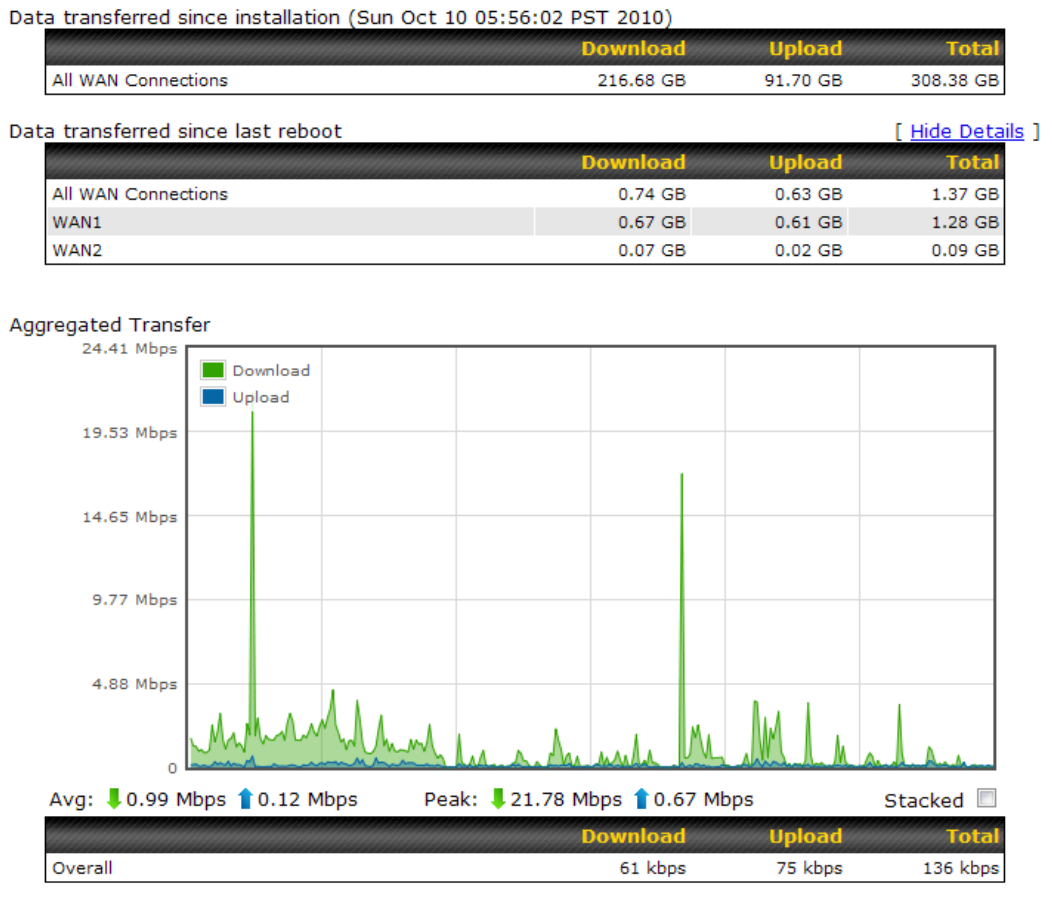

16.3.2 Hourly

This page shows the hourly bandwidth usage for all WAN connections, with the option of viewing each individual connection. Select the desired connection to check from the drop-down menu.

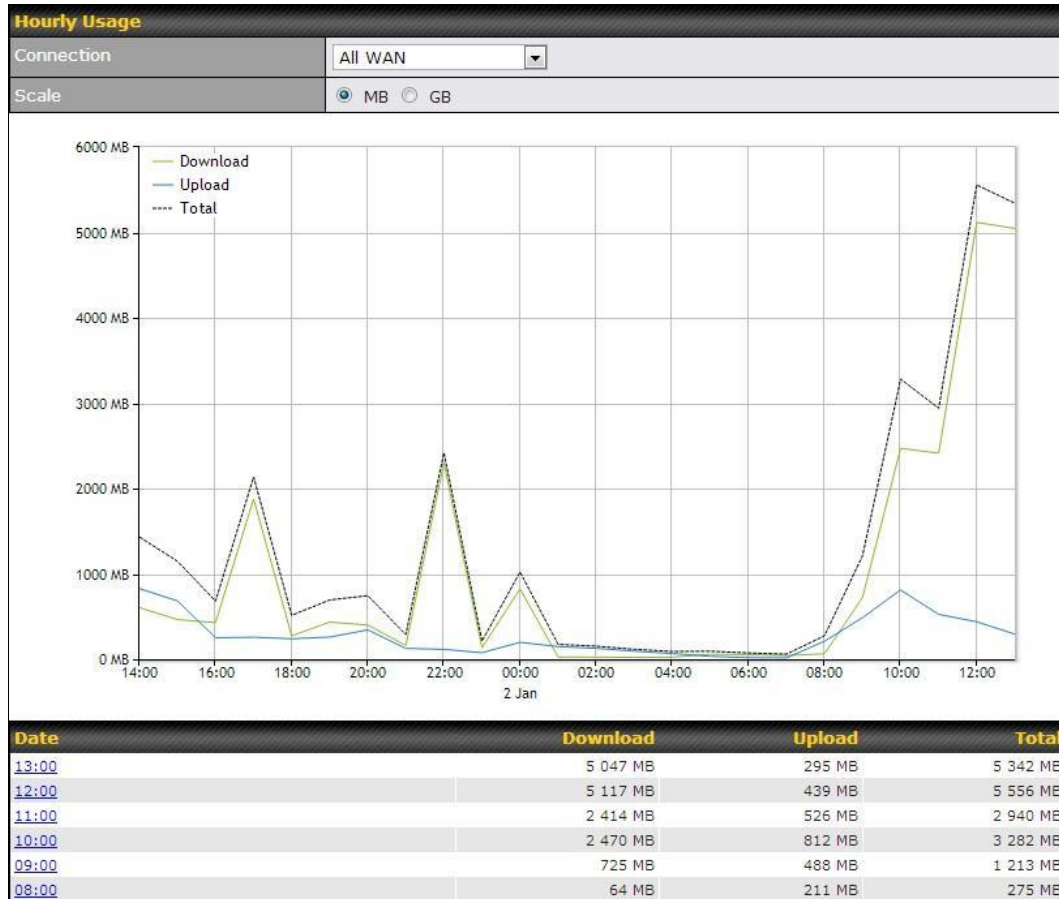

16.3.3 Daily

This page shows the daily bandwidth usage for all WAN connections, with the option of viewing each individual connection.

Select the connection to check from the drop-down menu. If you have enabled the **Bandwidth Monitoring** feature as shown in **Section 13.4**, the **Current Billing Cycle** table for that WAN connection will be displayed.

Click on a date to view the client bandwidth usage of that specific date. This feature is not available if you have selected to view the bandwidth usage of only a particular WAN connection. The scale of the graph can be set to display megabytes (**MB**) or gigabytes (**GB**).



Status

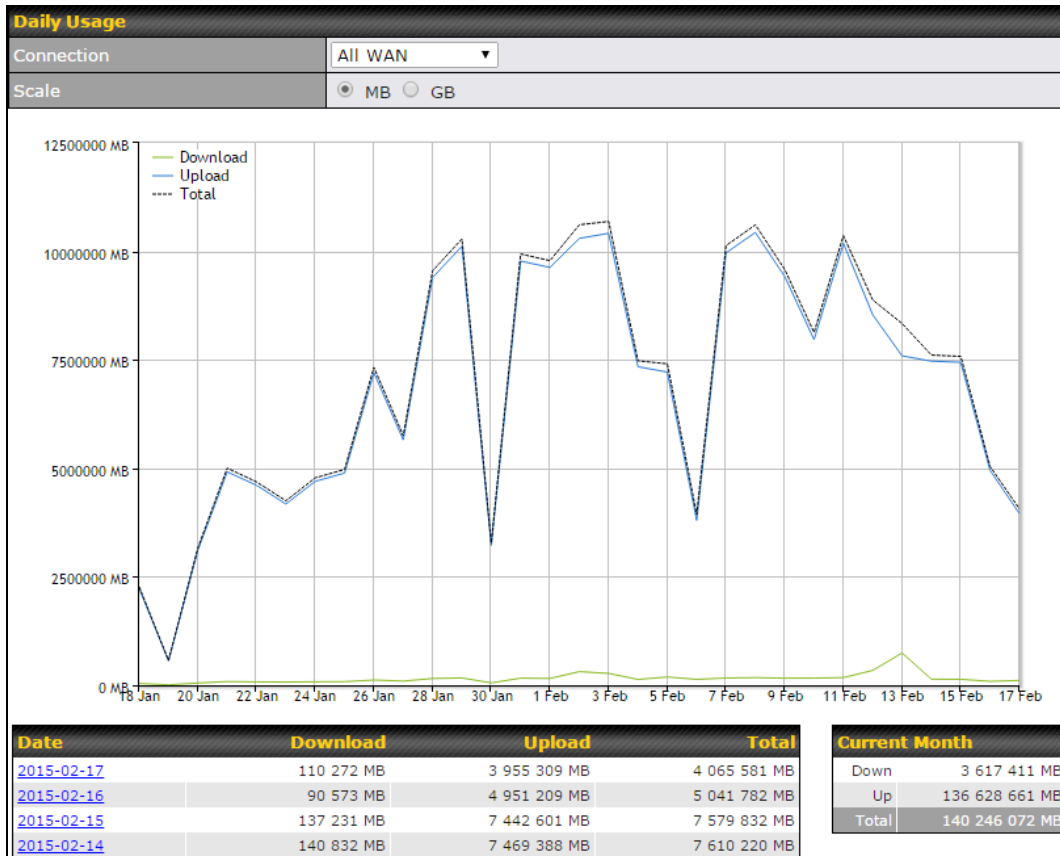

Click on a specific date to receive a breakdown of all client usage for that date.

Client Bandwidth Usage (2015-02-15)

IP Address	Type	Download	Upload	Total
192.168.168.15	LAN Client	7 972.69 MB	1 217 122.81 MB	1 225 095.50 MB
192.168.168.14	LAN Client	7 432.25 MB	1 197 380.53 MB	1 204 812.79 MB
192.168.168.22	LAN Client	5 676.90 MB	617 109.49 MB	622 786.39 MB
192.168.168.21	LAN Client	5 693.38 MB	615 629.07 MB	621 322.46 MB
192.168.168.12	LAN Client	2 156.79 MB	339 779.46 MB	341 936.25 MB
192.168.168.16	LAN Client	2 107.10 MB	333 980.14 MB	336 087.23 MB
192.168.168.18	LAN Client	16.75 MB	9.50 MB	26.25 MB
192.168.167.14	LAN Client	4.74 MB	8.35 MB	13.09 MB
192.168.167.13	LAN Client	4.73 MB	8.35 MB	13.08 MB
192.168.168.19	LAN Client	0.02 MB	0.02 MB	0.03 MB
192.168.168.20	LAN Client	0.00 MB	0.00 MB	0.00 MB
192.168.168.11	LAN Client	0.00 MB	0.00 MB	0.00 MB

16.3.4 Monthly

This page shows the monthly bandwidth usage for each WAN connection. If you have enabled **Bandwidth Monitoring** feature as shown in **Section 13.4**, you can check the usage of each particular connection and view the information by **Billing Cycle** or by **Calendar Month**.

Click the first two rows to view the client bandwidth usage in the last two months. This feature is not available if you have chosen to view the bandwidth of an individual WAN connection. The scale of the graph can be set to display megabytes (**MB**) or gigabytes (**GB**).

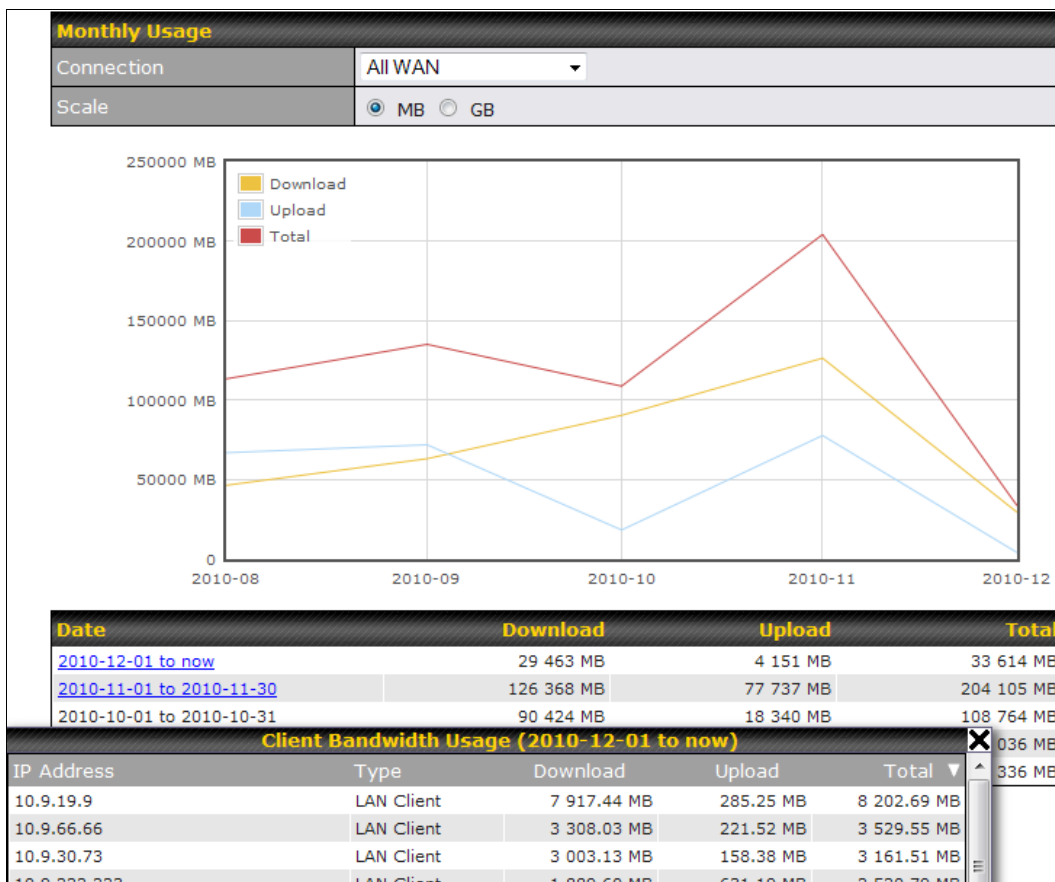

Click on a specific month to receive a breakdown of all client usage for that month.

Appendix

Appendix A. Restoration of Factory Defaults

To restore the factory default settings on a Peplink Balance unit, perform the following:

For Balance models with a reset button:

1. Locate the reset button on the Peplink Balance unit.
2. With a paperclip, press and keep the reset button pressed.

Hold for 5-10 seconds for admin password reset (Note: The LED status light blinks in RED 2 times and release the button, green status light starts blinking)

Hold for approximately 20 seconds for factory reset (Note: The LED status light blinks in RED 3 times and release the button, all WAN/LAN port lights start blinking)

After the Peplink Balance router finishes rebooting, the factory default settings will be restored.

For Balance/MediaFast models with an OLED menu:

- Use the buttons on the front panel to control the OLED menu to go to **Maintenance>Factory Defaults**, and then choose **Yes** to confirm.

Afterwards, the factory default settings will be restored.

Important Note

All previous configurations and bandwidth usage data will be lost after restoring factory default settings. Regular backup of configuration settings is strongly recommended.

Appendix B. Routing under DHCP, Static IP, and PPPoE

The information in this appendix applies only to situations where the Peplink Balance operates a WAN connection under DHCP, Static IP, or PPPoE.

B.1 Routing Via Network Address Translation (NAT)

When the Peplink Balance is operating under NAT mode, the source IP addresses of outgoing IP packets are translated to the WAN IP address of the Peplink Balance. With NAT, all LAN devices share the same WAN IP address to access the Internet (i.e., the WAN IP address of the Peplink Balance).

Operating the Peplink Balance in NAT mode requires only one WAN (Internet) IP address. In addition, operating in NAT mode also has security advantages because LAN devices are hidden behind the Peplink Balance. They are not directly accessible from the Internet and hence less vulnerable to attacks.

The following figure shows the packet flow in NAT mode:

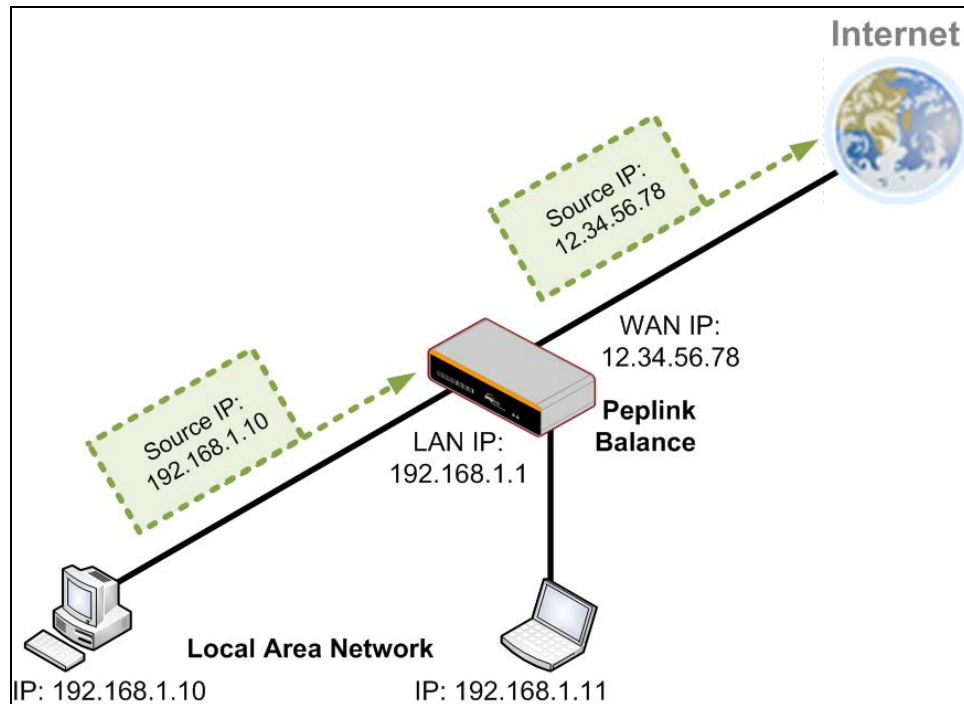

B.2 Routing Via IP Forwarding

When the Peplink Balance is operating under IP forwarding mode, the IP addresses of IP packets are unchanged; the Peplink Balance forwards both inbound and outbound IP packets without changing their IP addresses.

The following figure shows the packet flow in IP forwarding mode:

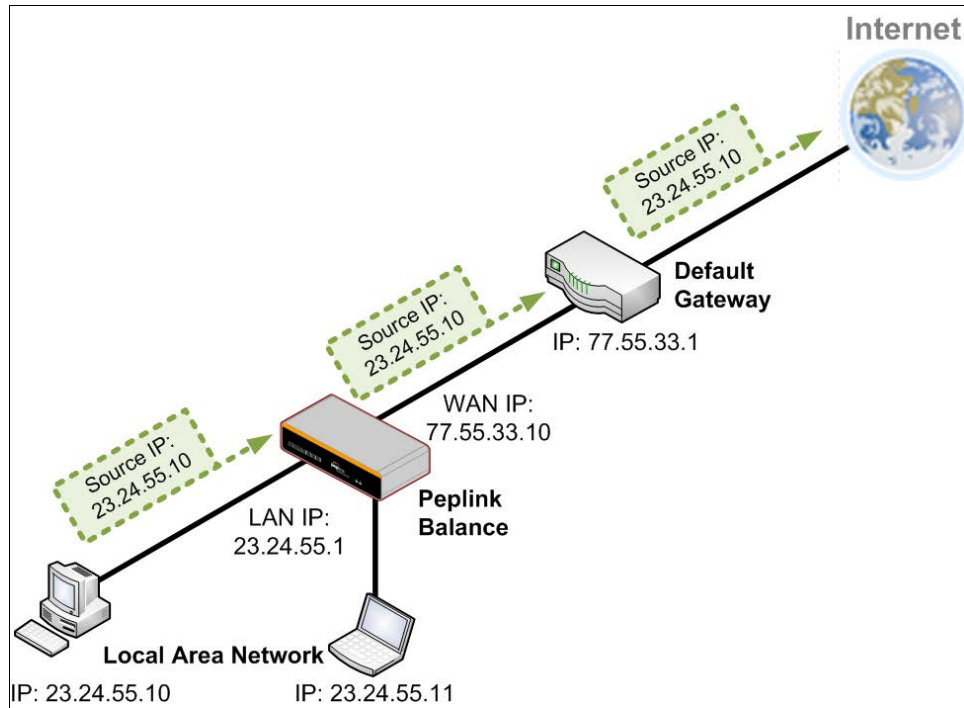

Appendix C. FusionSIM Manual

Peplink has developed a unique technology called FusionSIM, which allows SIM cards to remotely link to a cellular router. This can be done via cloud or within the same physical network. There are a few key scenarios to fit certain applications.

The purpose of this manual is to provide an introduction on where to start and how to set up for the most common scenarios and uses.

Requirements

1. A Cellular router that supports FusionSIM technology
2. SIM Injector
3. SIM card

Notes:

- Always check for the latest [Firmware version](#) for both the cellular router and the SIM Injector. You can also check for the latest Firmware version on the device's WEB configuration page.
- A list of products that support FusionSIM can be found on the SIM Injector [WEB page](#). Please check under the section **Supported models**.

SIM Injector reset and login details

How to reset a SIM Injector:

- Hold the reset button for 5-10 seconds. Once the LED status light turns RED, the reset button can be released. SIM Injector will reboot and start with the factory default settings.

The default WEB login settings:

- **User:** admin
- **Password:** admin
- IP address: the device only has a DHCP client and no fallback IP address. Therefore, it is advised to check every time what IP address is assigned to the SIM Injector.

Notes:

- The SIM Injector can be monitored via InControl 2. Configuration is not supported.

Scenario 1: SIM Injector in LAN of Cellular Router

Setup topology

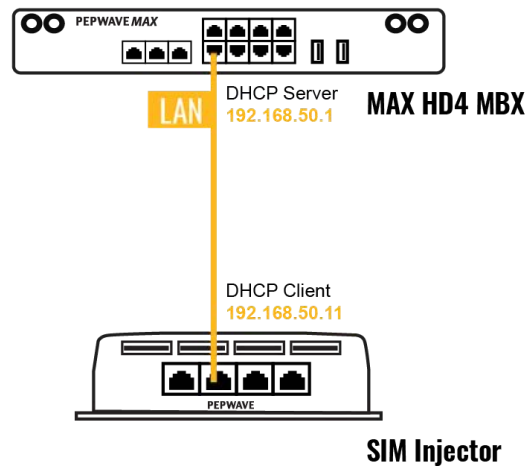

This is the most basic scenario in which the SIM Injector is connected directly to the cellular router's LAN port via an ethernet cable. This allows for the cellular router to be positioned for the best possible signal. Meanwhile, the SIM cards can be conveniently located in other locations such as the office, passenger area, or the bridge of a ship. The SIM Injector allows for easily swapping SIM cards without needing to access a cellular router.

IMPORTANT: Cellular WAN will not fallback to the local SIM if it is configured to use the SIM Injector.

Configuring the SIM Injector

1. Connect the SIM Injector to the LAN port of the cellular router.
2. Insert SIM cards into the SIM Injector. The SIM cards will be automatically detected.

IMPORTANT: SIM cards inserted into SIM Injector must not have a PIN code.

Note 1: The SIM Injector gets its IP address via DHCP and doesn't have a static IP address. To find it's address, please check the DHCP lease on the cellular router.

Configuring the Cellular Router

Step 1. Enable the SIM Injector communication protocol.

- 1a. If you are using a Balance cellular router, go to the **Network** tab (top navigation bar).
- 1b. If you are using a MAX cellular router, go to the **Advanced** tab (top navigation bar).
2. Under **Misc. settings** (left navigation bar) find **Remote SIM Management**.
3. In **Remote SIM Management**, click on the edit icon next to **Remote SIM is Disabled**.



4. Check the **Auto LAN discovery** checkbox and click **Save** and **Apply Changes**.

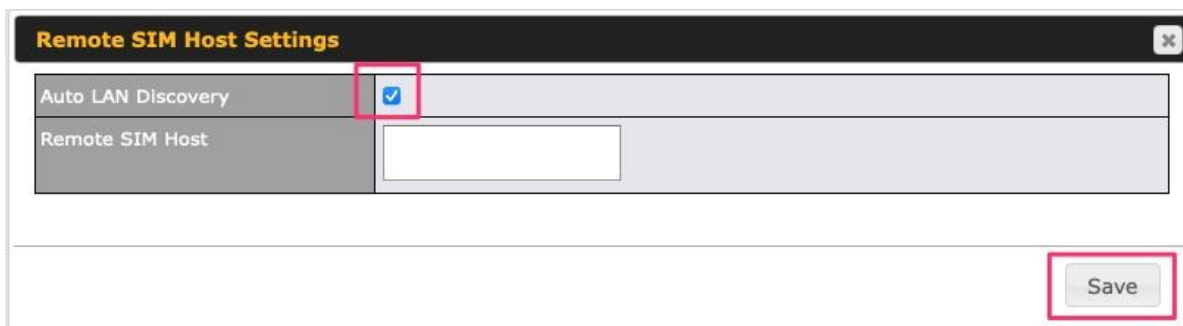

5. Click **Save** and then **Apply Changes**.

Step 2. Enable RemoteSIM for the selected Cellular interface.

1. Go to **Network** (top navigation bar), then **WAN** (left navigation bar) and click **Details** for a selected cellular WAN. This will open the WAN Connection Settings page.



2. Scroll down to **Cellular settings**.
3. In the **SIM Card** section, select **Use Remote SIM Only**.

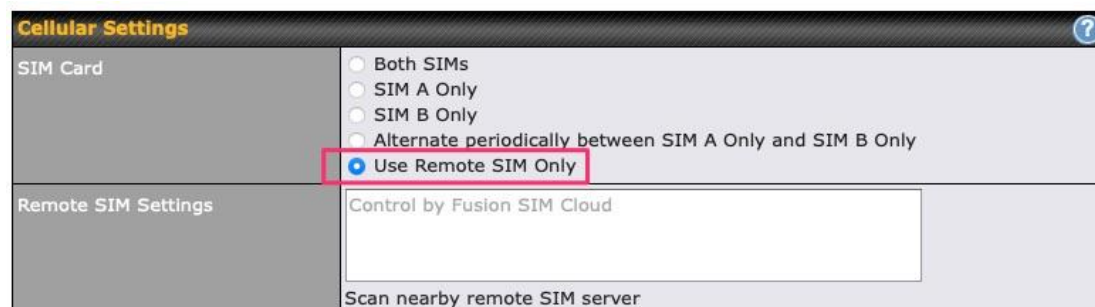

4. Enter configuration settings in **Remote SIM Settings** section. Click on **Scan nearby remote SIM server** to show the serial number(s) of the connected SIM Injector(s). Available configuration options for cellular interface are shown below:

A. Defining SIM Injector(s)

- Format: <S/N>
- Example 1: 1111-2222-3333
- Example 2: 1111-2222-3333 4444-5555-6666

B. Defining SIM Injector(s) SIM slot(s):

- Format: <S/N:slot number>
- Example 1: 1111-2222-3333:7,5 (the Cellular Interface will use SIM in slot 7, then 5)
- Example 2: 1111-2222-3333:1,2 1111-2222-3333:3,4 (the cellular Interface will use SIM in slot 1, then in 2 from the first SIM Injector, and then it will use 3 and 4 from the second SIM Injector).

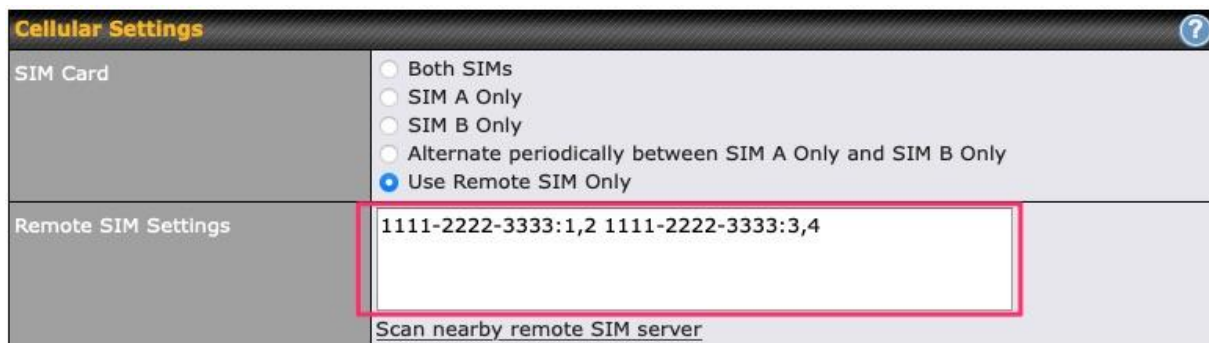

Note: It is recommended to use different SIM slots for each cellular interface.

5. Click **Save** and **Apply Changes**.

Step 3. (Optional) Custom SIM cards settings.

- 1a. For a Balance router, go to the **Network** (Top tab).
- 1b. For a MAX router, go to the **Advanced** (Top tab).
2. Under **Misc. settings** (Left-side tab) find **Remote SIM Management**.
3. Click on the **Add Remote SIM** button, fill in all the required info and click **Save**. This section allows defining custom requirements for a SIM card located in a certain SIM slot:
 - Enable/Disable roaming (by default roaming is disabled).
 - Add Custom mobile operator settings (APN, user name, password).
4. Repeat configuration for all SIM cards which need custom settings.
5. Click **Apply Changes** to take effect.

Scenario 2: SIM Injector in WAN of main Router and multiple Cellular Routers

Setup topology

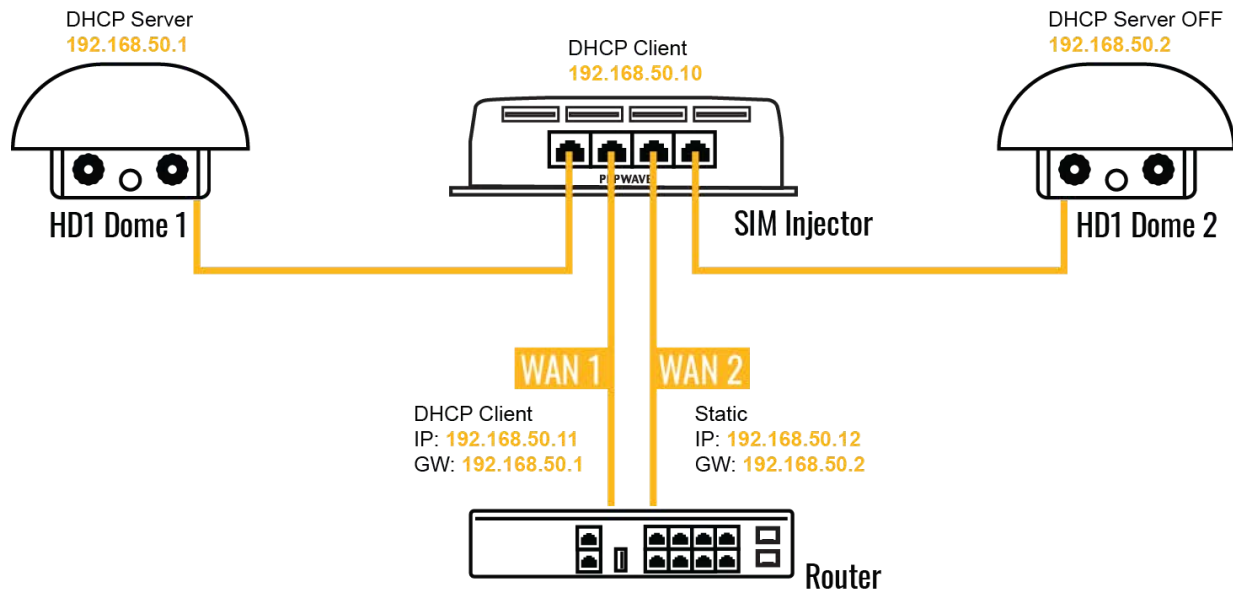

In this scenario, each HD Dome creates a WAN connection to the main router. A single SIM Injector is used to provide SIM cards for each HD Dome. The HD Dome can be replaced with any Peplink cellular router supporting RemoteSIM technology.

This scenario requires the completion of the configuration steps shown in Scenario 1 in addition to the configuration steps explained below.

Additional configurations for Cellular Routers

Step 1. Disable the DHCP server.

- HD Dome 1 should act as a DHCP server.
- HD Dome 2 should be configured to have a static IP address with DHCP disabled.
- Both routers should be in the same subnet (e.g. 192.168.50.1 and 192.168.50.2).

1. Go to **Network** (Top tab), then **Network Settings** (Left-side tab), and click on **Untagged LAN**. This will open up the LAN settings page.
2. Change the IP address to 192.168.50.2.
3. In the **DHCP Server** section, uncheck the checkbox to disable DHCP Server.
4. Click **Save** and **Apply Changes**.

Step 2. Ethernet port configuration

The Ethernet port must be set to **ACCESS** mode for each HD Dome. To do this, dummy VLANs need to be created first.

1. Go to **Network** (Top tab), then **Network Settings** (Left-side tab), and click on **New LAN**. This will open the settings page to create a dummy VLAN.
2. The image below shows the values that need to be changed to create a new VLAN:

LAN

IP Settings

IP Address: 192.168.10.1 (255.255.255.0 (/24))

Network Settings

Name: VLAN10

VLAN ID: 10

Inter-VLAN routing:

Captive Portal:

DHCP Server

DHCP Server: Enable

DHCP Server Logging:

IP Range: - (255.255.255.0 (/24))

Note: set different IP addresses for each HD dome (e.g. 192.168.10.1 and 192.168.10.2).

3. Click Save and **Apply Changes**.
4. Go to **Network** (Top tab), then **Port Settings** (Left-side tab).
5. Set the Port Type to **Access** and set VLAN to **Untagged LAN** (see picture below).

peplink | Dashboard | SpeedFusion Cloud | **Network** | AP | System | Status | Apply Changes

WAN

LAN

- Network Settings
- Port Settings**
- VPN

Port Settings

Name	Enable	Speed	Advertise Speed	Port Type	VLAN
1 LAN Port 1	<input checked="" type="checkbox"/>			Access	Untagged

6. Click **Save** and **Apply Changes**.

Configuration requirements for the main Router

Requirements for the main router are:

- Configure **WAN 1** as a DHCP client.
- **WAN 1** will automatically get the Gateway IP address from HD Dome 1.
- Configure **WAN 2** as a Static IP and set it to 192.168.50.12.
- Configure **WAN 2** Gateway to 192.168.50.2. Same as the HD Dome 2's IP address.

Scenario 3: SIM Injector in LAN of main Router and multiple Cellular Routers

Setup topology

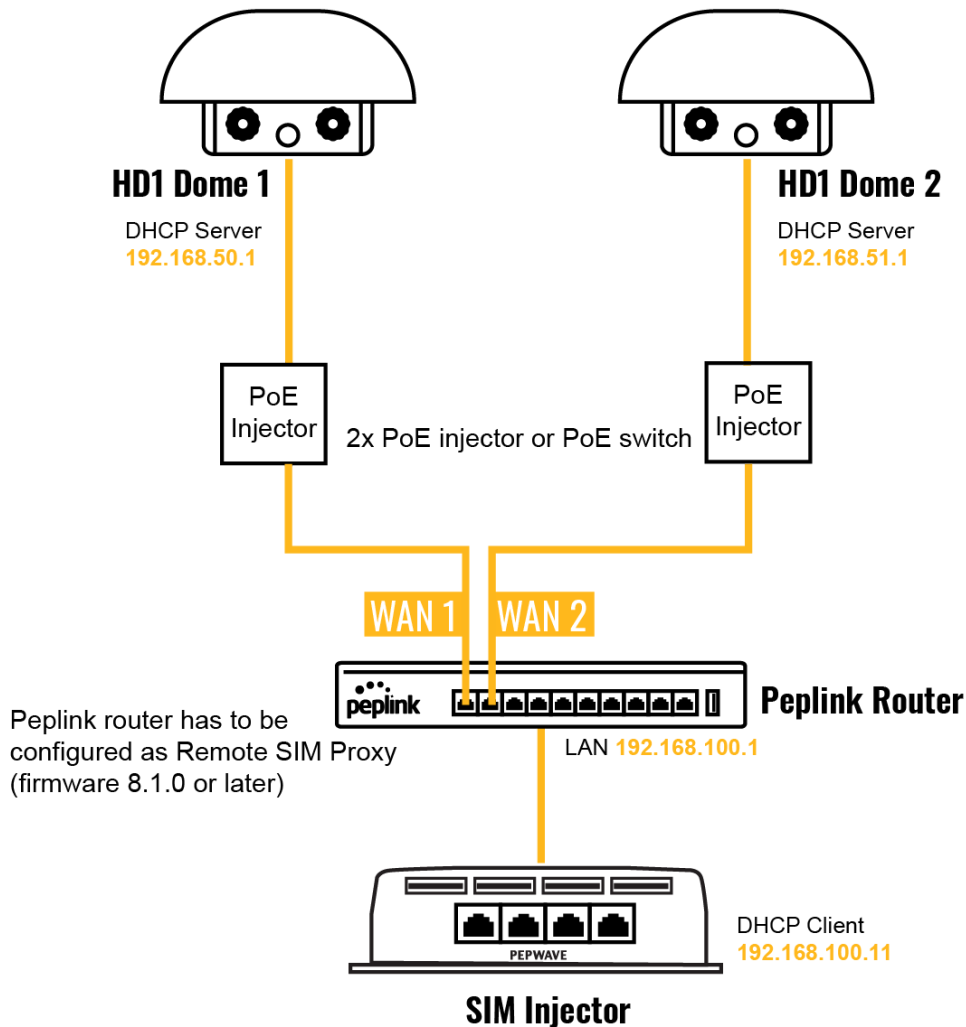

In this scenario, SIMs are provided to the HD Domes via the main router. In this example, the **Remote SIM Proxy** functionality needs to be enabled on the main router.

Notes:

- HD Dome can be replaced with any other cellular router that supports RemoteSIM.

- It is recommended to use Peplink [Balance series](#) or [X series](#) routers as the main router.

This scenario requires the completion of the configuration steps for the cellular router and the SIM Injector as in Scenario 1. The configuration for the main router is explained below.

Main Router configuration

IMPORTANT: Main router LAN side and Cellular Routers must be configured using different subnets, e.g. 192.168.**50**.1/24 and 192.168.**100**.1/24.

Note: please make sure the Peplink router is running Firmware 8.1.0 or above.

1. Open the main router WEB interface and change:
From <IP address>/cgi-bin/MANGA/**index.cgi** to <IP address>/cgi-bin/MANGA/**support.cgi**.

This will open the support.cgi page.

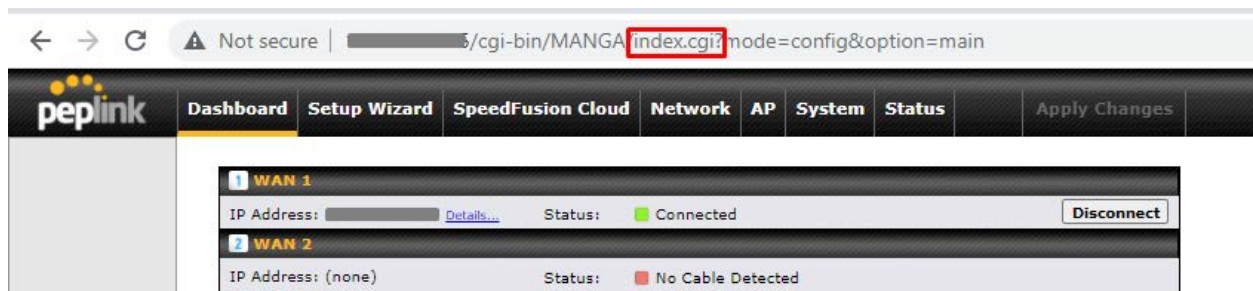

2. Scroll down to find **Remote SIM Proxy** and click on **[click to configure]** that is located next to it.
3. Check the **Enable** checkbox.
4. Click on **Save**.
5. Go back to the index.cgi page and click on **Apply Changes**.

Scenario 4: SIM Injector in a remote location

Setup topology

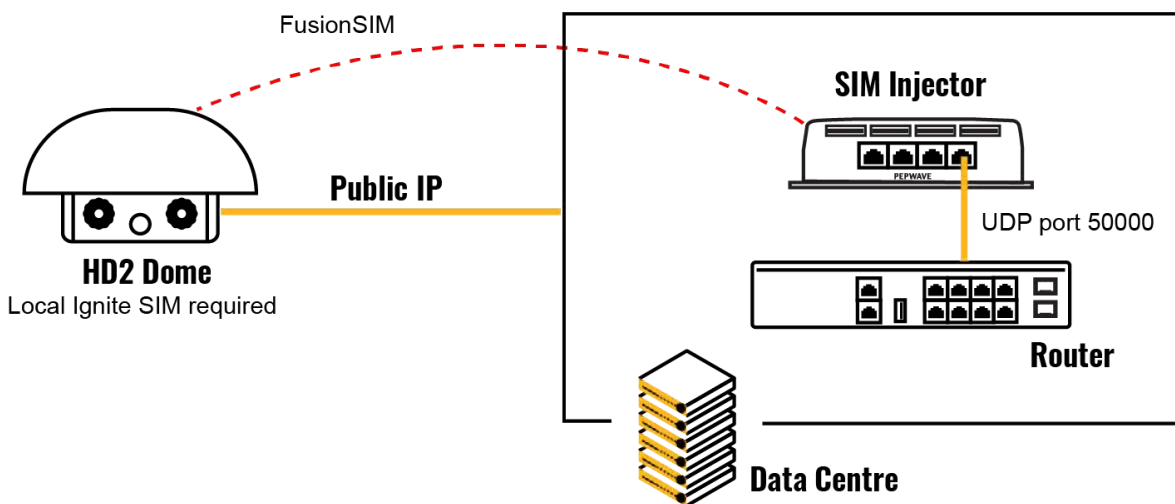

Requirements for installing a SIM Injector in a remote location:

- Cellular router communicates with the SIM Injector via UDP port 50000. Therefore this port must be reachable via public IP over the Internet.
- The one way latency between the cellular router and the SIM Injector should be **up to 250 ms**. A higher latency may lead to stability issues.
- The cellular router must have Internet connection to connect to the SIM Injector. It can be another Internet connection via Ethernet or Fiber if possible, or a secondary cellular interface with a local SIM (Ignite SIM).
- Due to its high latency, it is not recommended to use satellite WAN for connecting to a SIM Injector in remote locations.

SIM Injector configuration is the same as in Scenario 1.

Cellular Router configuration

Step 1. Enable the SIM Injector communication protocol.

- 1a. For a Balance cellular router, go to the **Network** (Top tab).
- 1b. For a MAX cellular router, go to the **Advanced** (Top tab).
2. Under **Misc. settings** (Left-side tab), find **Remote SIM Management**.
3. In **Remote SIM Management**, click on the edit icon next to **Remote SIM is Disabled**.
4. Enter the public IP of the SIM Injector and click **Save** and **Apply Changes**.

Remote SIM Host Settings	
Auto LAN Discovery	<input type="checkbox"/>
Remote SIM Host	84.199.92.62

Notes:

- Do NOT check **Auto LAN Discovery**.
- Adding a SIM Injector serial number to the **Remote SIM Host** field is a mistake!

Step 2. RemoteSIM and custom SIM card settings configurations are the same as in Scenario 1.

How to check if a Pepwave Cellular Router supports Remote SIM

1. Go to **Network** (Top tab), then **WAN** (Left-side tab), and click **Details** on any cellular WAN. This will open the WAN Connection Settings page.
2. Scroll down to **Cellular settings**.

If you can see the **Remote SIM Settings** section, then the cellular router supports RemoteSIM.

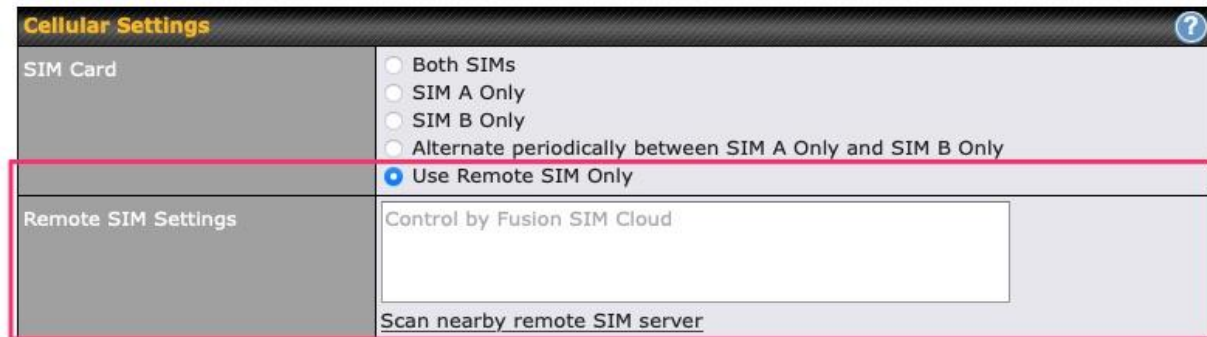

Monitor the status of the Remote SIM

1. Go to **Network** (Top tab), then **WAN** (Left-side tab), and click **Details** on the cellular WAN which was configured to use RemoteSIM.
2. Check the **WAN Connection Status** section. Within the cell WAN details, there is a section for **Remote SIM** (SIM card IMSI, SIM Injector serial number and SIM slot).

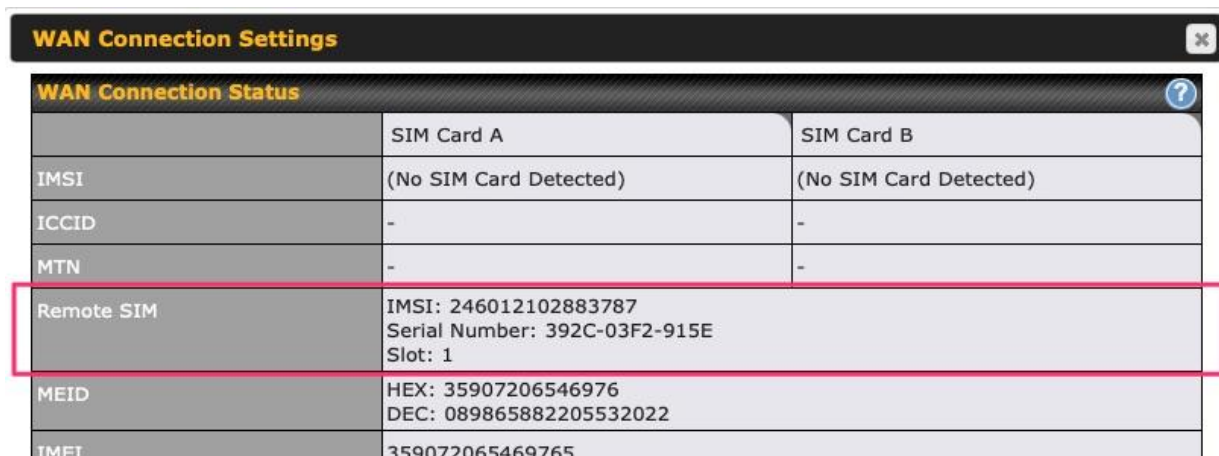

Appendix D. Case studies

MPLS Alternative

Our SpeedFusion enabled routers can be used to bond multiple low-cost/commodity Internet connections to replace an expensive managed business Internet connection, private leased line, MPLS, and frame relay without sacrificing reliability and availability.

Below are typical deployments for using our Balance routers to replace expensive MPLS connections with commodity connections, such as ADSL, 3G, and 4G LTE links.

Special features of Balance 580: have high availability capability

Special features of Balance 2500: have high availability capability and capable of connecting to optical fiber based LAN through SFP+ connector

Our WAN-bonding routers which comprise our Balance series and MediaFast series are capable of connecting multiple devices, and end users' networks to the Internet through multiple Internet connections.

Our MediaFast series routers have been helping students at many education institutions to enjoy uninterrupted learning

Option 1: MPLS Supplement

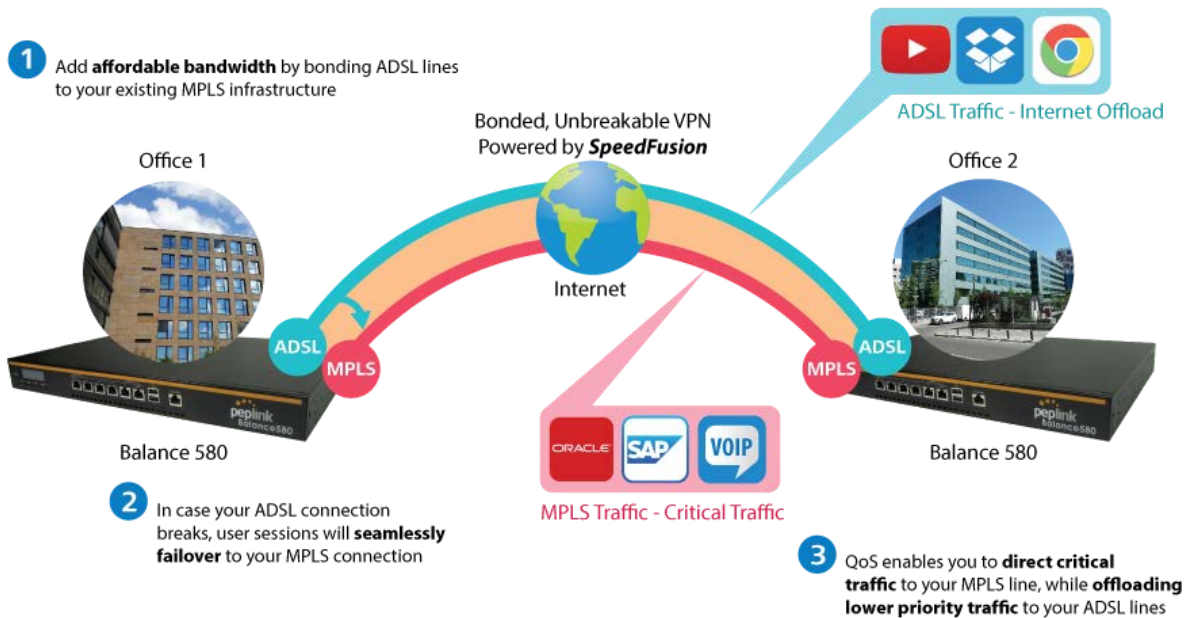

Affordably increase your bandwidth by adding commodity ADSL links to your MPLS connection. SpeedFusion technology bonds all your connections together, enabling session-persistent, user-transparent hot failover. QoS support, bandwidth control, and traffic prioritization gives you total control over your network.

Option 2: MPLS Alternative

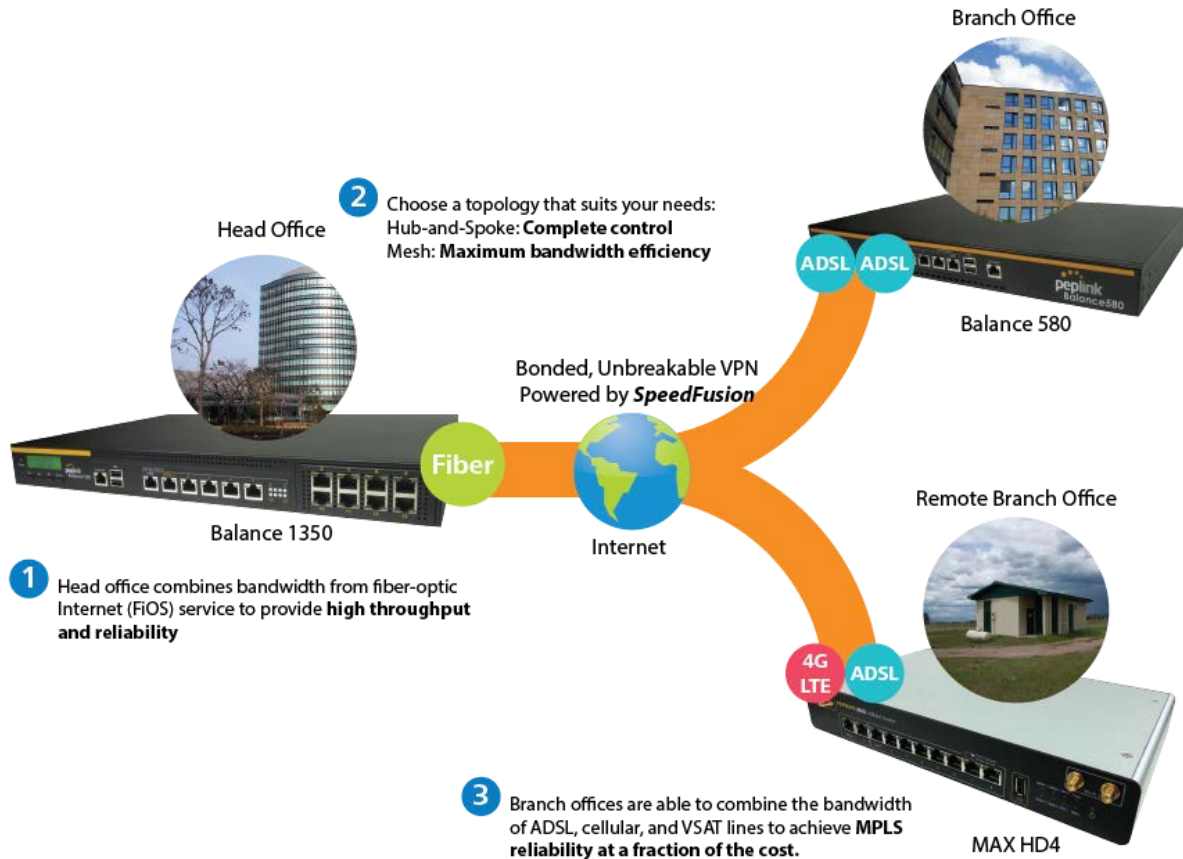

Achieve faster speeds and greater reliability while paying only 20% of MPLS costs by connecting multiple ADSL, 3G, and 4G LTE links. Choose a topology that suits your requirements: a hub-and-spoke topology maximizes control over your network, while a meshed topology can reduce your bandwidth overhead by enabling your devices to form Unbreakable VPN connections directly with each other.

Here is an example of to supplement of existing Multi-Office MPLS network with DSL bonding through SpeedFusion using a Balance 580 at the headquarters and Balance 210/310 at branch offices.

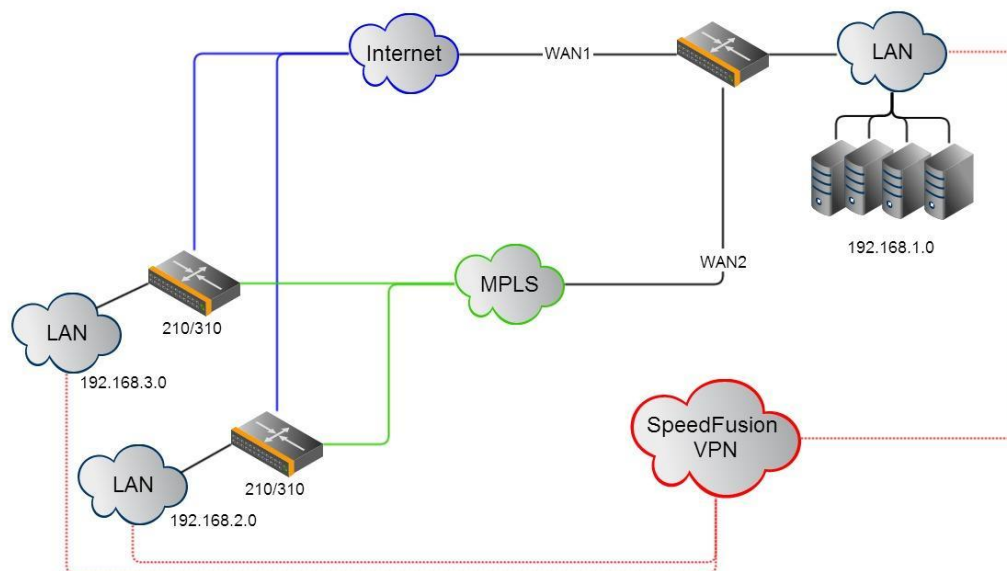

Environment:

- This organization has one head office with two branch offices, with most of the crucial information stored in a server room at the head office.
- They are connecting the offices together using a managed MPLS Solution. However, the MPLS Network is operating at capacity and upgrading the links is cost prohibitive.
- As the organization grows, it needs a cost-efficient way to add more bandwidth to its wide area network.
- Internet access at the remote sites is sent via a web proxy at head office for corporate web filtering compliance.

Requirement:

- User sessions need to remain uninterrupted
- More bandwidth is required at the head office location for direct internet access.

Recommended Solution:

- Form a SpeedFusion tunnel between the branch offices and head office to bond the MPLS and additional DSL lines.
- SpeedFusion allows for hot failover, maintaining a persistent session while switching connections.
- The DSLs at head office can be used for direct internet access providing lots of cheap internet bandwidth.
- Head office can use outbound policies to send internet traffic out over the DSLs and only use the MPLS connection for speedfusion, freeing up bandwidth.

Devices Deployed: Balance 210, Balance 310, Balance 580

Harrington Industrial Plastics



Overview

Harrington Plastics, the US's largest industrial plastics distributor, was looking to upgrade its network equipment. Harrington's team came across Peplink and started thinking about MPLS alternatives. By choosing Peplink, they saved a fortune on upgrades and ended up with yearly savings of up to \$100,000.

Requirements

- Zero network outages
- Flexible resilience options
- Cost-effective solution

Solution

- Peplink Balance 1350
- Peplink Balance 380
- Unbreakable VPN

Benefits

- Extreme savings of \$100,000 per year

- 4x the bandwidth
- Seamless hardware failover
- Highly available network due to WAN diversity
- Highly cost-effective compared to competing solutions
- Easy resilience achieved by adding 4G USB modems

Time For An Upgrade

Harrington Industrial Plastics decided it was time to upgrade its network equipment. Its existing solution used redundant MPLS for site-to-site traffic and broadband connections for Internet access. Harrington is the US's largest distributor of industrial plastics piping, serving all industries with corrosive and high-purity applications. It requires peak performance at all times in order to serve its large customer base and 43 busy branches.

Quick Deployment and Unbreakable Connectivity

In evaluating an upgrade to its network infrastructure, it was only natural that Harrington settled on the best in the industry — Peplink. Peplink partner Frontier Computer Corporation was chosen to help design and deploy the solution. Since Peplink gear is so easy to configure and install, Harrington was able to design, prototype and roll out the entire solution to the corporate headquarters and all 43 branches within just one year.

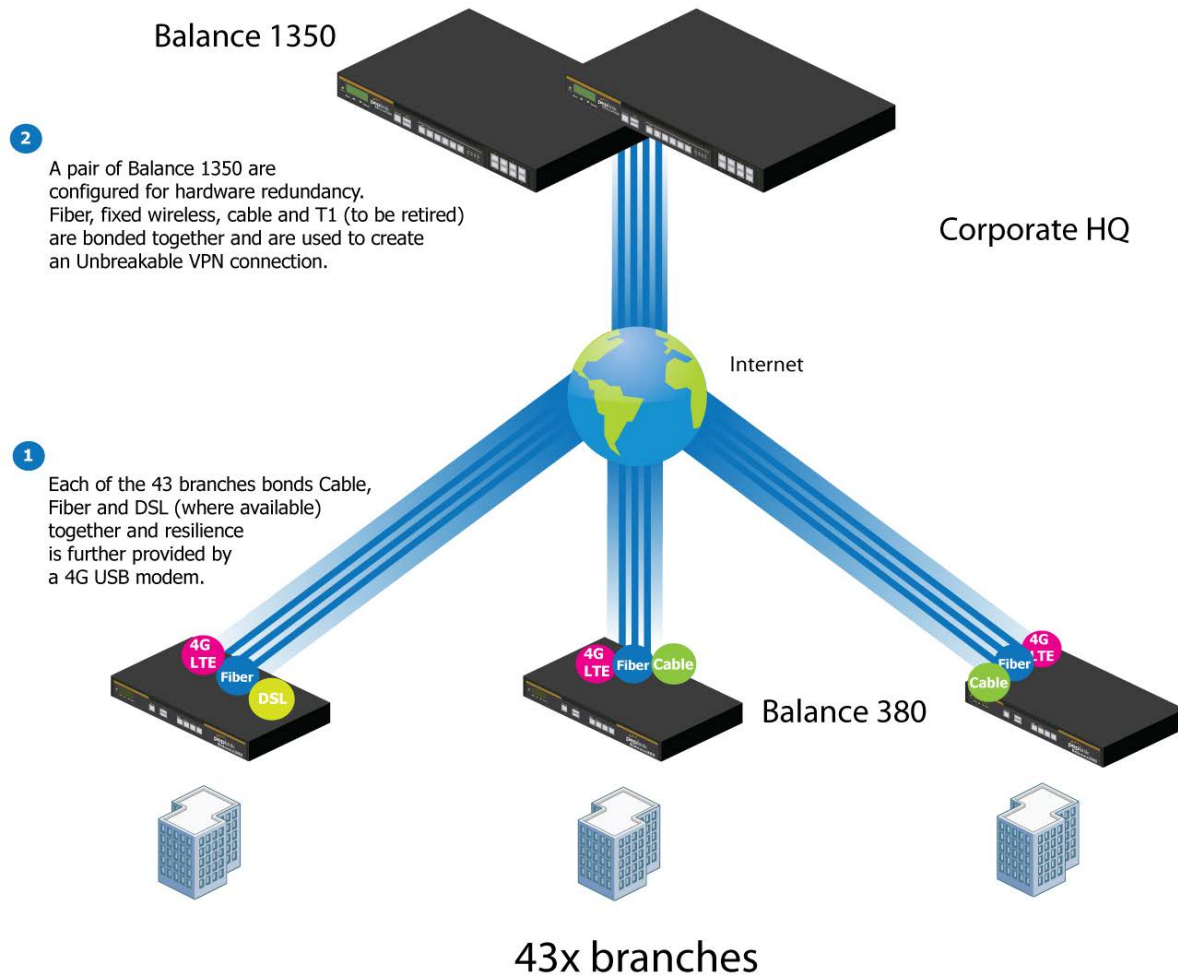

The corporate office houses a pair of redundant Balance 1350s for hardware resilience. Served by 4 separate links from multiple service providers, the network's chance of an outage is practically zero. All 43 branches are now equipped with a fleet of Balance 380s, bonding a combination of DSL, cable and fiber-optic links together with an additional 4G USB modem for added resilience. These work together to create an Unbreakable VPN connection to the Balance 1350s at the corporate office, connecting the final dot.

Dependable, Resilient Networking that's also Very Budget-friendly

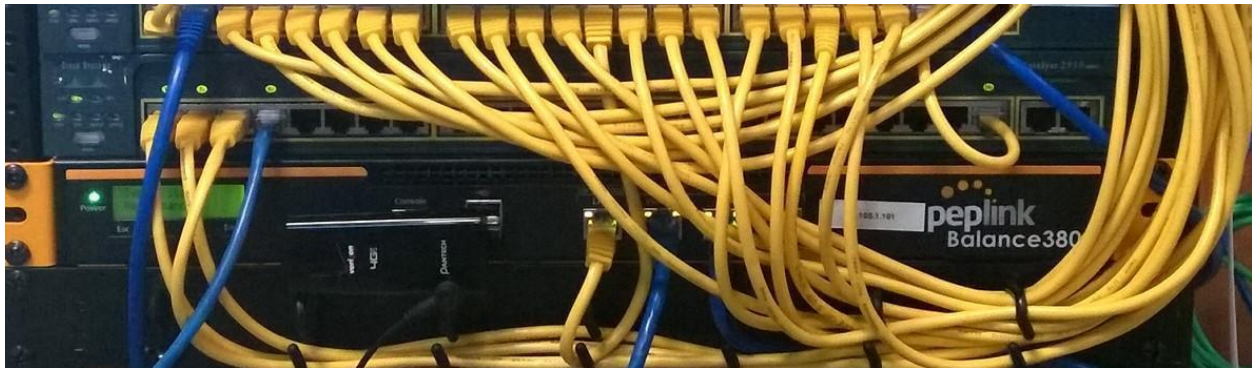

Harrington Industrial Plastics couldn't be happier. They now benefit from an extremely reliable and cost-effective network. Supplying additional resilience is as easy as plugging in a 4G USB modem. Where the MPLS 768kb deployed previously had cost them \$192000 a year for all 40 sites, their new solution is now only costing them \$92000. Their total bandwidth has been bumped from 36 Mbps to 138 Mbps.

PLUSS

Peplink + Citrix + VoIP Adds Up to Fast, Cost-Effective WAN for Pluss

Adding to Life
pluss

400
USERS

VoIP 290
EndPoints

30+
SITES

"It saves us money, is easy to manage and grows with us effortlessly."

Steve Taylor - Pluss

A Peplink customer since 2006, Pluss is a social enterprise that each year makes gainful employment a reality for more than 5000 disabled and disadvantaged UK citizens. With 37 locations and 300+ active users, Pluss makes heavy use of its WAN infrastructure, which until recently was built on managed MPLS lines.

Hoping to cut expenses and, if possible, boost performance at the same time, Steve Taylor, IT Manager at Pluss, set out to find a solution that would allow Pluss to replace costly MPLS service with a commodity alternative, such as DSL or EFM.

Steve found the solution Pluss needed in Peplink products, especially the Balance series of

high-performance enterprise routers and SpeedFusion bonding technology. Peplink now powers its entire WAN infrastructure with simple-to-install, highly reliable, and cost-effective Peplink gear, which allows it to aggregate DSL and other commodity connections and replace expensive leased lines.

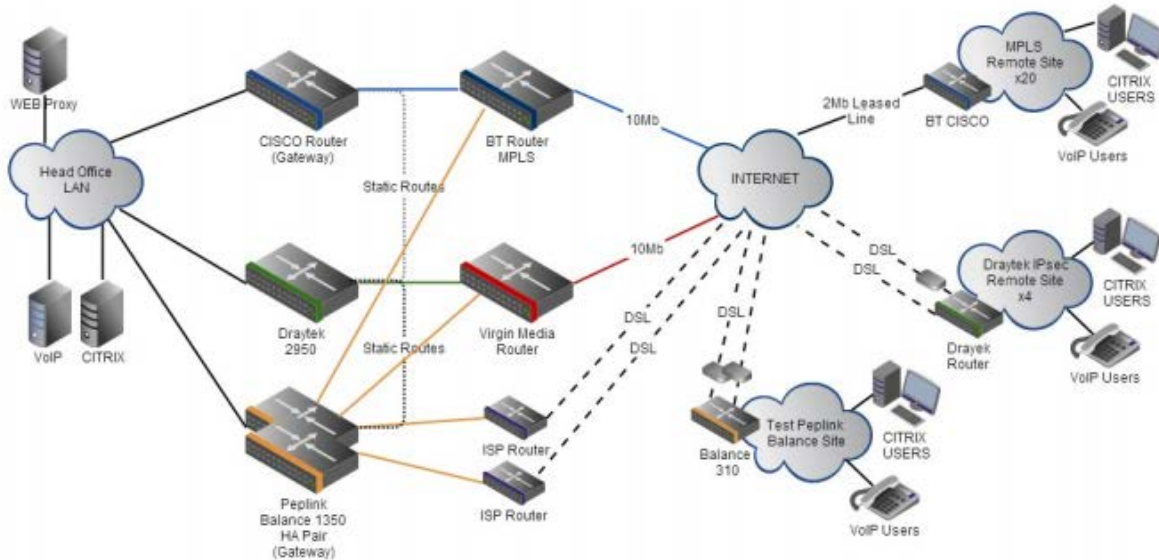

Colégio Next - Enabling eLearning



Colégio Next, a recognized Apple Distinguished School - deploys over 500 iPads to its 600 students as a teaching and learning tool.

Despite being equipped with iPads, teachers and students alike were not making use of them. The reason for this was because of the slow network access speeds. Apps would not download

and course contents were inaccessible. Often, having more than a couple students connected to the same Wi-Fi access point was enough to bring it to its knees.

Colégio Next needed a unique solution, so they contacted Peplink.

Requirements

- Solve network congestion problem caused by 600 students over rural Internet connections
- Wi-Fi that can handle 50+ users per classroom
- An affordable network infrastructure that can provide simultaneous access to media-rich educational content

Solution

- Peplink MediaFast
- Multi-WAN Content-caching router, tailor-made for Education networking.
- AP One 300M
- Enterprise grade AP, 5GHz Wi-Fi, up to 60 concurrent users.

Benefits

- Instant, simultaneous access to media-rich educational content for 500+ iPads
- Wi-Fi connection stability for 50+ users per classroom, not achievable by other tested equipment
- Teachers, students and guests can be assigned access priority to available bandwidth, further preventing congestion
- iOS updates (often 2GB size) no longer congest the network as they are downloaded only once, cached on the MediaFast and then distributed to all iOS devices
- AP Controller makes MAC Address Filtering easy. Students are assigned to designated APs by their devices' MAC Address in order to prevent saturating any single AP.
- Flawless iPad AirPlay mirroring at all times
- iPads are used all day, reaching their full potential with a fast and stable network all the time
- Students are far more engaged and teachers rely on their iPads all day

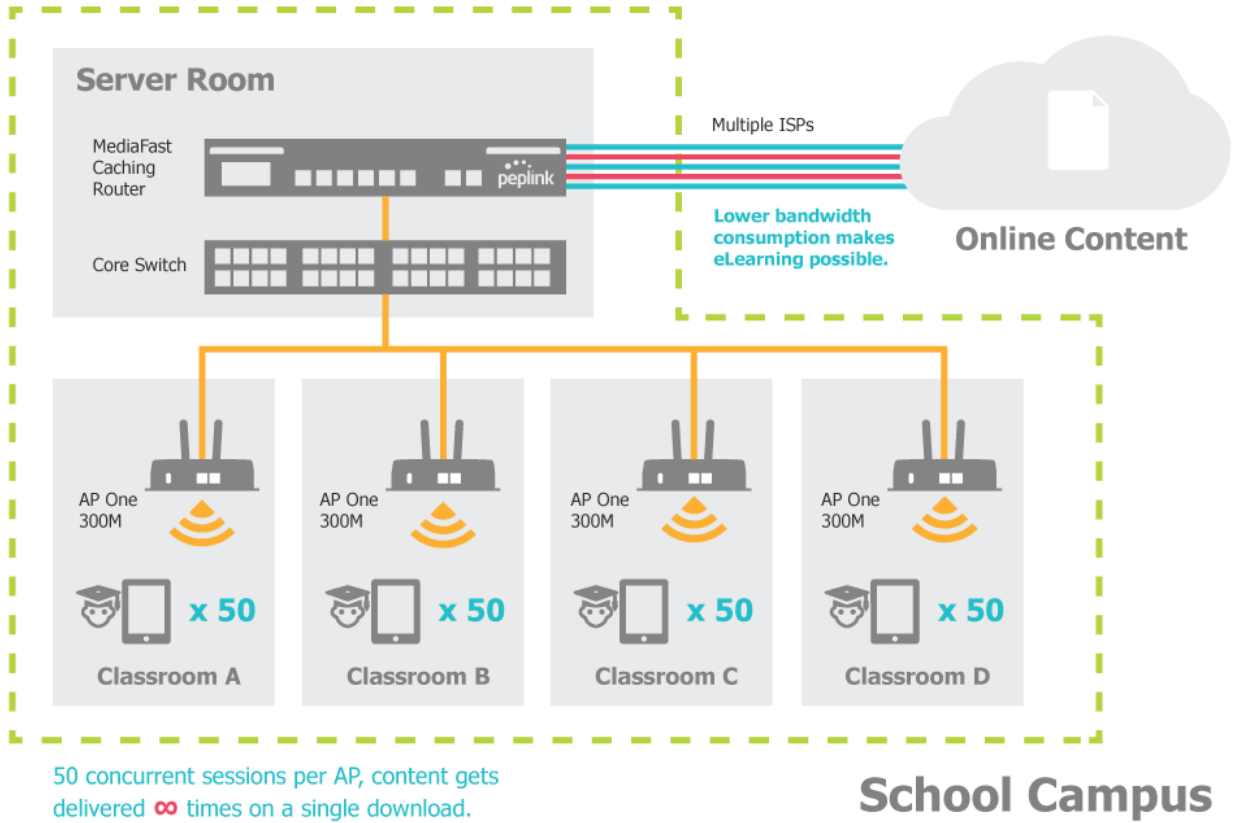

50 concurrent sessions per AP, content gets delivered ∞ times on a single download.

School Campus

Performance Optimization

Scenario

In this scenario, email and web browsing are the two main Internet services used by LAN users. The mail server is external to the network. The connections are ADSL (WAN1, with slow uplink and fast downlink) and Metro Ethernet (WAN2, symmetric).

Solution

For optimal performance with this configuration, individually set the WAN load balance according to the characteristics of each service.

- Web browsing mainly downloads data; sending emails mainly consumes upload bandwidth.
- Both connections offer good download speeds; WAN2 offers good upload speeds.
- Define WAN1 and WAN2's inbound and outbound bandwidths to be 30M/2M and 50M/50M, respectively. This will ensure that outbound traffic is more likely to be routed through WAN2.
- For HTTP, set the weight to 3:4.
- For SMTP, set the weight to 1:8, such that users will have a greater chance to be routed via WAN2 when sending email.

Maintaining the Same IP Address Throughout a Session

Scenario

Some IP address-sensitive websites (for example, Internet banking) use both client IP address and cookie matching for session identification. Since load balancing uses different IP addresses, the session is dropped when a mismatched IP is detected, resulting in frequent interruptions while visiting such sites.

Solution

Make use of the persistence functionality of the Peplink Balance. With persistence configured and the **By Destination** option selected, the Peplink Balance will use a consistent WAN connection for source-destination pairs of IP addresses, preventing sessions from being dropped.

With persistence configured and the option **By Source** is selected, the Peplink Balance uses a consistent WAN connection for same-source IP addresses. This option offers higher application compatibility but may inhibit the load balancing function unless there are many clients using the Internet.

Settings

Set persistence in at **Advanced>Outbound Policy**.

Click **Add Rule**, select **HTTP** (TCP port 80) for web service, and select **Persistence**. Click **Save** and then **Apply Changes**, located at the top right corner, to complete the process.

Add a New Custom Rule
✕

Service Name *	HTTP Persistence
Enable	<input checked="" type="checkbox"/>
Source	Any
Destination	Any
Protocol	TCP ← HTTP
Port *	Single Port Port: 80
Algorithm	Persistence
Persistence Mode	<input type="radio"/> By Source <input checked="" type="radio"/> By Destination
Load Distribution	<input checked="" type="radio"/> Auto <input type="radio"/> Custom
Terminate Sessions on Link Recovery	<input type="checkbox"/> Enable

Tip

A network administrator can use the traceroute utility to manually analyze the connection path of a particular WAN connection.

Bypassing the Firewall to Access Hosts on LAN

Scenario

There are times when remote access to computers on the LAN is desirable; for example, when hosting web sites, online businesses, FTP download and upload areas, etc. In such cases, it may be appropriate to create an inbound NAT mapping for the network to allow some hosts on the LAN to be accessible from outside of the firewall.

Solution

The web admin interface can be used to add an inbound NAT mapping to a host and to bind the host to the WAN connection(s) of your choice. To begin, navigate to **Network>NAT Mappings**.

In this example, the host with an IP address of 192.168.1.102 is bound to 10.90.0.75 of WAN1:

LAN Client(s) ?	IP Address ▾
Address ?	192.168.1.102
Inbound Mappings ?	Connection / Inbound IP Address(es)
	<input checked="" type="checkbox"/> WAN 1 <input checked="" type="checkbox"/> 10.90.0.75 (Interface IP)
	<input type="checkbox"/> WAN 2
	<input type="checkbox"/> WAN 3
	<input type="checkbox"/> WAN 4
	<input type="checkbox"/> WAN 5
	<input type="checkbox"/> WAN 6
	<input type="checkbox"/> WAN 7
<input type="checkbox"/> Mobile Internet	
Outbound Mappings ?	Connection / Outbound IP Address
	WAN 1 10.90.0.75 (Interface IP) ▾
	WAN 2 10.90.0.76 (Interface IP) ▾
	WAN 3 Interface IP ▾
	WAN 4 Interface IP ▾
	WAN 5 Interface IP ▾
	WAN 6 Interface IP ▾
	WAN 7 Interface IP ▾
	Mobile Internet Interface IP ▾

Click **Save** and then **Apply Changes**, located at the top right corner, to complete the process.

Inbound Access Restriction

Scenario

A firewall is required in order to protect the network from potential hacker attacks and other Internet security threats.

Solution

Firewall functionality is built into the Peplink Balance. By default, inbound access is unrestricted. Enabling a basic level of protection involves setting up firewall rules.

For example, in order to protect your private network from external access, you can set up a firewall rule between the Internet and your private network. To do so, navigate to **Network>Firewall>Access Rules**. Then click the **Add Rule** button in the **Inbound Firewall Rules** table and change the settings according to the following screenshot:

Add a New Inbound Firewall Rule
✕

New Firewall Rule

Rule Name	Inbound Firewall Rule Exce
Enable	<input checked="" type="checkbox"/>
WAN Connection	Any ▾
Protocol	TCP ▾ ← HTTP ▾
Source	Any Address ▾ Any Port ▾
Destination	Any Address ▾ Single Port ▾ Port: 80
Action	<input checked="" type="radio"/> Allow <input type="radio"/> Deny
Event Logging	<input type="checkbox"/> Enable

After the fields have been entered as in the screenshot, click **Save** to add the rule. Afterwards, change the default inbound rule to **Deny** by clicking the **default** rule in the **Inbound Firewall Rules** table. Click **Apply Changes** on the top right corner to complete the process.

Outbound Access Restriction

Scenario

For security reasons, it may be appropriate to restrict outbound access. For example, you may want to prevent LAN users from using ftp to transfer files to and from the Internet. This can easily be achieved by setting up an outbound firewall rule with the Peplink Balance.

Solution

To setup a firewall between the Internet and private network for outbound access, navigate to **Network>Firewall>Access Rules**. Click the **Add Rule** button in the **Outbound Firewall Rules** table, and then adjust settings according the screenshot:

Add a New Outbound Firewall Rule ✕

New Firewall Rule

Rule Name	<input type="text" value="No FTP access"/>
Enable	<input checked="" type="checkbox"/>
Protocol	TCP <input type="text" value="← FTP"/>
Source	Any Address <input type="text" value="Any Port"/>
Destination	Any Address <input style="display: inline-block; width: 50px;" type="text" value="Single Port"/> Port: <input type="text" value="21"/>
Action	<input type="radio"/> Allow <input checked="" type="radio"/> Deny
Event Logging	<input checked="" type="checkbox"/> Enable

After the fields have been entered as in the screenshot, click **Save** to add the rule. Click **Apply Changes** on the top right corner to complete the process.

Appendix E. Overview of ports used by Peplink SD-WAN routers and other Peplink services

Default Number	Port	Usage	Service	Inbound/Outbound	Default Status
UDP 5246		Data flow	InControl	Outbound	Enabled
TCP 443		HTTPS service	InControl	Outbound	Enabled
TCP 5246		Optional, used when TCP 443 is not responding	InControl	Outbound	Enabled
TCP 5246		Remote Web Admin	InControl Appliance Virtual	Outbound	Enabled
TCP 4500		VPN Data (TCP Mode)	PepVPN SpeedFusion	/ Inbound / Outbound*	/ Disabled
TCP 32015		VPN handshake	PepVPN SpeedFusion	/ Inbound / Outbound*	/ Disabled
UDP 4500		VPN Data	PepVPN SpeedFusion	/ Inbound / Outbound*	/ Disabled
UDP 32015 ^o		VPN Data (alternative)	PepVPN SpeedFusion	/ Inbound / Outbound*	/ Disabled
TCP/UDP 4500+N-1 [^]		VPN Sub-Tunnels Data	PepVPN SpeedFusion	/ Inbound / Outbound*	/ Disabled
UDP 32015+N-1 [^]		VPN Sub-Tunnels Data (alternative)	PepVPN SpeedFusion	/ Inbound / Outbound*	/ Disabled
UDP 4500		VPN Data	IPsec	Inbound / Outbound*	/ Disabled
UDP 500		VPN initiation	IPsec	Inbound / Outbound*	/ Disabled
UDP 500		L2TP	Remote User Access	Inbound	Disabled
UDP 1701		L2TP	Remote User Access	Inbound	Disabled
UDP 4500		L2TP	Remote User Access	Inbound	Disabled
UDP 1194		OpenVPN	Remote User Access	Inbound	Disabled
IP 47		PPTP (GRE)	Remote User Access	Inbound	Disabled
TCP 2222		Remote Assistance Direct connection	Peplink Troubleshooting Assistance	Outbound	Enabled
TCP 80		HTTP traffic	Web Admin Interface	Inbound	Enabled

		access		
TCP 443	HTTPS traffic	Web Admin Interface access (secure)	Inbound	Enabled
TCP 8822	SSH	SSH	Inbound	Disabled
UDP 161	SNMP Get	SNMP monitoring	Inbound	Disabled
UDP 162	SNMP Trap	SNMP monitoring	Outbound	Disabled
TCP, UDP 1812	Radius Authentication	Radius	Outbound	Disabled
TCP, UDP 1813	Radius Accounting	Radius	Outbound	Disabled
UDP 123	Network Time Protocol	NTP	Inbound Outbound	Disabled Enabled
TCP 60660	Real-time location data in NMEA format	GPS	Outbound	Disabled

Disclaimer:

- By default, only TCP 32015 and UDP 4500 are needed for PepVPN / SpeedFusion.
- Inbound / Outbound* - Inbound = For Server mode; Outbound = For Client mode
- UDP 32015° - If IPsec VPN or L2TP/IPsec RUA is enabled, the UDP 4500 is occupied, so PepVPN / SpeedFusion will automatically switch to UPD 32015 as VPN data port .
- UDP 32015+N-1^ / TCP/UDP 4500+N-1^ - When using Sub-Tunnels, multiple ports are in use (1 for each Sub-Tunnel profile).
- The default UDP data ports used when using (N number of Sub-Tunnel profiles) are: 4500...4500+N-1, or (when port 4500 is in use by IPsec or L2TP/IPsec) 32015... 32015+N-1".

Appendix F. Troubleshooting

Problem 1

Outbound load is only distributed over one WAN connection.

Solution

Outbound load balancing can only be distribute traffic evenly between available WAN connections if many outbound connections are made. If there is only one user on the LAN and only one download session is made from his/her browser, the WAN connections cannot be fully utilized.

For a single user, download management applications are recommended. The applications can split a file into pieces and download the pieces simultaneously. Examples include: DownThemAll (Firefox Extension), iGetter (Mac), etc.

If the outbound traffic is going across the SpeedFusion™ tunnel, (i.e., transferring a file to a VPN peer) the bandwidth of all WAN connections will be bonded. In this case, all bandwidth will be utilized and a file will be transferred across all available WAN connections.

For additional details, please refer to this FAQ:

<https://forum.peplink.com/t/speed-test-tool-for-combined-download-speed-in-multi-wan-environment/8457>

Problem 2

I am using a download manager program (e.g., Download Accelerator Plus, DownThemAll, etc.). Why is the download speed still only that of a single link?

Solution

First, check whether all WAN connections are up. Second, ensure your download manager application has split the file into 3 parts or more. It is also possible that all of 2 or even 3 download sessions were being distributed to the same link by chance.

Problem 3

I am using some websites to look up my public IP address, e.g., www.whatismyip.com. When I press the browser's Refresh button, the server almost always returns the same address. Isn't the IP address supposed to be changing for every refresh?

Solution

The web server has enabled the **Keep Alive** function, which ensures that you use the same TCP session to query the server. Try to test with a website that does not enable **Keep Alive**.

Problem 4

What can I do if I suspect a problem on my LAN connection?

Solution

You can test the LAN connection using ping. For example, if you are using DOS/Windows, at

the command prompt, type `ping 192.168.1.1`. This pings the Peplink Balance device (provided that Peplink Balance's IP is 192.168.1.1) to test whether the connection to the Peplink Balance is OK.

Problem 5

What can I do if I suspect a problem on my Internet/WAN connection?

Solution

You can test the WAN connection using ping, as in the solution to Problem 4. As we want to isolate the problems from the LAN, ping will be performed from the Peplink Balance. By using **Ping/Traceroute** under the **Status** tab of the Peplink Balance, you may be able to find the source of the problem.

Problem 6

When I upload files to a server via FTP, the transfer stalls after a few kilobytes of data are sent. What should I do?

Solution

The maximum transmission unit (MTU) or MSS setting may need to be adjusted. By default, the MTU is set at 1440. Choose **Auto** for all of your WAN connections. If that does not solve the problem, you can try the MTU 1492 if a connection is DSL. If the problem still persists, change the size to progressively smaller values until your problem is resolved (e.g., 1462, 1440, 1420, 1400, etc).

Additional troubleshooting resources:

Peplink Community Forums: <https://forum.peplink.com/>

Appendix G.

FCC Requirements for Operation in the United States

Federal Communications Commission (FCC) Compliance Notice:

For Balance 30 Pro

Federal Communication Commission Interference Statement

This equipment has been tested and found to comply with the limits for a Class A digital device, pursuant to part 15 of the FCC Rules. These limits are designed to provide reasonable protection against harmful interference when the equipment is operated in a commercial environment. This equipment generates, uses, and can radiate radio frequency energy and, if not installed and used in accordance with the instruction manual, may cause harmful interference to radio communications. Operation of this equipment in a residential area is likely to cause harmful interference in which case the user will be required to correct the interference at his own expense.

FCC Caution Any changes or modifications not expressly approved by the party responsible for compliance could void the user's authority to operate this equipment.

Radiation Exposure Statement :

This equipment complies with FCC radiation exposure limits set forth for an uncontrolled environment. This equipment should be installed and operated with a minimum distance of 49 cm between the radiator and your body.

Note The country code selection is for non-US models only and is not available to all US models. Per FCC regulation, all WiFi products marketed in US must fixed to US operation channels only.

Battery Caution Statement

Risk of explosion if the battery replaced by an incorrect type, place the battery into fire, a hot oven, extremely high temperature or low air pressure surrounding environment, the leakage of flammable liquid or gas, and mechanically crushing or cutting of the battery.

CE Statement for Pepwave Routers (Balance 30 Pro)

DECLARATION OF CONFORMITY

We affirm the electrical equipment manufactured by us fulfils the requirements of the Radio Equipment Directive 2014/53/EU.

Name of manufacturer	PISMO LABS TECHNOLOGY LIMITED
Contact information of the manufacturer	A8, 5/F, HK Spinners Industrial Building Phase 6, 481 Castle Peak Road Cheung Sha Wan Hong Kong tel. (852) 2990 7600, fax. (852) 3007 0588 e-mail: cs@peplink.com
Description of the appliance	PEPWAVE / PEPLINK Wireless Product
Model name of the appliance	Peplink Balance 30 Pro BPL-031-LTEA-W-T Balance 30 Pro Pismo 811AC B30 Pro
Trade name of the appliance	PEPWAVE / PEPLINK

The construction of the appliance is in accordance with the following standards:

EN 300 328 V2.1.1
EN 301 893 V2.1.1
EN 301908-1 V11.1.1
EN 301 489-1 V2.2.1
Draft EN 301 489-17 V3.2.0
Draft EN 301 489-52 V1.1.0
EN 55032: 2015 + AC:2016
EN 61000-3-2: 2014
EN 61000-3-3: 2013
EN 55024: 2010 + A1 :2015
EN 62311 : 2008
EN 62368-1:2014/AC:2015

Yours sincerely,



Antony Chong
Director of Hardware Engineering
Peplink International Limited



AT	BE	BG	HR	CY	CZ	DK	EE	FI	FR	DE	EL	HU	IE
IT	LV	LT	LU	MT	NL	PL	PT	RO	SK	SI	ES	SE	UK(NI)

2.4GHz (2412 - 2472 MHz) : 19.93 dBm

5GHz (5150 - 5250 MHz) : 22.88 dBm

WWAN : Refer 3GPP TS 36.521 -1 (UE Power class)

Table 4-6: Conducted Tx (Transmit) Power Tolerances

Parameter	Conducted transmit power	Notes
LTE		
LTE Band 1,3,8,20	+23 dBm \pm 1 dB	
LTE Band 7	+22 dBm \pm 1 dB	
UMTS		
Band 1 (IMT 2100 12.2 kbps) Band 3 (UMTS 1800 12.2 kbps) Band 8 (UMTS 900 12.2 kbps)	+23 dBm \pm 1 dB	Connectorized (Class 3)

This equipment complies with CE radiation exposure limits set forth for an uncontrolled environment. This equipment should be installed and operated with a minimum distance of 20cm between the radiator & your body.

Contact as: <https://www.peplink.com/>

FCC Requirements for Operation in the United States Federal Communications Commission (FCC) Compliance Notice:

For Balance One

Federal Communication Commission Interference Statement

This equipment has been tested and found to comply with the limits for a Class A digital device, pursuant to Part 15 of the FCC Rules. These limits are designed to provide reasonable protection against harmful interference when the equipment is operated in a commercial environment. This equipment generates, uses, and can radiate radio frequency energy, and if it is not installed and used in accordance with the instruction manual, it may cause harmful interference to radio communications. Operation of this equipment in a residential area is likely to cause harmful interference, in which case the user will be required to correct the interference at his own expense.

Any changes or modifications not expressly approved by the party responsible for compliance could void your authority to operate the equipment.

Radiation Exposure Statement

This equipment complies with FCC RF radiation exposure limits set forth for an uncontrolled environment. This equipment should be installed and operated with a minimum distance of 20 centimeters between the radiator and your body.

Industry Canada Statement (Balance One)

This product meets the applicable Innovation, Science and Economic Development Canada technical specifications.

Le présent produit est conforme aux spécifications techniques applicables d'Innovation, Sciences et Développement économique Canada.

This device contains licence-exempt transmitter(s)/receiver(s) that comply with Innovation, Science and Economic Development Canada's licence-exempt RSS(s). Operation is subject to the following two conditions:

- (1) This device may not cause interference.
- (2) This device must accept any interference, including interference that may cause undesired operation of the device.

Le présent appareil est conforme aux CNR d'Industrie Canada applicables aux appareils radio exempts de licence. L'exploitation est autorisée aux deux conditions suivantes:

- (1) l'appareil ne doit pas produire de brouillage, et
- (2) l'utilisateur de l'appareil doit accepter tout brouillage radioelectrique subi, meme si le brouillage est susceptible d'en

(i) The device for operation in the band 5150-5250 MHz is only for indoor use to reduce the potent for harmful interference to co-channel mobile satellite systems

(ii) For devices with detachable antenna(s), the maximum antenna gain permitted for devices in band 5725-5850 MHz shall be such that the equipment still complies with the e.i.r.p. limits specified for point-to-point and non-point-to-point operation as appropriate and

The high-power radars are allocated as primary users (i.e. priority users) of the band 5725-5850 MHz and that these radars could cause interference and/or damage to LE-LAN devices.

(i) Le dispositif fonctionnant dans la bande 5150-5250 MHz est reserve uniquement pour utilisation a l'interieur afin de reduire les risques de brouillage prejudiciable aux systemes de satellites mobiles utilisant les memes canaux

(ii) Le gain maximal d'antenne permis pour les dispositifs avec antenne(s) amovible(s) utilisant bande 5725-5850 MHz doit se conformer a la limitation P.I.R.E specifiee pour l'exploitation point a point et non point a point, selon le cas.

En outre, les utilisateurs devraient aussi etre avises que les utilisateurs de radars de haute puissance sont designes utilisateurs principaux (c.-a-d., qu'ils ont la priorite) pour les bande 5725-5850 MHz et que ces radars pourraient causer du brouillage et/ou des dommages aux dispositifs LAN-EL.

Radiation Exposure Statement

This device complies with the ISED radiation exposure limit set forth for an uncontrolled environment. This device should be installed and operated with minimum distance 20cm between the radiator & your body.

Cet equipement est conforme avec l'exposition aux radiations ISED definies pour un environnement non controle. Cet equipement doit etre installe et utilise a une distance minimum de 20 cm entre le radiateur et votre corps.

Battery Caution Statement (Balance One)

Risk of explosion if the battery replaced by an incorrect type, place the battery into fire, a hot oven, extremely high temperature or low air pressure surrounding environment, the leakage of flammable liquid or gas, and mechanically crushing or cutting of the battery.

CE Statement for Pepwave Routers (Balance One)

DECLARATION OF CONFORMITY

We affirm the electrical equipment manufactured by us fulfils the requirements of the Radio Equipment Directive 2014/53/EU.

Name of manufacturer	Pismo Labs Technology Limited
Contact information of the manufacturer	Unit A5, 5/F, HK Spinners Ind. Bldg., Phase 6, 481 Castle Peak Road, Cheung Sha Wan, Kowloon, Hong Kong tel. (852) 2990 7600, fax. (852) 3007 0588 e-mail: cs@peplink.com
Description of the appliance	Peplink / Pepwave / Pismo wireless product
Model name of the appliance	Balance One Balance One AC, Balance One Core
Trade name of the appliance	Pepwave / Peplink / Pismo

The construction of the appliance is in accordance with the following standards:

- EN 55032:2015
- EN 55024:2010+A1:2015
- EN 61000-3-2:2014
- EN 61000-3-3:2013
- EN 301 489-1 V2.1.1
- EN 301 489-3 V2.1.1
- EN 301 489-17 V3.1.1
- EN 300 328 V2.1.1
- EN 301 893 V2.1.1
- EN 300 440 V2.1.1
- EN 50385:2017
- EN 60950-1:2006+A11:2009+A1:2010+A12:2011+A2:2013

Yours sincerely,



Keith Chau
 General Manager
 Peplink International Limited



AT	BE	BG	HR	CY	CZ	DK	EE	FI	FR	DE	EL	HU	IE
IT	LV	LT	LU	MT	NL	PL	PT	RO	SK	SI	ES	SE	UK(NI)

2.4GHz (2412 - 2472 MHz) : 16.59 dBm

5GHz (5150 - 5250 MHz) : 21.38 dBm

5GHz (5725 - 5850 MHz) : 13.25 dBm

This equipment complies with CE radiation exposure limits set forth for an uncontrolled environment. This equipment should be installed and operated with a minimum distance of 20cm between the radiator & your body.

Contact as: <https://www.peplink.com/>

For Balance One Core, Balance 20, Balance 30 LTE, Balance 210, Balance 310X, Balance 310X 5G, Balance 310 5G, Balance 310 Fiber 5G, Balance 305, Balance 380, Balance 580, Balance 710, Balance 1350, Balance 2500, EPX, Balance SDX, MediaFast 500, MediaFast 750

Federal Communication Commission Interference Statement

This equipment has been tested and found to comply with the limits for a Class A digital device, pursuant to Part 15 of the FCC Rules. These limits are designed to provide reasonable protection against harmful interference when the equipment is operated in a commercial environment. This equipment generates, uses, and can radiate radio frequency energy, and if it is not installed and used in accordance with the instruction manual, it may cause harmful interference to radio communications. Operation of this equipment in a residential area is likely to cause harmful interference, in which case the user will be required to correct the interference at his own expense.

Any changes or modifications not expressly approved by the party responsible for compliance could void your authority to operate the equipment.

Radiation Exposure Statement (Balance 30 LTE, Balance 310X, Balance 310X 5G, Balance 310 5G, Balance 310 Fiber 5G)

This equipment complies with FCC RF radiation exposure limits set forth for an uncontrolled environment. This equipment should be installed and operated with a minimum distance of 20cm between the radiator and your body.

Industry Canada Statement (Balance One Core, Balance 20, Balance 30 LTE, Balance 310X, Balance 310X 5G, Balance 310 5G, Balance 310 Fiber 5G, Balance 305, Balance 380, Balance 580, Balance 710, Balance 1350, Balance 2500, EPX, Balance SDX, MediaFast 500, MediaFast 750)

This product meets the applicable Innovation, Science and Economic Development Canada technical specifications.

Le présent produit est conforme aux spécifications techniques applicables d'Innovation, Sciences et Développement économique Canada.

For Balance 30 LTE, Balance 310X, Balance 310X 5G, Balance 310 5G, Balance 310 Fiber 5G

This device contains licence-exempt transmitter(s)/receiver(s) that comply with Innovation, Science and Economic Development Canada's licence-exempt RSS(s). Operation is subject to the following two conditions:

- (1) This device may not cause interference.
- (2) This device must accept any interference, including interference that may cause undesired operation of the device.

Le present appareil est conforme aux CNR d'Industrie Canada applicables aux appareils radio exempts de licence. L'exploitation est autorisee aux deux conditions suivantes:

- (1) l'appareil ne doit pas produire de brouillage, et
- (2) l'utilisateur de l'appareil doit accepter tout brouillage radioelectrique subi, meme si le brouillage est susceptible d'en

Radiation Exposure Statement (Balance 30 LTE, Balance 310X, Balance 310X 5G, Balance 310 5G, Balance 310 Fiber 5G)

This device complies with the ISED radiation exposure limit set forth for an uncontrolled environment. This device should be installed and operated with minimum distance 20cm between the radiator & your body.

Cet équipement est conforme avec l'exposition aux radiations ISED définies pour un environnement non contrôlé. Cet équipement doit être installé et utilisé à une distance minimum de 20 cm entre le radiateur et votre corps.

Battery Caution Statement (Balance 30 LTE, Balance 210, Balance 310 5G, Balance 310X, Balance 310X 5G, Balance 310 Fiber 5G, Balance SDX, EPX, Balance One Core, Balance 305, Balance 380, Balance 580, Balance 710, Balance 1350, Balance 2500)

Risk of explosion if the battery replaced by an incorrect type, place the battery into fire, a hot oven, extremely high temperature or low air pressure surrounding environment, the leakage of flammable liquid or gas, and mechanically crushing or cutting of the battery.

Safety Statement (Balance SDX, EPX)

Class I Equipment. This equipment must be earthed. The power plug must be connected to a properly wired earth ground socket outlet. An improperly wired socket outlet could place hazardous voltages on accessible metal parts.

All Ethernet cables are designed for intra-building connection to other equipment. Do not connect these ports directly to communication wiring or other wiring that exits the building where the appliance is located.

FCC Requirements for Operation in the United States Federal Communications Commission (FCC) Compliance Notice:

For Balance Two

Federal Communication Commission Interference Statement

This equipment has been tested and found to comply with the limits for a Class B digital device, pursuant to part 15 of the FCC Rules. These limits are designed to provide reasonable protection against harmful interference in a residential installation. This equipment generates, uses and can radiate radio frequency energy and, if not installed and used in accordance with the instructions, may cause harmful interference to radio communications. However, there is no guarantee that interference will not occur in a particular installation. If this equipment does cause harmful interference to radio or television reception, which can be determined by turning the equipment off and on, the user is encouraged to try to correct the interference by one or more of the following measures:

- Reorient or relocate the receiving antenna.
- Increase the separation between the equipment and receiver.
- Connect the equipment into an outlet on a circuit different from that to which the receiver is connected.
- Consult the dealer or an experienced radio/TV technician for help.

Any changes or modifications not expressly approved by the party responsible for compliance could void your authority to operate the equipment.

Battery Caution Statement

Risk of explosion if the battery replaced by an incorrect type, place the battery into fire, a hot oven, extremely high temperature or low air pressure surrounding environment, the leakage of flammable liquid or gas, and mechanically crushing or cutting of the battery.

FCC Requirements for Operation in the United States Federal Communications Commission (FCC) Compliance Notice:

For Balance 20X

Federal Communication Commission Interference Statement

This equipment has been tested and found to comply with the limits for a Class A digital device, pursuant to Part 15 of the FCC Rules. These limits are designed to provide reasonable protection against harmful interference when the equipment is operated in a commercial environment. This equipment generates, uses, and can radiate radio frequency energy, and if it is not installed and used in accordance with the instruction manual, it may cause harmful interference to radio communications. Operation of this equipment in a residential area is likely to cause harmful interference, in which case the user will be required to correct the interference at his own expense.

Any changes or modifications not expressly approved by the party responsible for compliance could void your authority to operate the equipment.

Radiation Exposure Statement

This equipment complies with FCC RF radiation exposure limits set forth for an uncontrolled environment. This equipment should be installed and operated with a minimum distance of 20 cm between the radiator and your body.

Industry Canada Statement (Balance 20X)

This product meets the applicable Innovation, Science and Economic Development Canada technical specifications.

Le présent produit est conforme aux spécifications techniques applicables d'Innovation, Sciences et Développement économique Canada.

This device contains licence-exempt transmitter(s)/receiver(s) that comply with Innovation, Science and Economic Development Canada's licence-exempt RSS(s). Operation is subject to the following two conditions:

- (1) This device may not cause interference.
- (2) This device must accept any interference, including interference that may cause undesired operation of the device.

Le présent appareil est conforme aux CNR d'Industrie Canada applicables aux appareils radio exempts de licence. L'exploitation est autorisée aux deux conditions suivantes:

- (1) l'appareil ne doit pas produire de brouillage, et
- (2) l'utilisateur de l'appareil doit accepter tout brouillage radioelectrique subi, meme si le brouillage est susceptible d'en

(i) The device for operation in the band 5150-5250 MHz is only for indoor use to reduce the potent for harmful interference to co-channel mobile satellite systems

(ii) For devices with detachable antenna(s), the maximum antenna gain permitted for devices in band 5725-5850 MHz shall be such that the equipment still complies with the e.i.r.p. limits specified for point-to-point and non-point-to-point operation as appropriate and
The high-power radars are allocated as primary users (i.e. priority users) of the band 5725-5850 MHz and that these radars could cause interference and/or damage to LE-LAN devices.

(i) Le dispositif fonctionnant dans la bande 5150-5250 MHz est reserve uniquement pour utilisation a l'interieur afin de reduire les risques de brouillage prejudiciable aux systemes de satellites mobiles utilisant les memes canaux

(ii) Le gain maximal d'antenne permis pour les dispositifs avec antenne(s) amovible(s) utilisant bande 5725-5850 MHz doit se conformer a la limitation P.I.R.E specifiee pour l'exploitation point a point et non point a point, selon le cas.

En outre, les utilisateurs devraient aussi etre avises que les utilisateurs de radars de haute puissance sont designes utilisateurs principaux (c.-a-d., qu'ils ont la priorite) pour les bande 5725-5850 MHz et que ces radars pourraient causer du brouillage et/ou des dommages aux dispositifs LAN-EL.

Radiation Exposure Statement

This device complies with the ISED radiation exposure limit set forth for an uncontrolled environment. This device should be installed and operated with minimum distance 20cm between the radiator & your body.

Cet equipement est conforme avec l'exposition aux radiations ISED definies pour un environnement non controle. Cet equipement doit etre installe et utilise a une distance minimum de 20 cm entre le radiateur et votre corps.

Battery Caution Statement

Risk of explosion if the battery replaced by an incorrect type, place the battery into fire, a hot oven, extremely high temperature or low air pressure surrounding environment, the leakage of flammable liquid or gas, and mechanically crushing or cutting of the battery.

CE Statement for Pepwave Routers (Balance One Core)

DECLARATION OF CONFORMITY

We affirm the electrical equipment manufactured by us fulfils the requirements of the Radio Equipment Directive 2014/53/EU.

Name of manufacturer	Pismo Labs Technology Limited
Contact information of the manufacturer	Unit A5, 5/F, HK Spinners Ind. Bldg., Phase 6, 481 Castle Peak Road, Cheung Sha Wan, Kowloon, Hong Kong tel. (852) 2990 7600, fax. (852) 3007 0588 e-mail: cs@peplink.com
Description of the appliance	Peplink / Pepwave / Pismo wireless product
Model name of the appliance	Balance One Core
Trade name of the appliance	Pepwave / Peplink / Pismo

The construction of the appliance is in accordance with the following standards:

EN 55032:2015

EN 55024:2010+A1:2015

EN 61000-3-2:2014

EN 61000-3-3:2013

EN 60950-1:2006+A11:2009+A1:2010+A12:2011+A2:2013

Yours sincerely,

A handwritten signature in blue ink, followed by a circular purple stamp. The stamp contains the text "PEPLINK INTERNATIONAL LIMITED" around the perimeter.

Keith Chau
General Manager
Peplink International Limited

CE Statement for Pepwave Routers (Balance Two)

DECLARATION OF CONFORMITY

We affirm the electrical equipment manufactured by us fulfils the requirements of the Electromagnetic Compatibility Directive 2014/30/EU, and Low Voltage Directive 2014/35/EU.

Name of manufacturer	PISMO LABS TECHNOLOGY LIMITED
Contact information of the manufacturer	A8, 5/F, HK Spinners Industrial Building, Phase 6, 481 Castle Peak Road, Cheung Sha Wan, Kowloon, Hong Kong tel. (852) 2990 7600, fax. (852) 3007 0588 e-mail: cs@peplink.com
Description of the appliance	PEPWAVE / PEPLINK Balance Product Dual-WAN Router
Model name of the appliance	Balance Two BPL-TWO PismoX09A
Trade name of the appliance	PEPWAVE / PEPLINK

The construction of the appliance is in accordance with the following standards:

EN 55032: 2015 + AC:2016

EN 61000-3-2: 2014

EN 61000-3-3: 2013

EN 55035: 2017

IEC 62368-1:2014 (Second Edition) and/or EN 62368-1:2014

Yours sincerely,



Antony Chong
Director of Hardware Engineering
Peplink International Limited

CE Statement for Pepwave Routers (Balance 20X)

DECLARATION OF CONFORMITY

We affirm the electrical equipment manufactured by us fulfils the requirements of the Radio Equipment Directive 2014/53/EU.

Name of manufacturer	PISMO LABS TECHNOLOGY LIMITED
Contact information of the manufacturer	A8, 5/F, HK Spinners Industrial Building Phase 6, 481 Castle Peak Road Cheung Sha Wan Hong Kong tel. (852) 2990 7600, fax. (852) 3007 0588 e-mail: cs@peplink.com
Description of the appliance	PEPWAVE / PEPLINK Wireless Product
Model name of the appliance	Balance 20X B20X Surf SOHO Surf SOHO LTE Surf SOHO LTEA Balance 20X LTE Balance 20X LTEA PismoAC8E BPL-021X-LTE-E-T BPL-021X-LTEA-W-T EXM-MINI-1LTEA-W EXM-MINI-1LTEA-P PismoAC8P PismoAC8
Trade name of the appliance	PEPWAVE / PEPLINK

The construction of the appliance is in accordance with the following standards:

- EN 300 328 V2.1.1
- EN 301 893 V2.1.1
- EN 301908-1 V11.1.1
- Draft EN 301 489-1 V2.2.1
- Draft EN 301 489-17 V3.2.0
- Draft EN 301 489-52 V1.1.0
- EN 55032: 2015 + AC:2016-07
- EN 61000-3-2: 2014
- EN 61000-3-3: 2013
- EN 55035: 2017
- EN 62311 : 2008
- EN 62368-1:2014/A11:2017
- EN 303 413 V1.1.1
- EN 301 489-19 V2.1.1

Yours sincerely,



Antony Chong
 Director of Hardware Engineering
 Peplink International Limited



AT	BE	BG	HR	CY	CZ	DK	EE	FI	FR	DE	EL	HU	IE
IT	LV	LT	LU	MT	NL	PL	PT	RO	SK	SI	ES	SE	UK(NI)

2.4GHz (2412 - 2472 MHz) : 19.84 dBm

5GHz (5150 - 5250 MHz) : 22.89 dBm

WWAN : Refer 3GPP TS 36.521 -1 (UE Power class)

Table 4-6: Conducted Tx (Transmit) Power Tolerances

Parameter	Conducted transmit power	Notes
LTE		
LTE Band 1,3,8,20	+23 dBm ± 1 dB	
LTE Band 7	+22 dBm ± 1 dB	
UMTS		
Band 1 (IMT 2100 12.2 kbps) Band 3 (UMTS 1800 12.2 kbps) Band 8 (UMTS 900 12.2 kbps)	+23 dBm ± 1 dB	Connectorized (Class 3)

This equipment complies with CE radiation exposure limits set forth for an uncontrolled environment. This equipment should be installed and operated with a minimum distance of 20cm between the radiator & your body.

contact as: <https://www.peplink.com/>

CE Statement for Pepwave Routers (Balance 30 LTE)

DECLARATION OF CONFORMITY

We affirm the electrical equipment manufactured by us fulfils the requirements of the Radio Equipment Directive 2014/53/EU.

Name of manufacturer	PISMO LABS TECHNOLOGY LIMITED
Contact information of the manufacturer	A8, 5/F, HK Spinners Industrial Building, Phase 6, 481 Castle Peak Road, Cheung Sha Wan, Hong Kong tel. (852) 2990 7600, fax. (852) 3007 0588 e-mail: cs@peplink.com
Description of the appliance	PEPWAVE / PEPLINK Wireless Product
Model name of the appliance	Peplink Balance 30 LTE BPL-031-LTE-E-T Balance 30 LTE Pismo 811AC B30 LTE Peplink Balance 30
Trade name of the appliance	PEPWAVE / PEPLINK

The construction of the appliance is in accordance with the following standards:

- EN 301 908-1 V11.1.1
- Draft EN 301 489-1 V2.2.0
- Draft EN 301 489-52 V1.1.0
- EN 55032: 2015 + AC:2016
- EN 61000-3-2: 2014
- EN 61000-3-3: 2013
- EN 55035 : 2017
- EN 62311 : 2008
- EN 62368-1:2014/AC:2015

Yours sincerely,

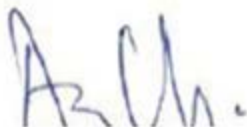

Antony Chong
 Director of Hardware Engineering
 Peplink International Limited



AT	BE	BG	HR	CY	CZ	DK	EE	FI	FR	DE	EL	HU	IE
IT	LV	LT	LU	MT	NL	PL	PT	RO	SK	SI	ES	SE	UK(NI)

WWAN : Refer 3GPP TS 36.521 -1 (UE Power class)

Output Power	Class 3 (23dBm±2dB) for LTE FDD Class 3 (23dBm±2dB) for LTE TDD Class 3 (24dBm +1/-3dB) for TD-SCDMA Class 3 (24dBm +1/-3dB) for UMTS Class E2 (27dBm ±3dB) for EDGE 850/900MHz Class E2 (26dBm +3/-4dB) for EDGE 1800/1900MHz Class 4 (33dBm ±2dB) for GSM 850/900MHz Class 1 (30dBm ±2dB) for GSM 1800/1900MHz
---------------------	---

This equipment complies with CE radiation exposure limits set forth for an uncontrolled environment. This equipment should be installed and operated with a minimum distance of 20cm between the radiator & your body.

contact as: <https://www.peplink.com/>

CE Statement for Pepwave Routers (Balance 210)

DECLARATION OF CONFORMITY

We affirm the electrical equipment manufactured by us fulfils the requirements of the Electromagnetic Compatibility Directive 2014/30/EU, and Low Voltage Directive 2014/35/EU.

Name of manufacturer	PISMO LABS TECHNOLOGY LIMITED
Contact information of the manufacturer	A8, 5/F, HK Spinners Industrial Building Phase 6, 481 Castle Peak Road Cheung Sha Wan Hong Kong tel. (852) 2990 7600, fax. (852) 3007 0588 e-mail: cs@peplink.com
Description of the appliance	PEPWAVE / PEPLINK Wireless Product
Model name of the appliance	Balance 210 Peplink 210 BPL-210 Peplink Balance Router 210 Peplink Balance SD-WAN Router Peplink Balance 210 Pismo 809
Trade name of the appliance	PEPWAVE / PEPLINK

The construction of the appliance is in accordance with the following standards:

EN 55032: 2015 + AC:2016-07
EN 61000-3-2: 2014
EN 61000-3-3: 2013
EN 55035: 2017
EN 62368-1:2014/A11:2017

Yours sincerely,



Antony Chong
Director of Hardware Engineering
Peplink International Limited

CE Statement for Pepwave Routers (Balance 310 5G)

DECLARATION OF CONFORMITY

We affirm the electrical equipment manufactured by us fulfils the requirements of the Radio Equipment Directive 2014/53/EU.

Name of manufacturer	PISMO LABS TECHNOLOGY LIMITED
Contact information of the manufacturer	A8, 5/F, HK Spinners Industrial. Building., Phase 6, 481 Castle Peak Road, Cheung Sha Wan, Kowloon, Hong Kong tel. (852) 2990 7600, fax. (852) 3007 0588 e-mail: cs@peplink.com
Description of the appliance	PEPWAVE / PEPLINK Wireless Product
Model name of the appliance	Balance 310 5G BPL-310-5GD-K-T BPL-310-5GH-K-T
Trade name of the appliance	PEPWAVE / PEPLINK

The construction of the appliance is in accordance with the following standards:

- EN 301 908-1 V13.1.1
- EN 301 489-1 V2.2.3
- Draft ETSI EN 301 489-52 V1.1.0
- EN 55032 : 2015 / A11:2020
- EN 55035 : 2017 / A11:2020
- EN 61000-3-2 : 2019
- EN 61000-3-3 : 2013/A1:2019
- EN 62311:2020
- IEC 62368-1:2018
- EN IEC 62368-1:2020+A11:2020
- BS EN IEC 62368-1:2020+A11:2020
- EN IEC 62368-3:2020

Yours sincerely,



Antony Chong
 Director of Hardware Engineering
 Peplink International Limited



AT	BE	BG	HR	CY	CZ	DK	EE	FI	FR	DE	EL	HU	IE
IT	LV	LT	LU	MT	NL	PL	PT	RO	SK	SI	ES	SE	UK(NI)

WWAN : Refer 3GPP TS 36.521 -1 (UE Power class)

EM7565 module:

Table 3-6: Conducted Tx (Transmit) Power Tolerances

Bands	Conducted Tx power	Notes
LTE		
LTE bands 1,3,8,20,28	+23 dBm ± 1 dB	
LTE bands 7	Single cell: +22 dBm ± 1 dB UL CA: +22.8 dBm ± 1 dB	0.8 dB offset for UL CA hardcoded by chipset manufacturer
UMTS		
Band 1 (IMT 2100 12.2 kbps) Band 8 (UMTS 900 12.2 kbps)	+23 dBm ± 1 dB	Connectorized (Class 3)

EM9191 module:

Table 4-11: Conducted Maximum Tx (Transmit) Power^a Tolerances

Bands	Conducted Tx Power	Notes
5G		
FR1 Sub-6G Bands	+23 dBm ± 1.5 dB	Power Class 3
LTE		
LTE B7, B38, B42	+23 dBm +1.8 dB/-1.0 dB	Power Class 3
LTE all other bands	+23 dBm ± 1 dB	Power Class 3
UMTS		
All bands (12.2 kbps)	+23.5 dBm ± 1 dB	Connectorized (Power Class 3)

a. Tx Power is based on no maximum power reduction (MPR) configuration as 3GPP defined. For configurations that require MPR or additional MPR, refer to 3GPP for the power reduction.

MV31-W module:

5G	Bands	FR1 (Sub 6G): FDD: n1, n3, n28 TDD: n41, n77, n78
	Band combinations	For supported E-UTRAN New Radio Dual Connectivity (EN-DC) see Section 6.2
	4x4 MIMO	n1, n3, n41, n77, n78,
	DSS	n1, n3
	Category	3GPP Rel 15
	Output Power	FR1 (Sub 6G): n41, n77, n78: 26dBm +2/-3dB all other bands: 23dBm ±2dB
4G	Bands	FDD: B1, B3, B7, B8, B20, B28 TDD: B34, B42
	Band combinations	For supported carrier aggregations (CA) see Section 6.1
	4x4 MIMO	B1, B3, B7, B38, B42
	RX Diversity	all LTE bands
	Category	UE Cat. 13 (UL: 150Mbps) + UE Cat. 20 (DL: 2Gbps); 7xDL CA, 3xUL CA (Intra-band), 5xDL CA+4X4 MIMO (Up to UE Cat20)
	Output Power	all bands: 23dBm ±2dB
3G	Bands	Bd.I, Bd.VIII
	RX Diversity	all 3G bands
	Category	DC-HSPA+ – DL Cat. 24 (42Mbps) / UL Cat. 6 (11Mbps) HSUPA – UL 5.76Mbps Compressed mode (CM) supported according to 3GPP TS25.212
	Output Power	all bands: 24dBm +1.7/-3.7dB

This equipment complies with CE radiation exposure limits set forth for an uncontrolled environment. This equipment should be installed and operated with a minimum distance of 21cm between the radiator & your body.

contact as: <https://www.peplink.com/>

CE Statement for Pepwave Routers (Balance 310X 5G)

DECLARATION OF CONFORMITY

We affirm the electrical equipment manufactured by us fulfils the requirements of the Radio Equipment Directive 2014/53/EU.

Name of manufacturer	PISMO LABS TECHNOLOGY LIMITED
Contact information of the manufacturer	A8, 5/F, HK Spinners Industrial. Building., Phase 6, 481 Castle Peak Road, Cheung Sha Wan, Kowloon, Hong Kong tel. (852) 2990 7600, fax. (852) 3007 0588 e-mail: cs@peplink.com
Description of the appliance	PEPWAVE / PEPLINK Wireless Product
Model name of the appliance	MAX HD2 MBX 5G MAX-HD2-MBX-5GD-T MAX HD4 MBX 5G MAX-HD4-MBX-5GD-T Balance 310X Balance 310X 5G BPL-310X-5GD-T MBX Expansion Module Expansion Module with 1x 5G modems EXM-310X-5GD Expansion Module with 4x 5G modems EXM-MBX-T4-5GD Expansion Module with 2x 5G modules EXM-MBX-T2-5GD
Trade name of the appliance	PEPWAVE / PEPLINK

The construction of the appliance is in accordance with the following standards:

EN 301 908-1 V13.1.1
EN 300 328 V2.2.2
EN 301 893 V2.1.1
EN 303 413 V1.1.1
EN 62311: 2020
EN 301 489-1 V2.2.3
EN 301 489-17 V3.2.4
Draft EN 301 489-19 V2.2.0
Draft EN 301 489-52 V1.1.2
EN 55032: 2015 / A11: 2020
EN 55035: 2017 / A11: 2020
EN 61000-3-2: 2014
EN 61000-3-3: 2013 / A1:2019
EN 62368-1:2020 + A11:2020

Yours sincerely,



Antony Chong
Director of Hardware Engineering
Peplink International Limited

CE Statement for Pepwave Routers (Balance 310 Fiber 5G)

DECLARATION OF CONFORMITY

We affirm the electrical equipment manufactured by us fulfils the requirements of the Radio Equipment Directive 2014/53/EU.

Name of manufacturer	PISMO LABS TECHNOLOGY LIMITED
Contact information of the manufacturer	A8, 5/F, HK Spinners Industrial. Building., Phase 6, 481 Castle Peak Road, Cheung Sha Wan, Kowloon, Hong Kong tel. (852) 2990 7600, fax. (852) 3007 0588 e-mail: cs@peplink.com
Description of the appliance	PEPWAVE / PEPLINK Wireless Product
Model name of the appliance	Balance 310 Fiber 5G BPL-310-FBR-5GD-T-PRM
Trade name of the appliance	PEPWAVE / PEPLINK

The construction of the appliance is in accordance with the following standards:

EN 300 328 V2.2.2
EN 301 893 V2.1.1
EN 301 908-1 V13.1.1
EN 62311: 2020
EN 301 489-1 V2.2.3
EN 301 489-17 V3.2.4
Draft EN 301 489-52 V1.1.2
EN 55032: 2015 / A11:2020
EN 55035: 2017 / A11:2020
EN 61000-3-2: 2014
EN 61000-3-3: 2013 / A1:2019
EN 62368-1:2020 + A11:2020

Yours sincerely,



Antony Chong
Director of Hardware Engineering
Peplink International Limited



AT	BE	BG	HR	CY	CZ	DK	EE	FI	FR	DE	EL	HU	IE
IT	LV	LT	LU	MT	NL	PL	PT	RO	SK	SI	ES	SE	UK(NI)

2.4GHz (2412 – 2472 MHz) : 19.94 dBm

5GHz (5150 - 5250 MHz) : 22.76 dBm

WWAN : Refer 3GPP TS 36.521 -1 (UE Power class)

5G	Bands	FR1 (Sub 6G): FDD: n28 TDD: n78
	Band combinations	For supported E-UTRAN New Radio Dual Connectivity (EN-DC) see Section 6.2
	4x4 MIMO	n78
	DSS	n28
	Category	3GPP Rel 15
	Output Power	FR1 (Sub 6G): n78: 26dBm +2/-3dB all other bands: 23dBm ±2dB
4G	Bands	FDD: B1, B3, B7, B8, B20, B28 TDD: B38, B40
	Band combinations	For supported carrier aggregations (CA) see Section 6.1
	4x4 MIMO	B1, B3, B7, B40, B38
	RX Diversity	all LTE bands
	Category	UE Cat. 13 (UL: 150Mbps) + UE Cat. 20 (DL: 2Gbps); 7xDL CA, 3xUL CA (Intra-band), 5xDL CA+4X4 MIMO (Up to UE Cat20)
	Output Power	23dBm ±2dB
3G	Bands	Bd.I, Bd.VIII
	RX Diversity	all 3G bands
	Category	DC-HSPA+ – DL Cat. 24 (42Mbps) / UL Cat. 6 (11Mbps) HSUPA – UL 5.76Mbps Compressed mode (CM) supported according to 3GPP TS25.212
	Output Power	all bands: 24dBm +1.7/-3.7dB

This equipment complies with CE radiation exposure limits set forth for an uncontrolled environment. This equipment should be installed and operated with a minimum distance of 20cm between the radiator & your body.

contact as: <https://www.peplink.com/>

CE Statement for Pepwave Routers (Balance SDX)

DECLARATION OF CONFORMITY

We affirm the electrical equipment manufactured by us fulfils the requirements of the Radio Equipment Directive 2014/53/EU.

Name of manufacturer	PISMO LABS TECHNOLOGY LIMITED
Contact information of the manufacturer	A8, 5/F, HK Spinners Industrial Building, Phase 6, 481 Castle Peak Road, Cheung Sha Wan, Hong Kong tel. (852) 2990 7600, fax. (852) 3007 0588 e-mail: cs@peplink.com
Description of the appliance	PEPWAVE / PEPLINK Wireless Product
Model name of the appliance	Peplink Balance SDX SDX Main Chassis (BPL-SDX) SDX Main Chassis (BPL-SDX-F1) SDX Main Chassis (BPL-SDX-C1) BPL-SDX BPL-SDX-F1 BPL-SDX-C1
Trade name of the appliance	PEPWAVE / PEPLINK

The construction of the appliance is in accordance with the following standards:

- EN 55032: 2015 + AC:2016
- EN 61000-3-2: 2014
- EN 61000-3-3: 2013
- EN 55035 : 2017
- EN 62368-1:2014+A11:2017

Yours sincerely,



Antony Chong
 Director of Hardware Engineering
 Peplink International Limited



AT	BE	BG	HR	CY	CZ	DK	EE	FI	FR	DE	EL	HU	IE
IT	LV	LT	LU	MT	NL	PL	PT	RO	SK	SI	ES	SE	UK(NI)

contact as: <https://www.peplink.com/>

CE Statement for Pepwave Routers (EPX)

DECLARATION OF CONFORMITY

We affirm the electrical equipment manufactured by us fulfils the requirements of the Radio Equipment Directive 2014/53/EU.

Name of manufacturer	PISMO LABS TECHNOLOGY LIMITED
Contact information of the manufacturer	A8, 5/F, HK Spinners Ind. Bldg., Phase 6, 481 Castle Peak Road, Cheung Sha Wan, Kowloon, Hong Kong tel. (852) 2990 7600, fax. (852) 3007 0588 e-mail: cs@peplink.com
Description of the appliance	SD-WAN Router
Model name of the appliance (or selective Product Codes)	EPX EPX-M8
Trade name of the appliance	PEPWAVE / PEPLINK

The construction of the appliance is in accordance with the following standards:

EN 55032: 2015 +AC: 2016

EN 61000-3-2: 2014

EN 61000-3-3: 2013

EN 61000-4-2: 2009

EN 61000-4-3: 2006 +A1: 2008 + A2: 2010

EN 61000-4-4: 2012

EN 61000-4-5: 2014

EN 61000-4-6:2014

EN 61000-4-11:2004

EN 301 489-1 V2.1.1

EN 62368-1:2014+A11:2017

Yours sincerely,



Keith Chau
General Manager
Peplink International Limited



AT	BE	BG	HR	CY	CZ	DK	EE	FI	FR	DE	EL	HU	IE
IT	LV	LT	LU	MT	NL	PL	PT	RO	SK	SI	ES	SE	UK(NI)

contact as: <https://www.peplink.com/>

FCC Requirements for Operation in the United States

Federal Communications Commission (FCC) Compliance Notice:

For Balance SDX Pro

Federal Communication Commission Interference Statement

This equipment has been tested and found to comply with the limits for a Class A digital device, pursuant to Part 15 of the FCC Rules. These limits are designed to provide reasonable protection against harmful interference when the equipment is operated in a commercial environment. This equipment generates, uses, and can radiate radio frequency energy, and if it is not installed and used in accordance with the instruction manual, it may cause harmful interference to radio communications. Operation of this equipment in a residential area is likely to cause harmful interference, in which case the user will be required to correct the interference at his own expense.

Any changes or modifications not expressly approved by the party responsible for compliance could void your authority to operate the equipment.

Industry Canada Statement (Balance SDX Pro)

This product meets the applicable Innovation, Science and Economic Development Canada technical Specifications.

Le présent produit est conforme aux spécifications techniques applicables d'Innovation, Sciences et Développement économique Canada.

Battery Caution Statement (Balance SDX Pro)

Risk of explosion if the battery replaced by an incorrect type, place the battery into fire, a hot oven, extremely high temperature or low air pressure surrounding environment, the leakage of flammable liquid or gas, and mechanically crushing or cutting of the battery.

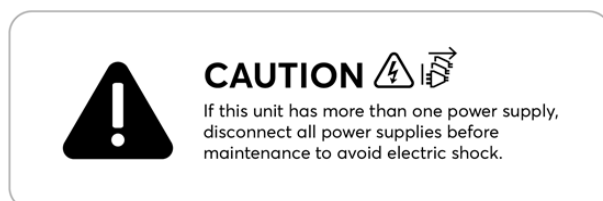

This caution label show on bottom of device for Balance SDX Pro and EPX models, and near power supply position.

CE Statement for Pepwave Routers (Balance SDX Pro)

DECLARATION OF CONFORMITY

We affirm the electrical equipment manufactured by us fulfils the requirements of the Radio Equipment Directive 2014/53/EU.

Name of manufacturer	PISMO LABS TECHNOLOGY LIMITED
Contact information of the manufacturer	A8, 5/F, HK Spinners Industrial. Building., Phase 6, 481 Castle Peak Road, Cheung Sha Wan, Kowloon, Hong Kong tel. (852) 2990 7600, fax. (852) 3007 0588 e-mail: cs@peplink.com
Description of the appliance	PEPWAVE / PEPLINK Balance Product
Model name of the appliance	Balance SDX Pro BPL-SDX-PRO-M2 BPL-SDX-PRO-M2-1TB BPL-SDX-PRO-M2-2TB Peplink Balance SDX Pro
Trade name of the appliance	PEPWAVE / PEPLINK

The construction of the appliance is in accordance with the following standards:

EN 55032: 2015 + A11:2020
EN 55035: 2017 + A11:2020
EN 61000-3-2: 2014
EN 61000-3-3: 2013
EN 62368-1:2014 + A11:2017

Yours sincerely,



Antony Chong
Director of Hardware Engineering
Peplink International Limited



AT	BE	BG	HR	CY	CZ	DK	EE	FI	FR	DE	EL	HU	IE
IT	LV	LT	LU	MT	NL	PL	PT	RO	SK	SI	ES	SE	UK(NI)

contact as: <https://www.peplink.com/>

FCC Requirements for Operation in the United States

Federal Communications Commission (FCC) Compliance Notice:

For Balance 380X, Balance 580X

Federal Communication Commission Interference Statement

This equipment has been tested and found to comply with the limits for a Class A digital device, pursuant to Part 15 of the FCC Rules. These limits are designed to provide reasonable protection against harmful interference when the equipment is operated in a commercial environment. This equipment generates, uses, and can radiate radio frequency energy, and if it is not installed and used in accordance with the instruction manual, it may cause harmful interference to radio communications. Operation of this equipment in a residential area is likely to cause harmful interference, in which case the user will be required to correct the interference at his own expense.

Any changes or modifications not expressly approved by the party responsible for compliance could void your authority to operate the equipment.

Industry Canada Statement (Balance 380X, Balance 580X)

This product meets the applicable Innovation, Science and Economic Development Canada technical specifications.

Ce produit répond aux spécifications techniques applicables à l'innovation, Science et Développement économique Canada.

Battery Caution Statement (Balance 380X, Balance 580X)

Risk of explosion if the battery replaced by an incorrect type, place the battery into fire, a hot oven, extremely high temperature or low air pressure surrounding environment, the leakage of flammable liquid or gas, and mechanically crushing or cutting of the battery.

CE Statement for Pepwave Routers (Balance 380X / Balance 580X)

DECLARATION OF CONFORMITY

We affirm the electrical equipment manufactured by us fulfils the requirements of the Radio Equipment Directive 2014/53/EU.

Name of manufacturer	PISMO LABS TECHNOLOGY LIMITED
Contact information of the manufacturer	A8, 5/F, HK Spinners Industrial. Building., Phase 6, 481 Castle Peak Road, Cheung Sha Wan, Kowloon, Hong Kong tel. (852) 2990 7600, fax. (852) 3007 0588 e-mail: cs@peplink.com
Description of the appliance	PEPWAVE / PEPLINK Wireless Product
Model name of the appliance	Balance 380X Balance 580X Peplink Balance 380X Peplink Balance 580X BPL-380X BPL-580X
Trade name of the appliance	PEPWAVE / PEPLINK

The construction of the appliance is in accordance with the following standards:

EN 55032: 2015 + A11:2020
EN 55035: 2017 + A11:2020
EN 61000-3-2: 2014
EN 61000-3-3: 2013
EN 62368-1:2014 + A11:2017

Yours sincerely,



Antony Chong
Director of Hardware Engineering
Peplink International Limited



AT	BE	BG	HR	CY	CZ	DK	EE	FI	FR	DE	EL	HU	IE
IT	LV	LT	LU	MT	NL	PL	PT	RO	SK	SI	ES	SE	UK(NI)

contact as: <https://www.peplink.com/>

USB WAN Modem Port Specification

Balance Series

	20X	30 LTE	30 Pro	ONE	TWO	210
Output Rating	5V DC, 2A	5V DC, 2A	5V DC, 2A	5V DC, 2A	5V DC, 1.5A	5V DC, 1A

	310X	380	380X	580	580X	710	1350	2500
Output Rating	5V DC, 0.5A	5V DC, 0.5A	5V DC, 1A	5V DC, 0.5A	5V DC, 1A	5V DC, 2.5A	5V DC, 2.5A	5V DC, 2.5A